

LEGO



8484



95



1

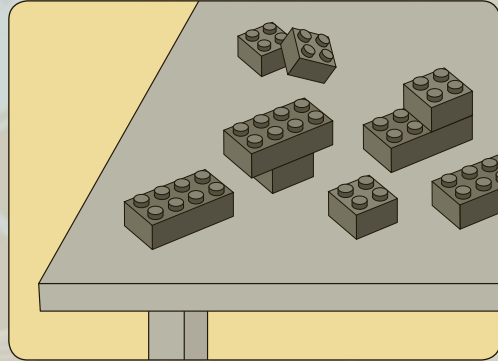
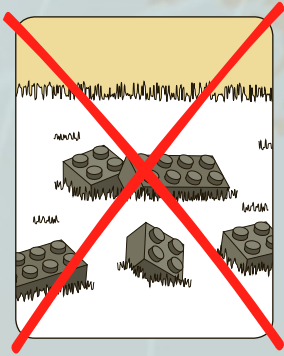

2





1

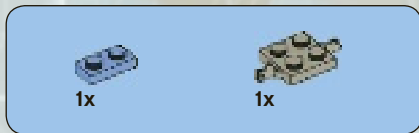

2





3

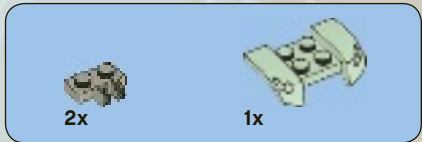
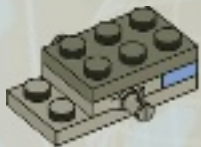

4





2x



1x

5



1x



1x

6

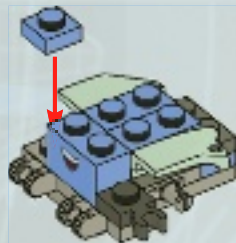



2x

7 *waypoint*

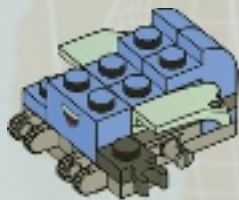

1x



2x

8

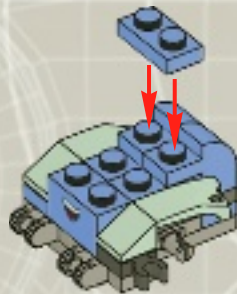



1x

9



1x

10

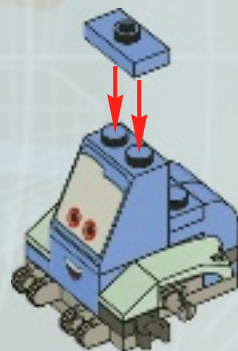



1x



2x

11



2x



2x

12

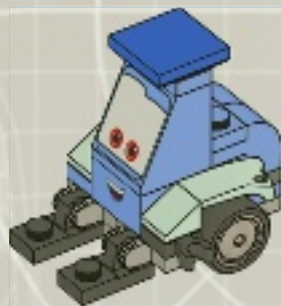

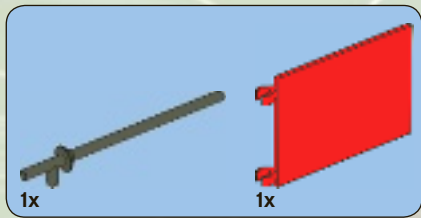

13

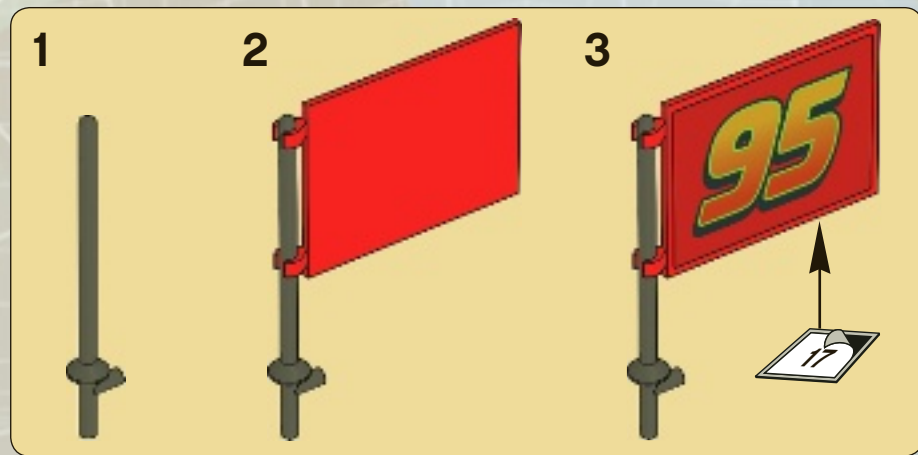



1





2

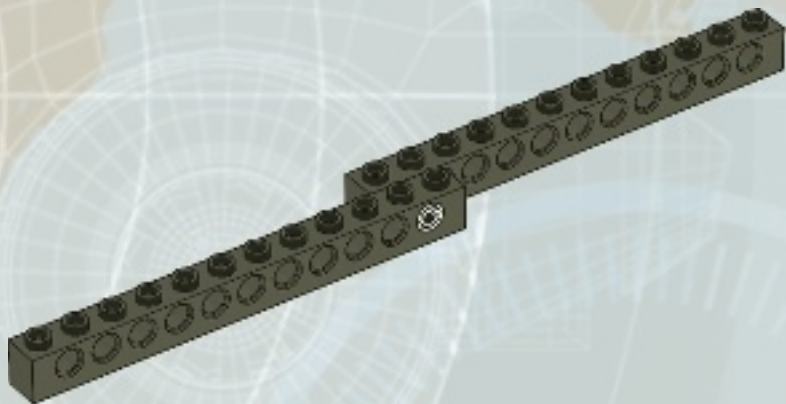



1x

3

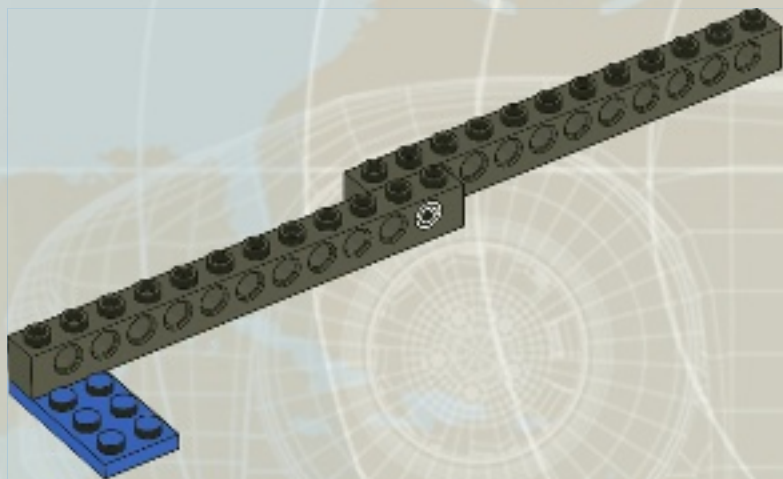



1x

4

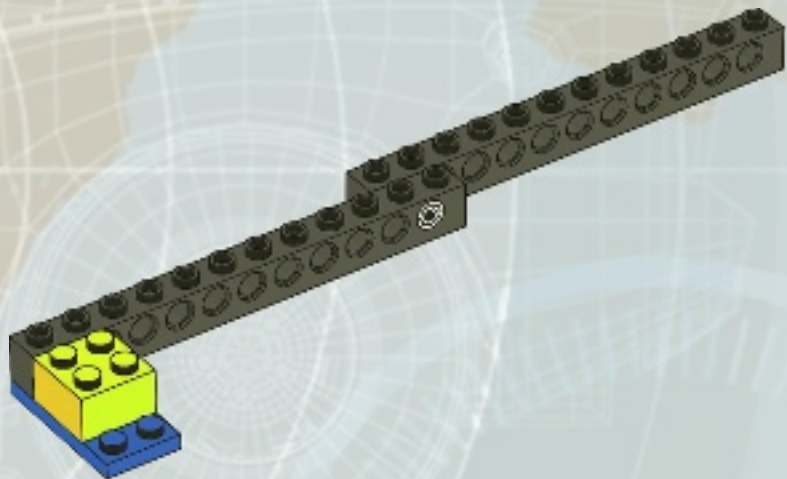



5

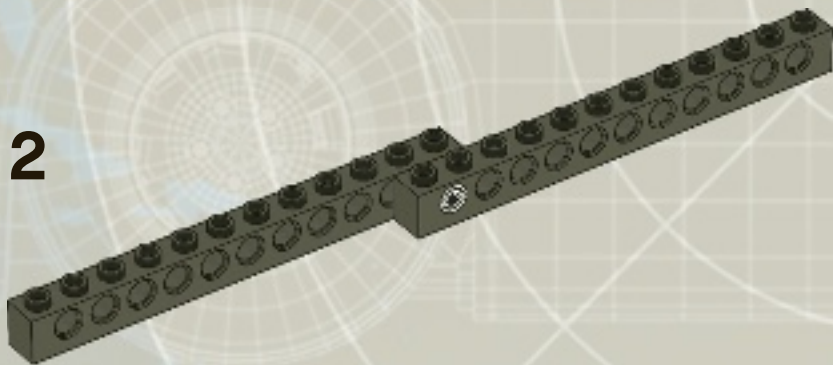

waypoint

2

target
acquired





6

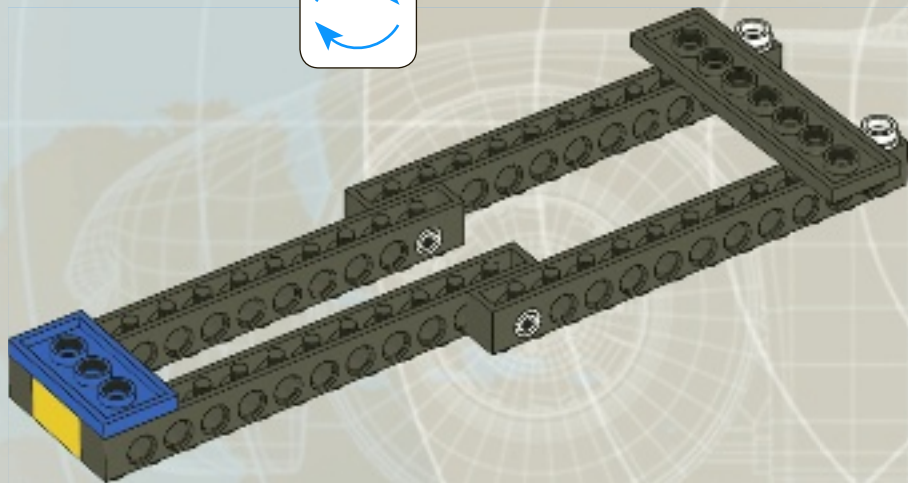



7

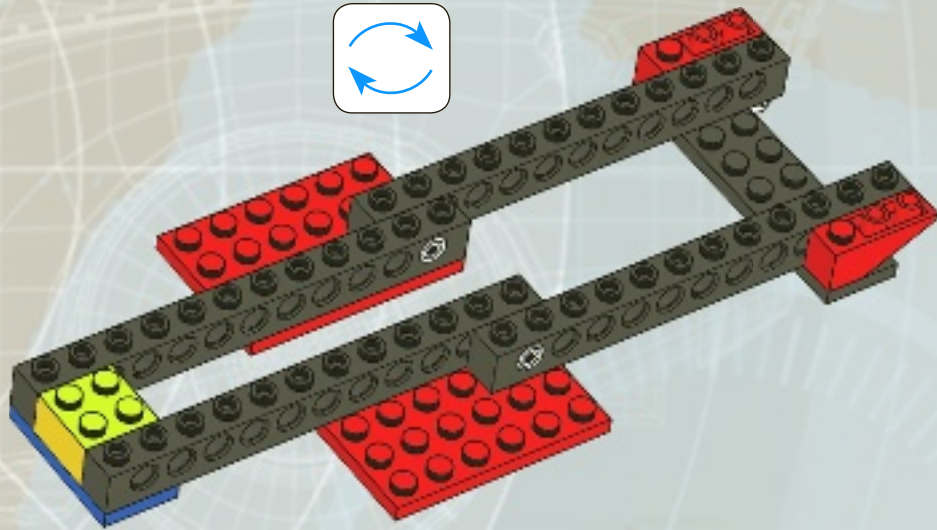

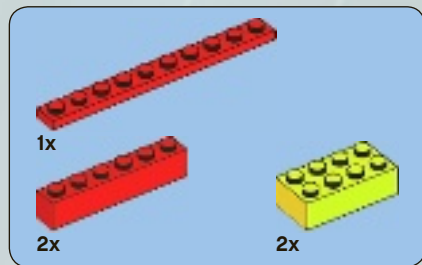

8

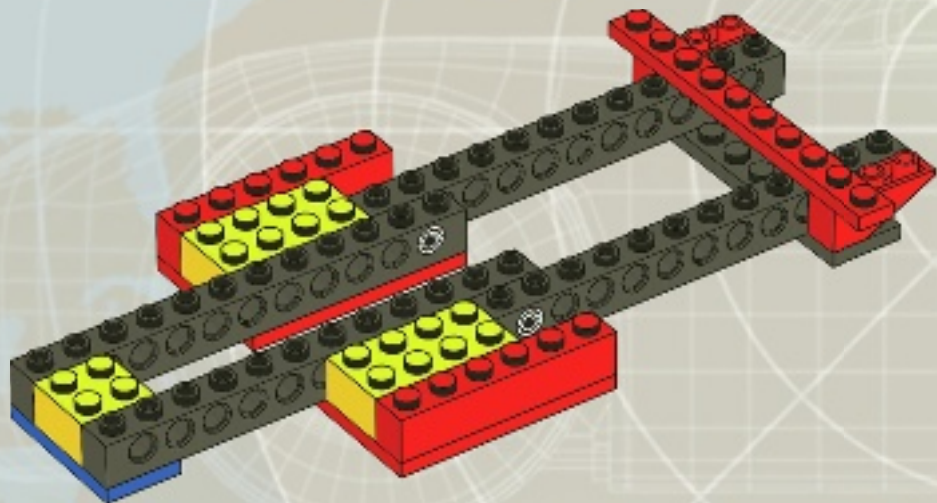

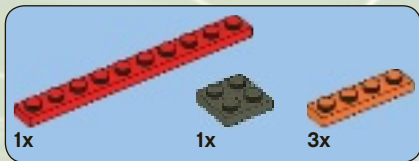

9

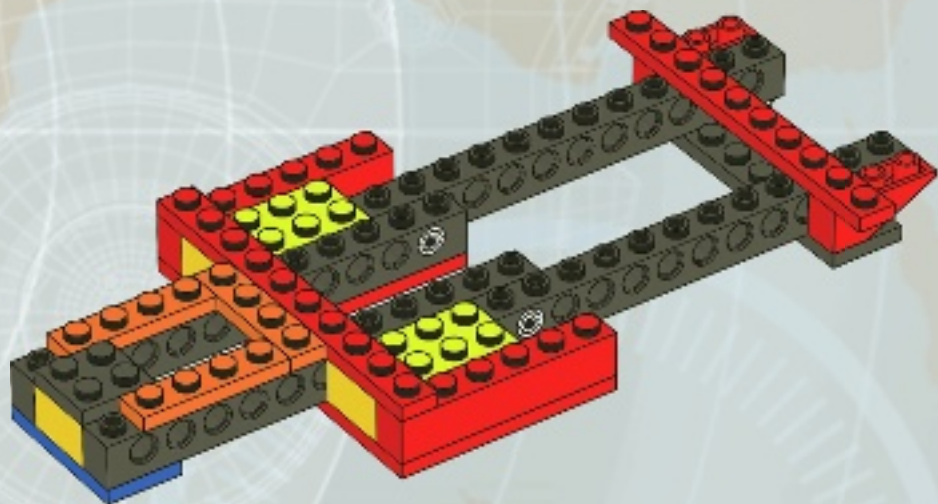

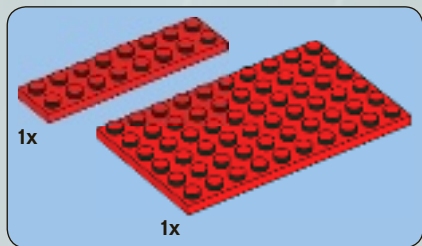

10

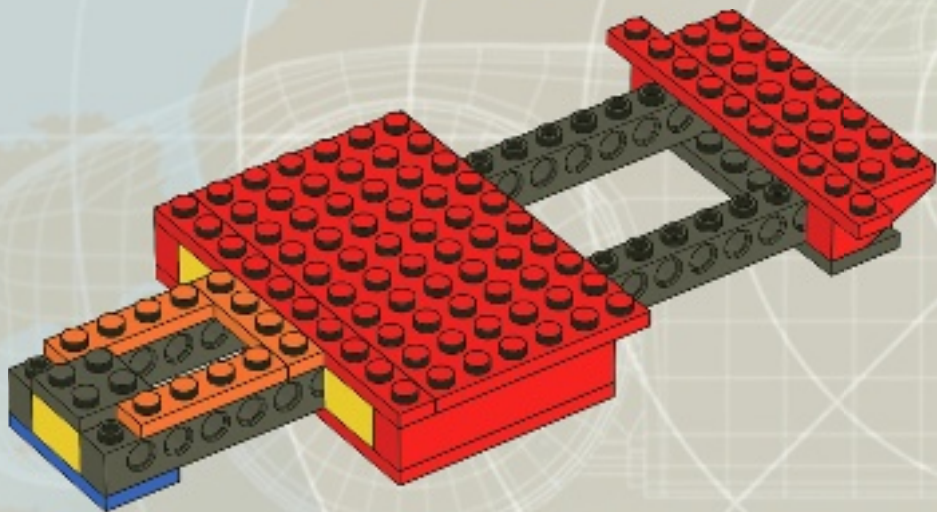

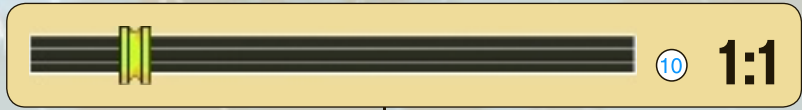
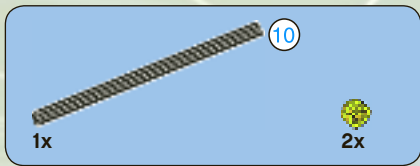

11

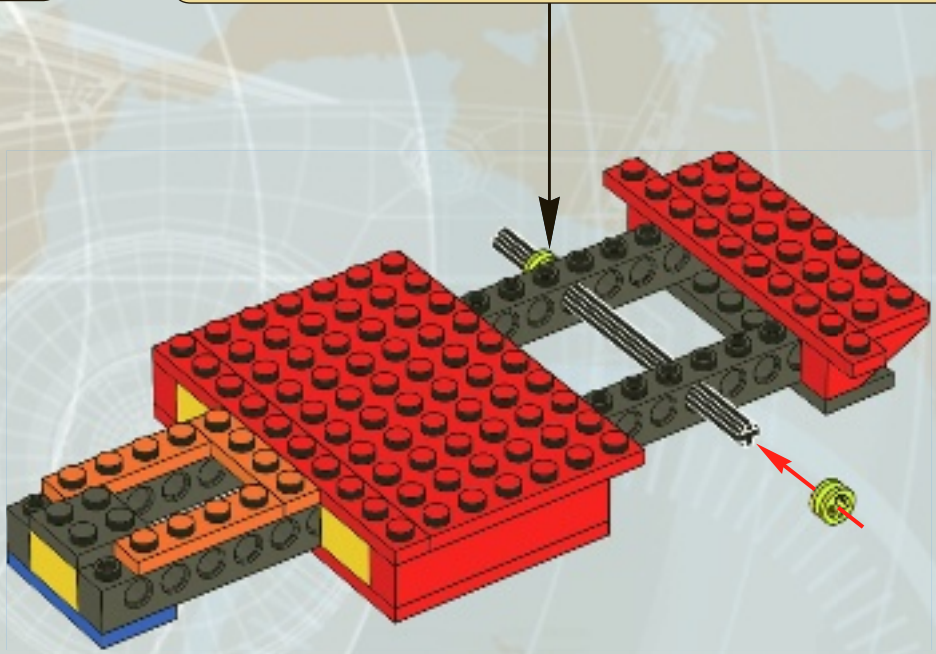

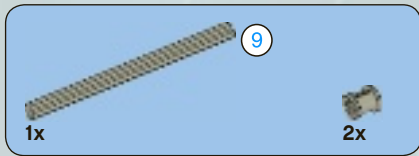

12

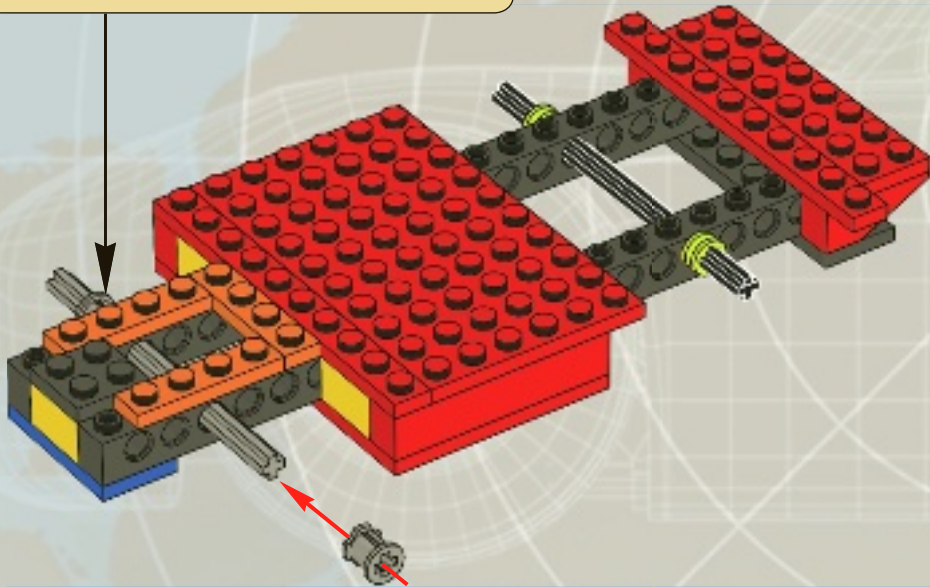

target
acquired

point 2

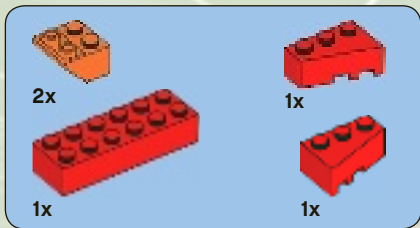

13

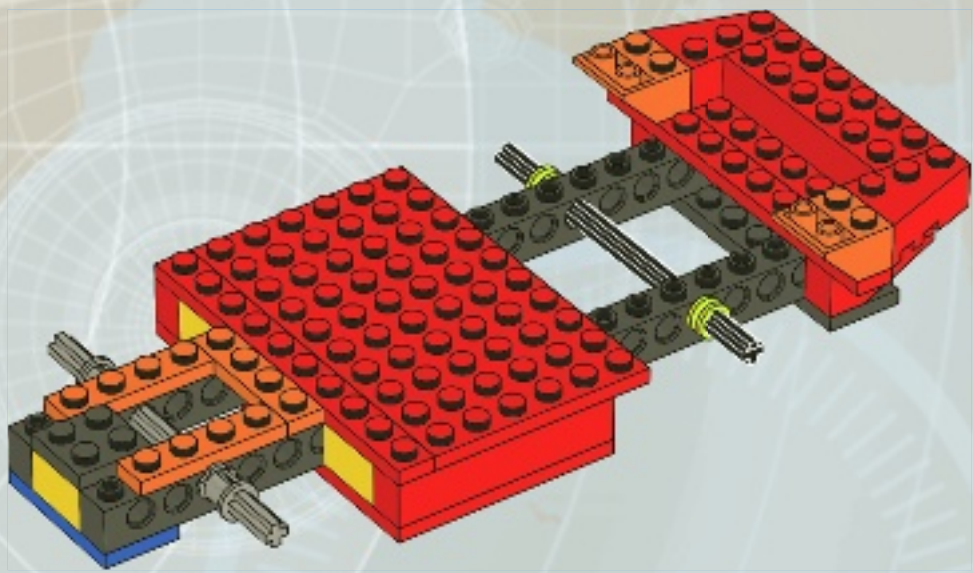

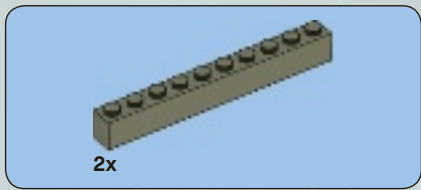

14

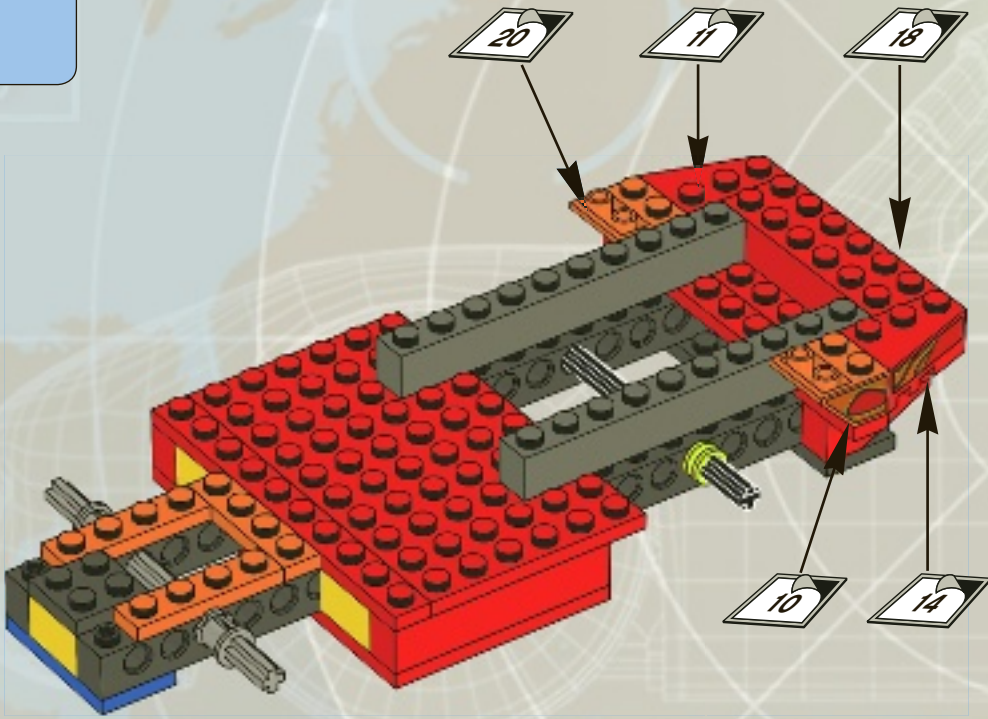



2x



2x



1x

15

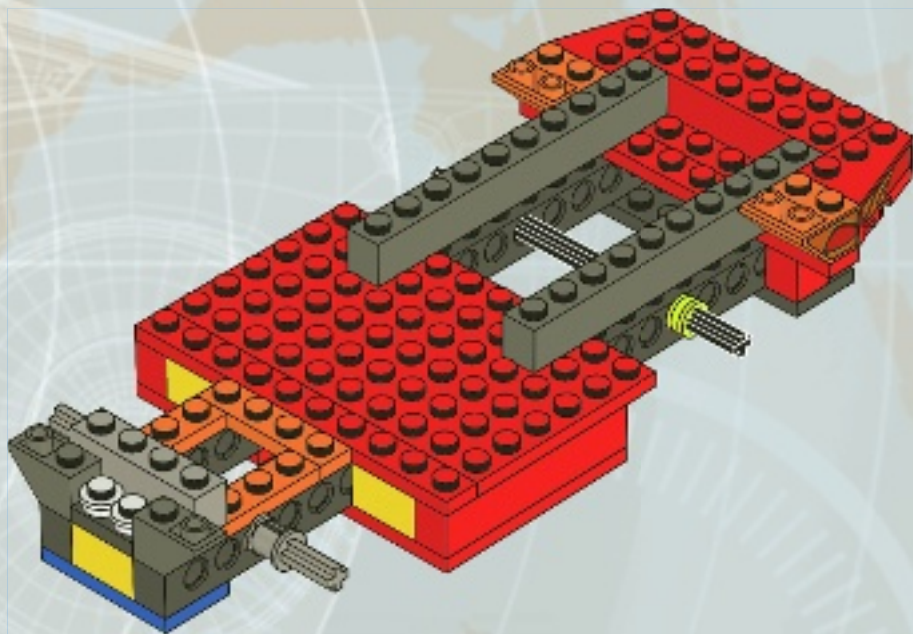



1x



2x



1x

16

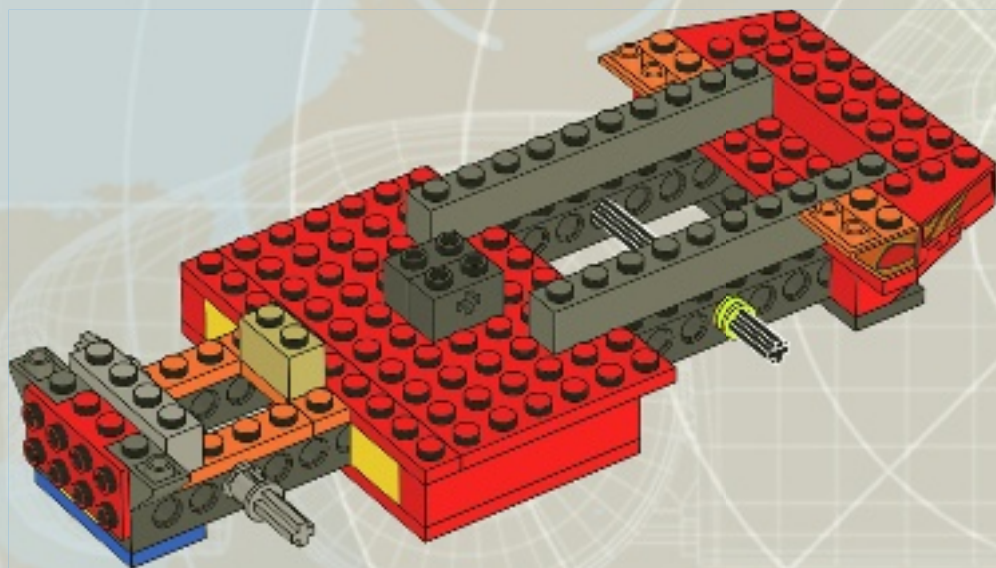

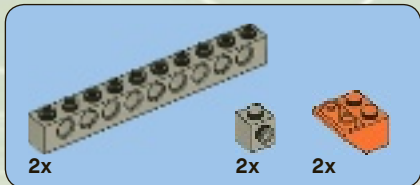

17

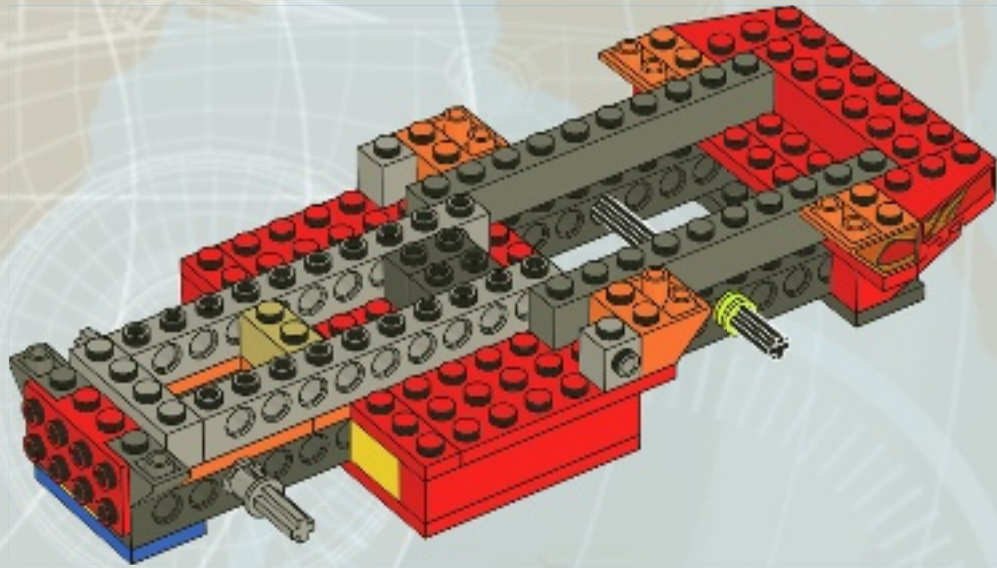

point 2
target acquired

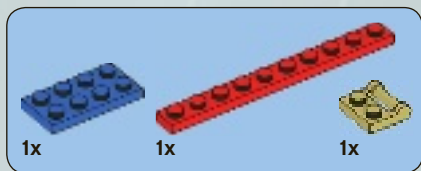

18

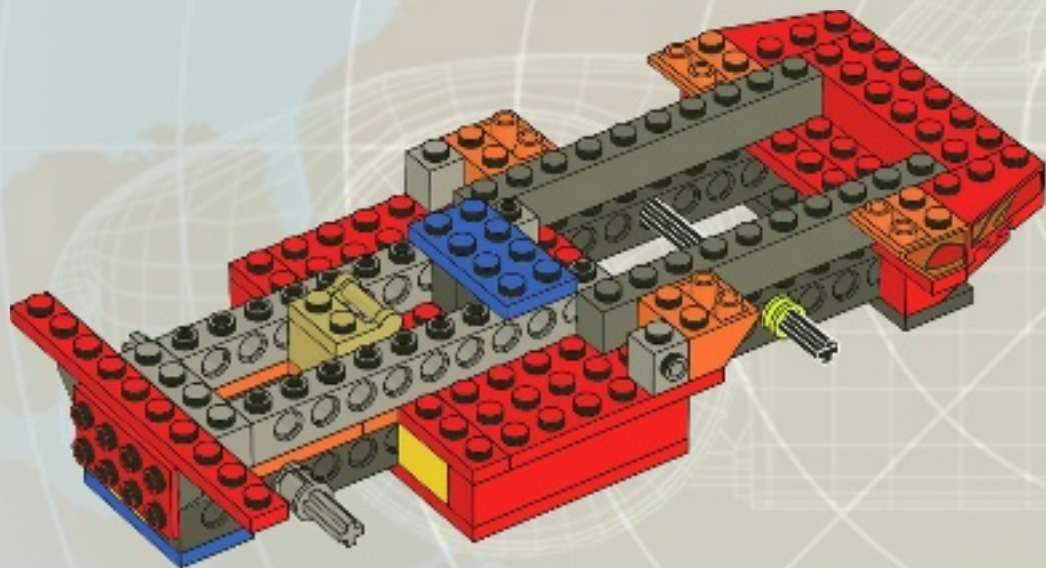

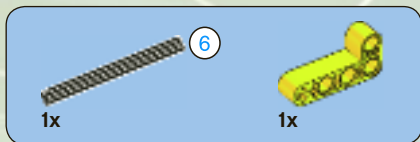

19

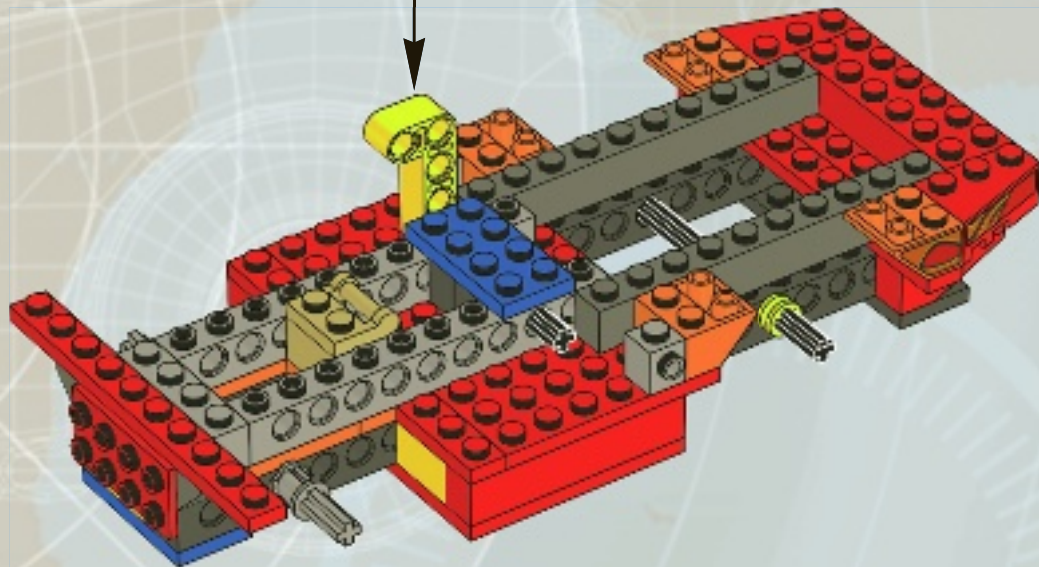
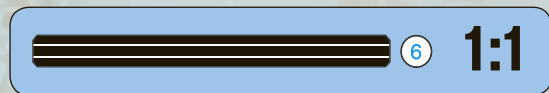
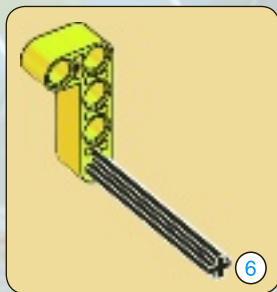



1x

20

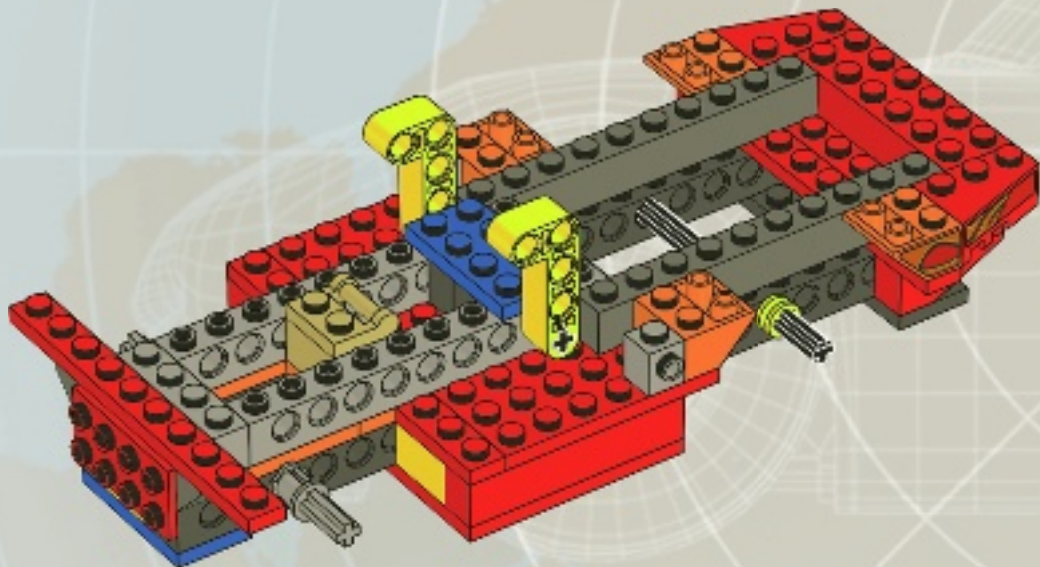



2x



2x

21

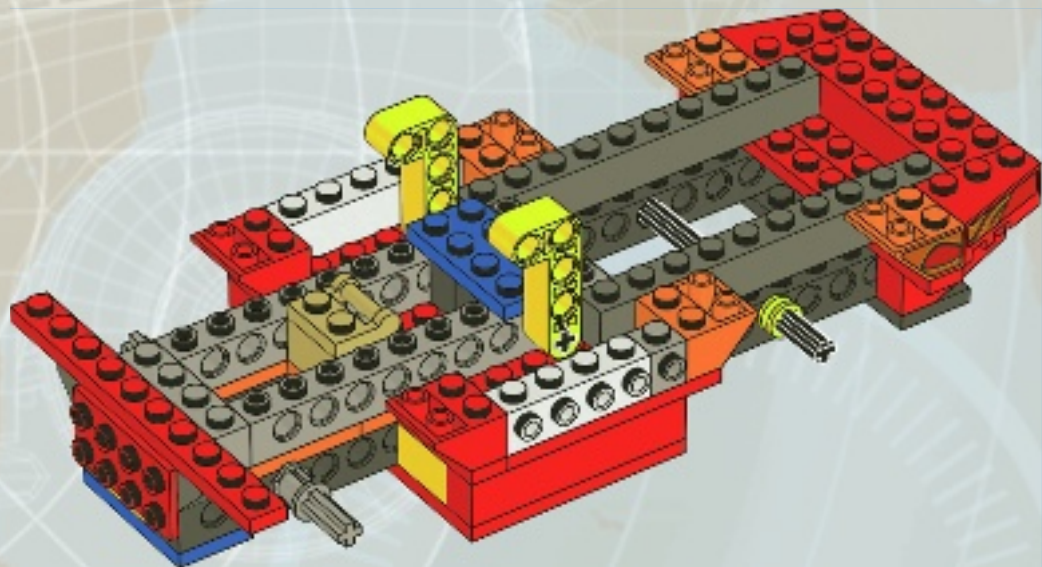



2x



2x

22

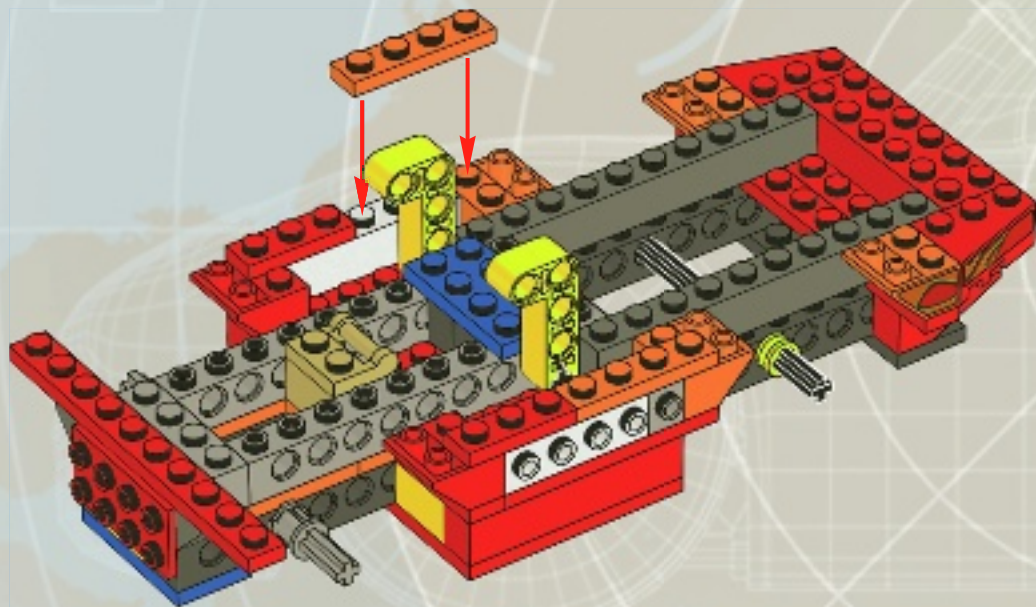



23

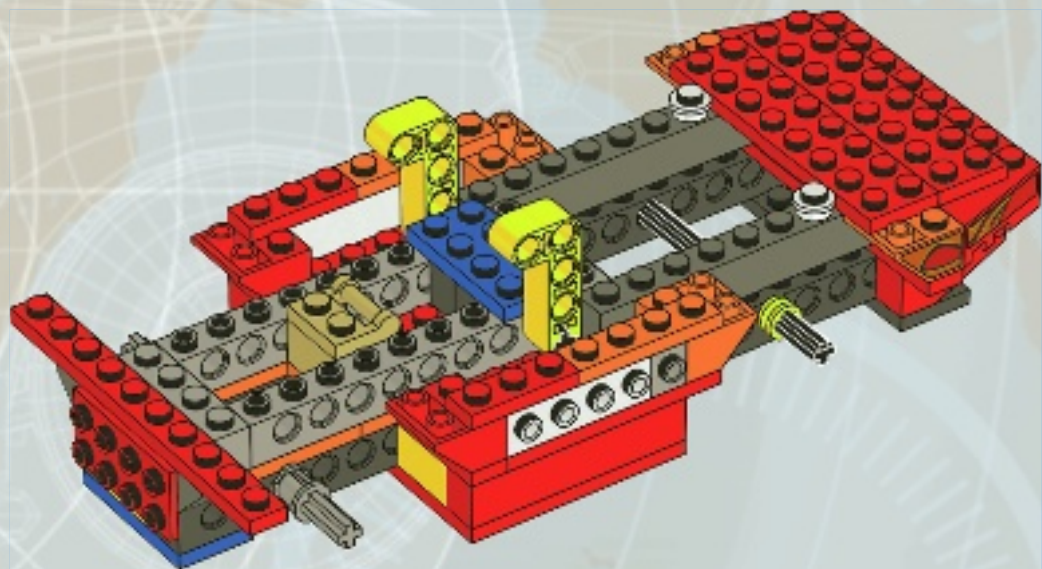



2x



2x

24

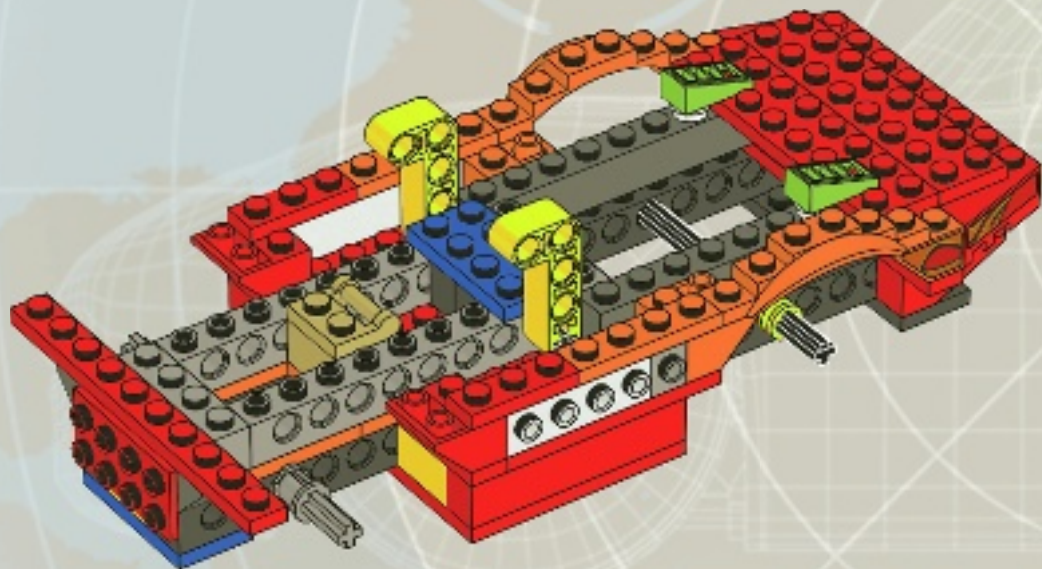



25

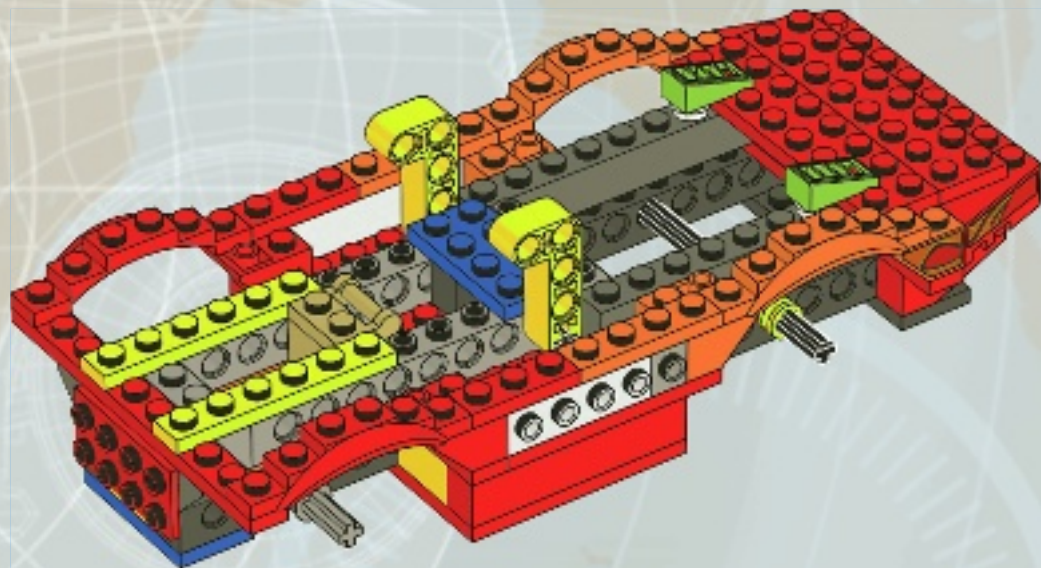

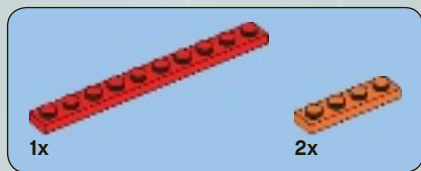

26

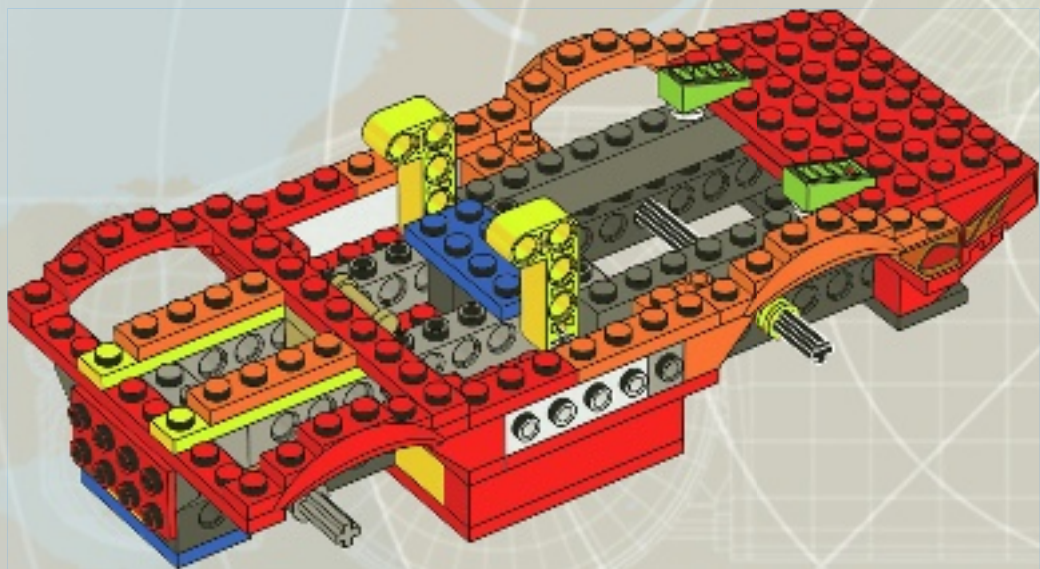

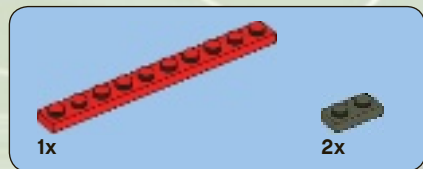

27

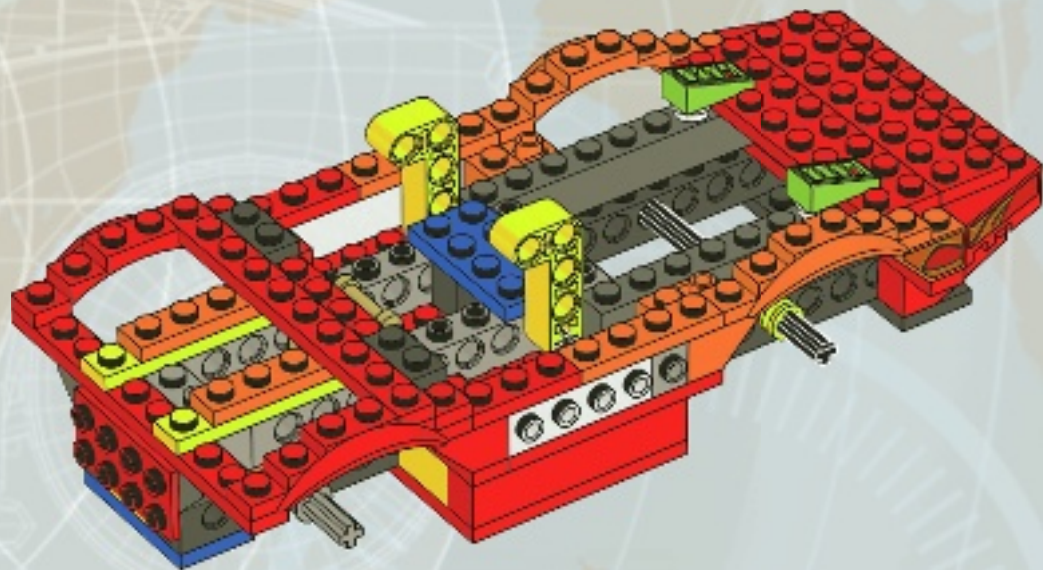

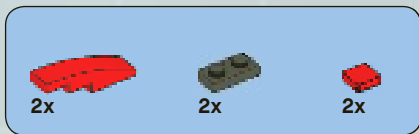
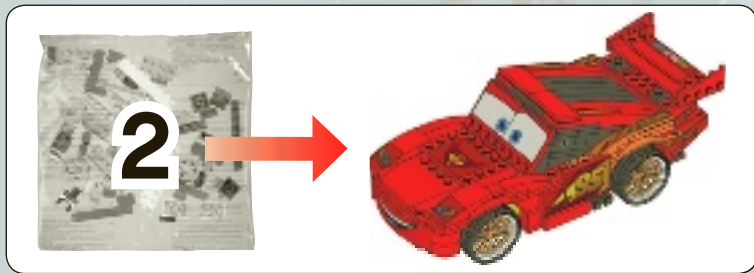

28

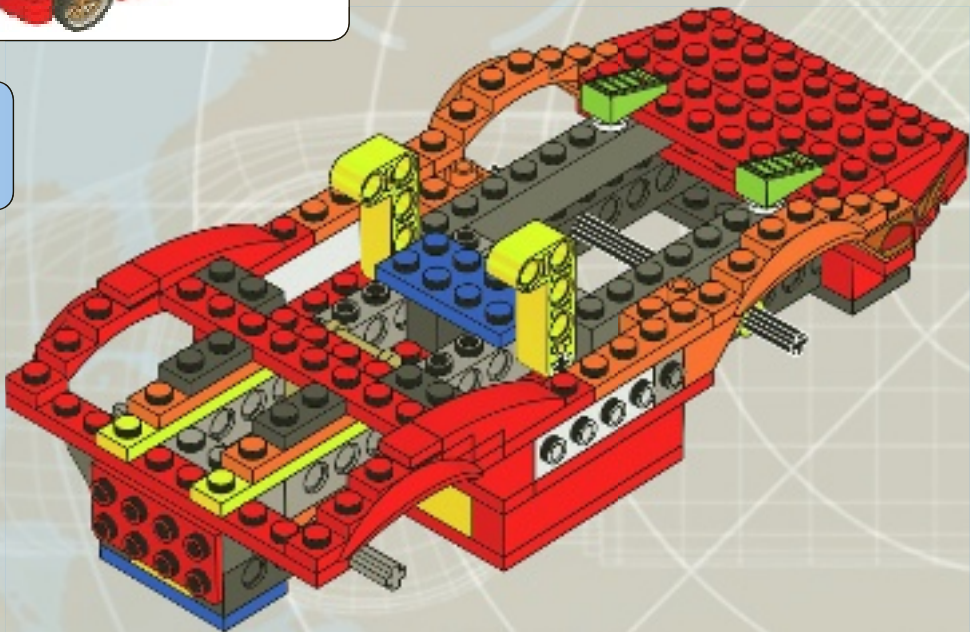



2x

29

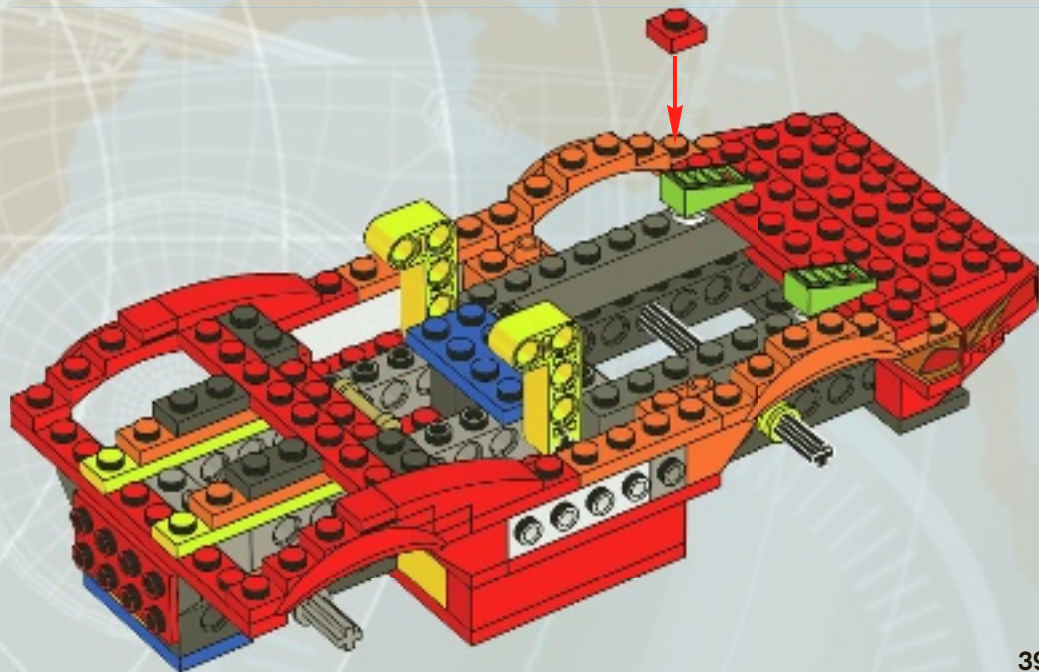



2x



2x

30

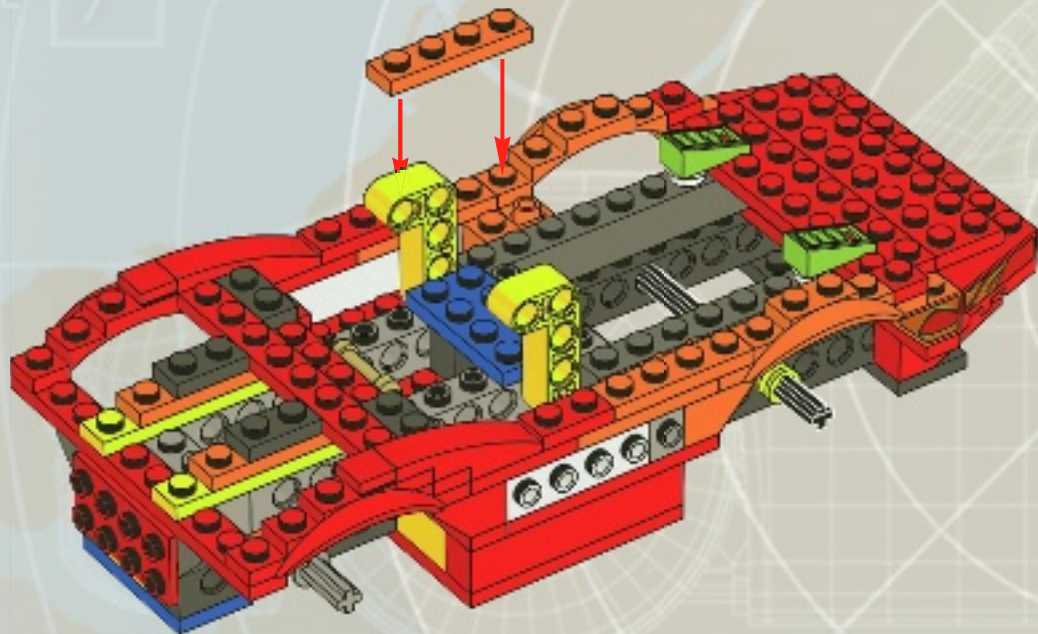



31

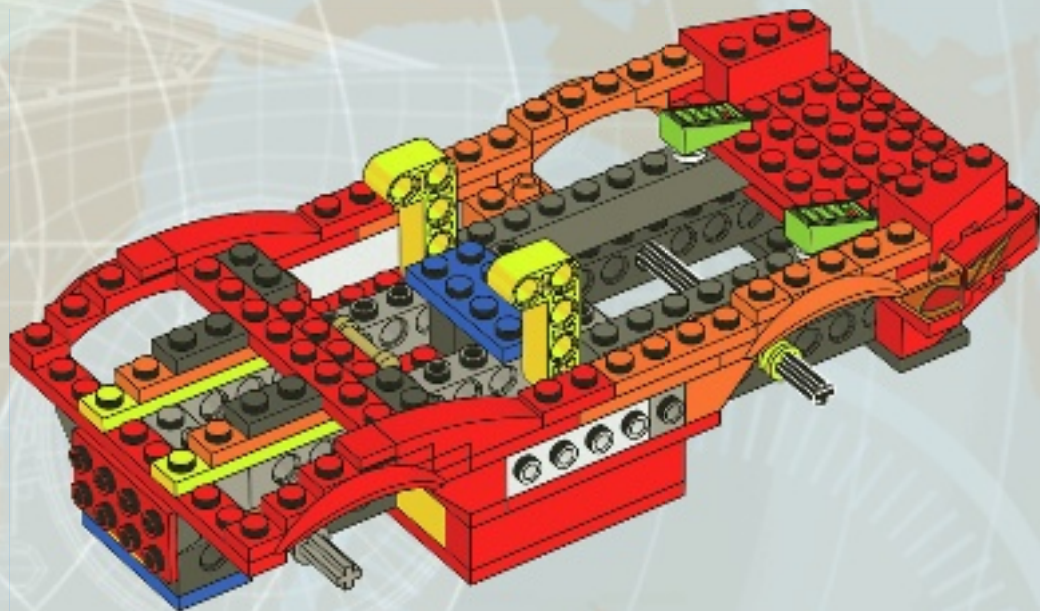

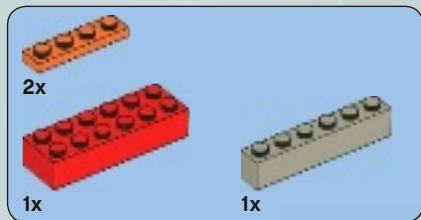

32

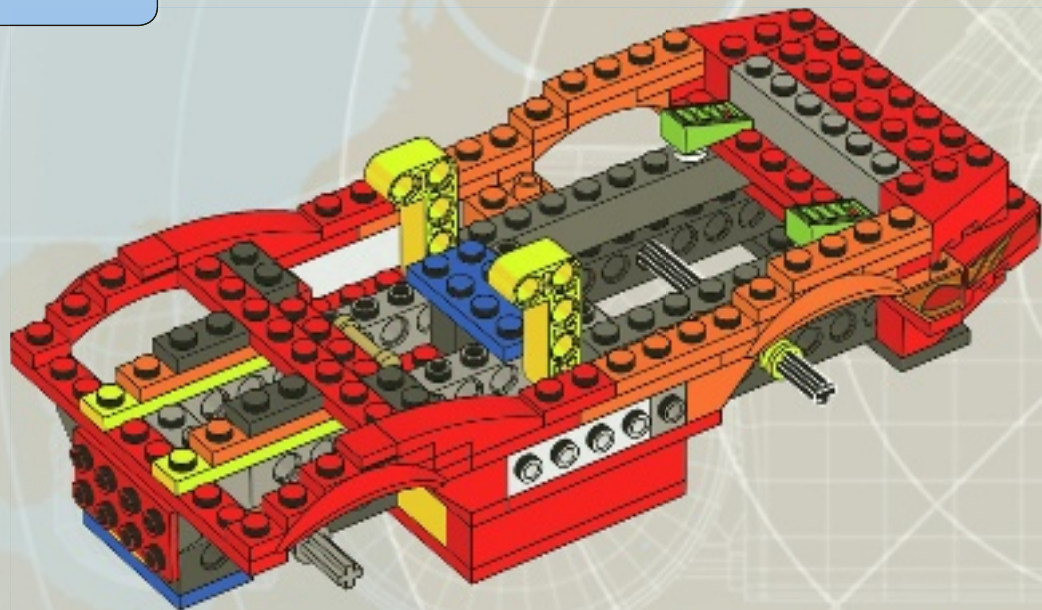

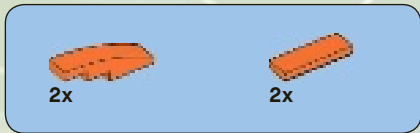

33

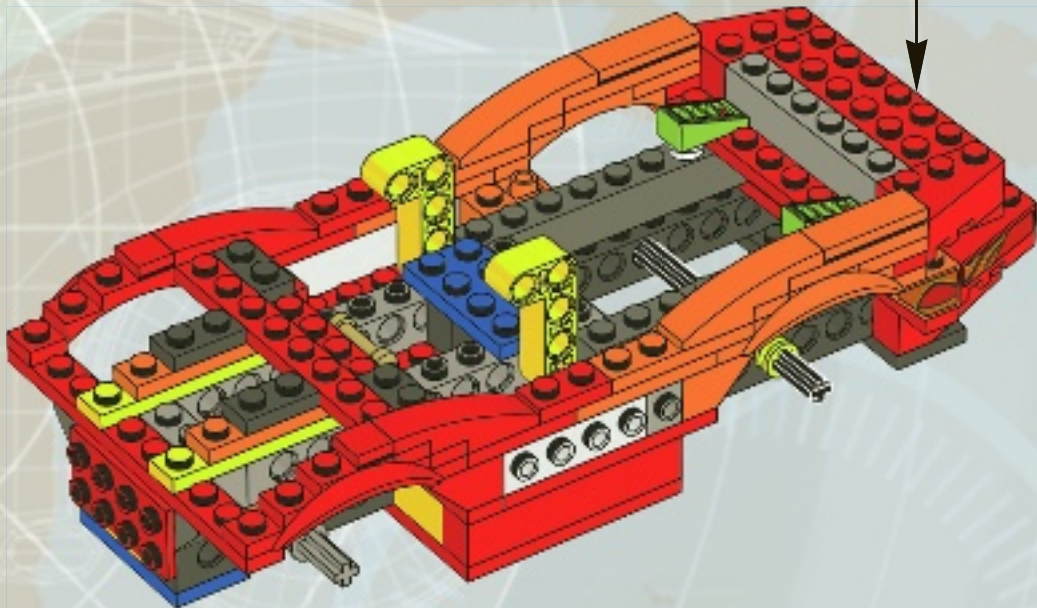



2x



1x

34

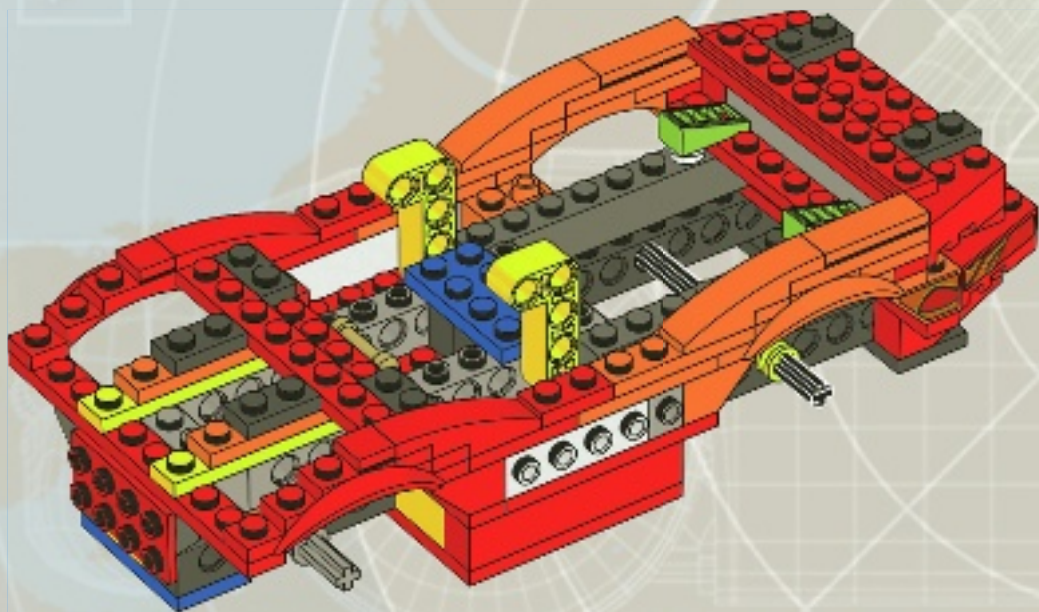



2x

35

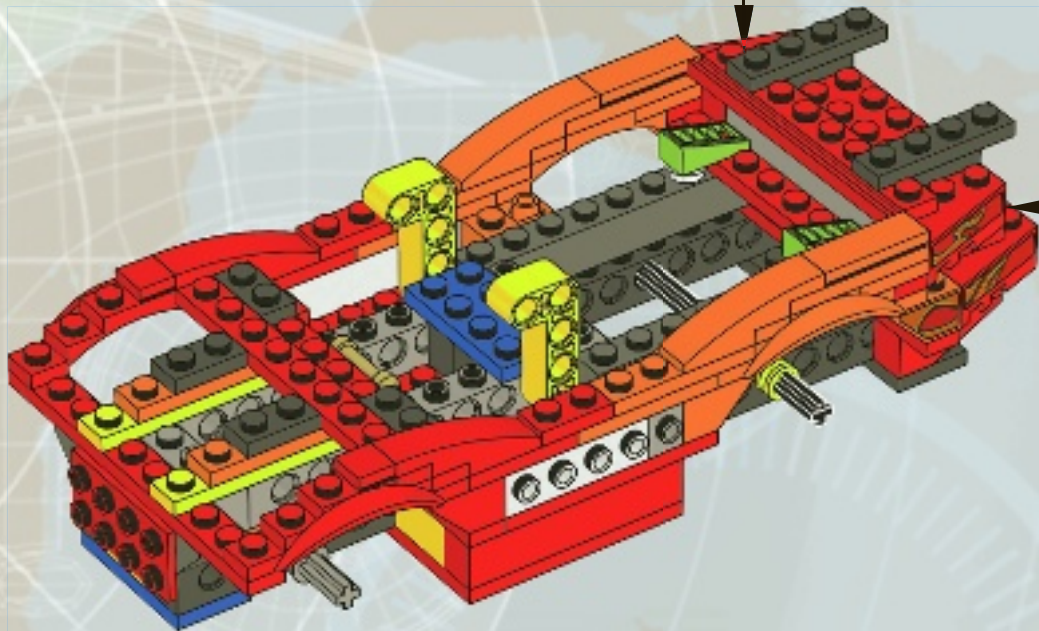

36

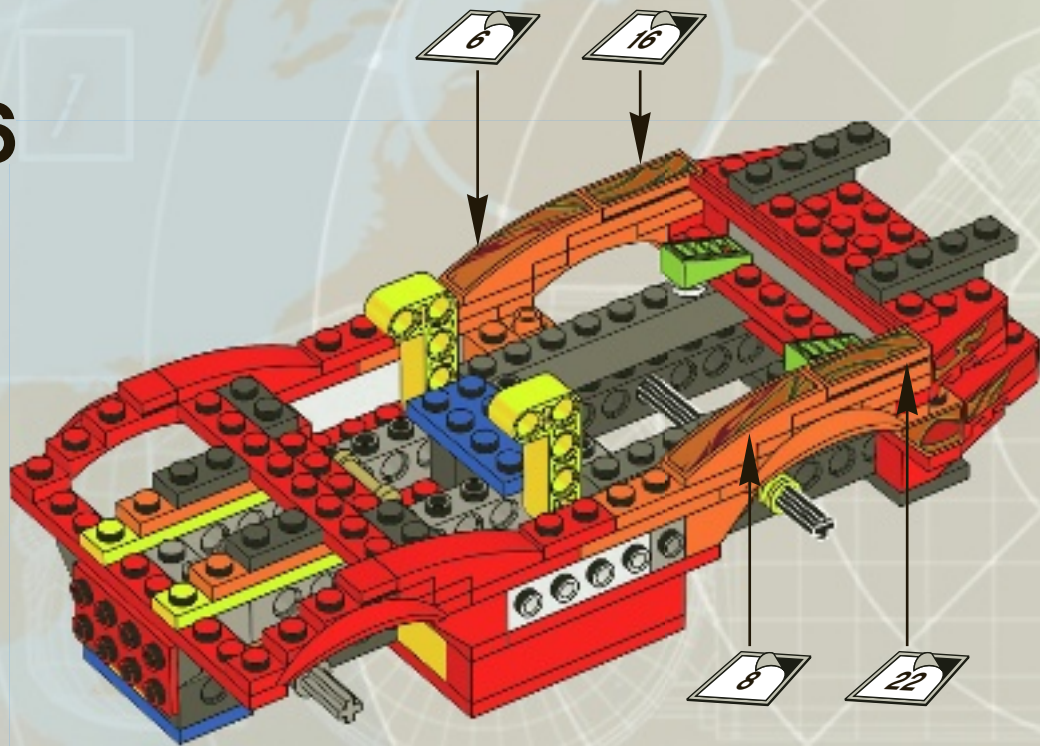

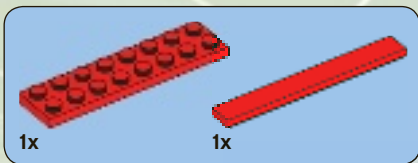

37

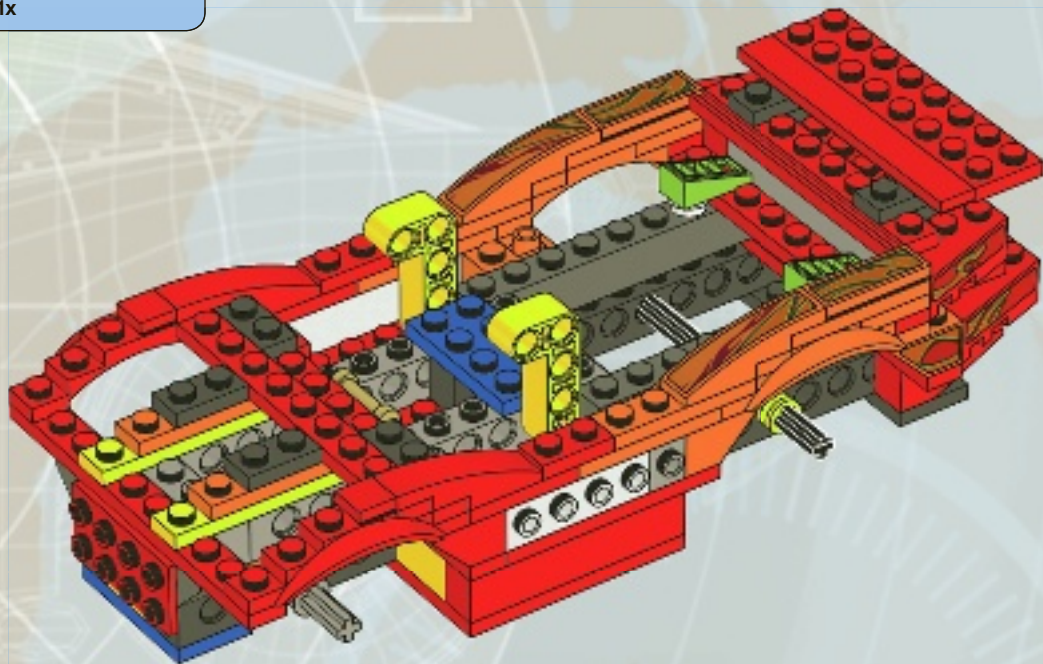



2x



2x

38

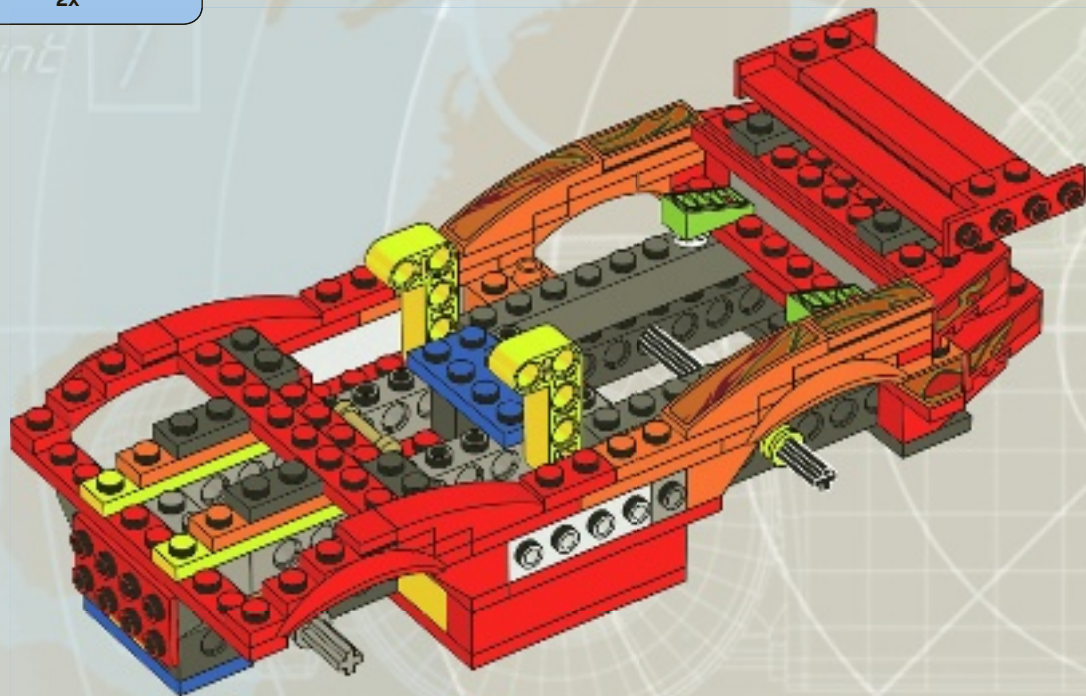



39

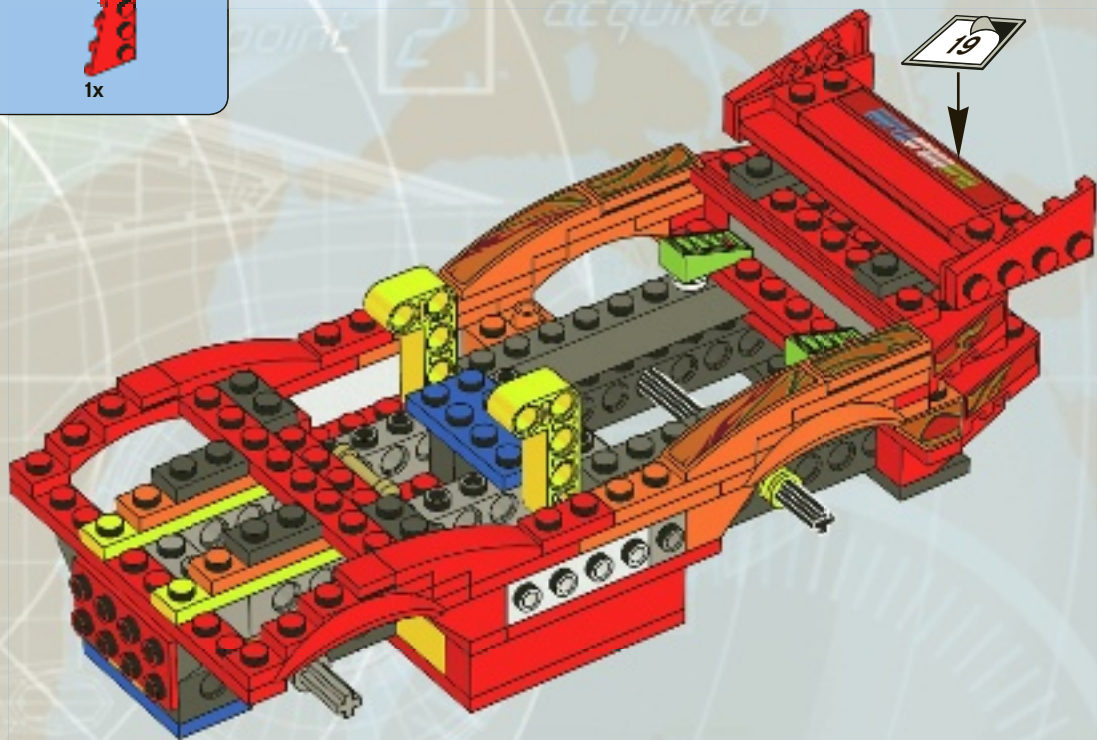

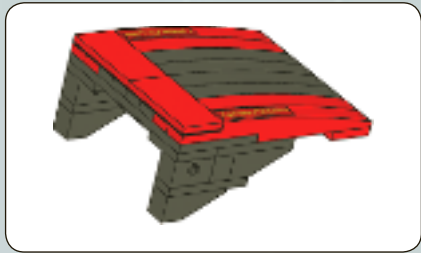

1

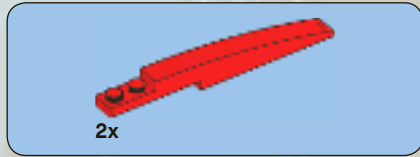

2



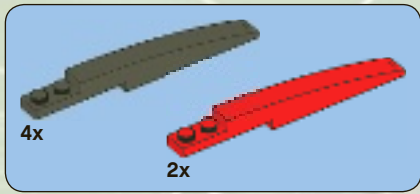

3

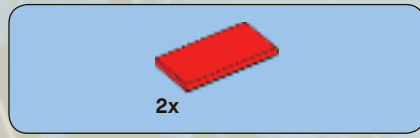
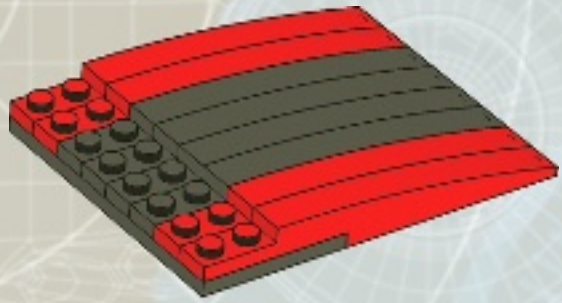

4

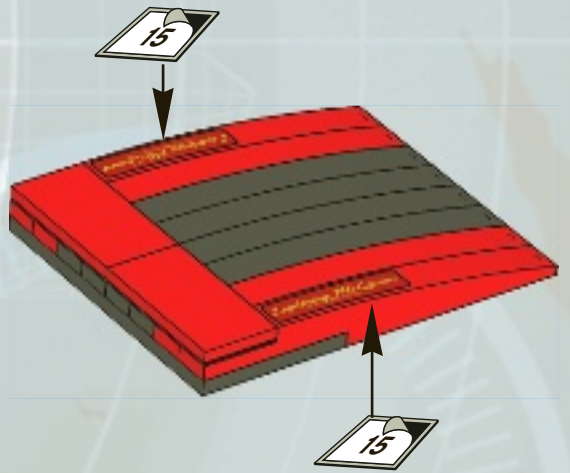

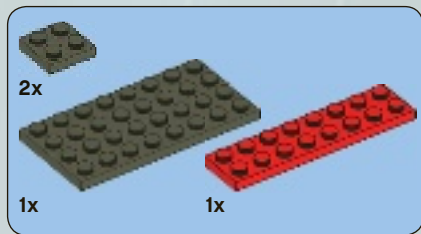

5

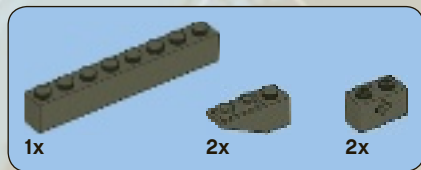
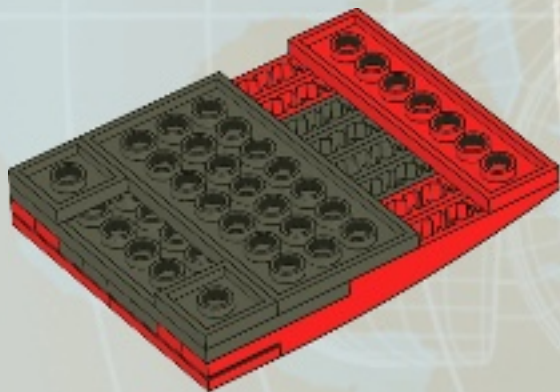

6

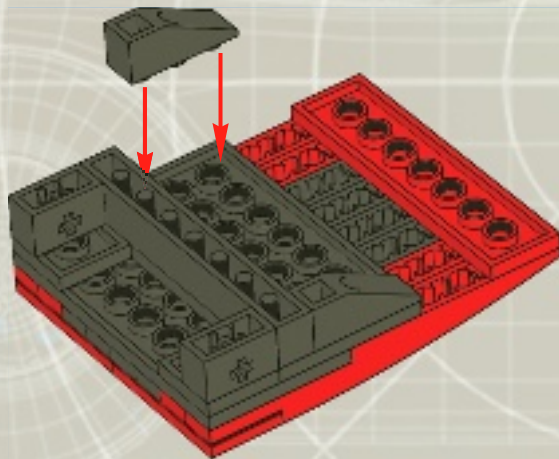



2x

7

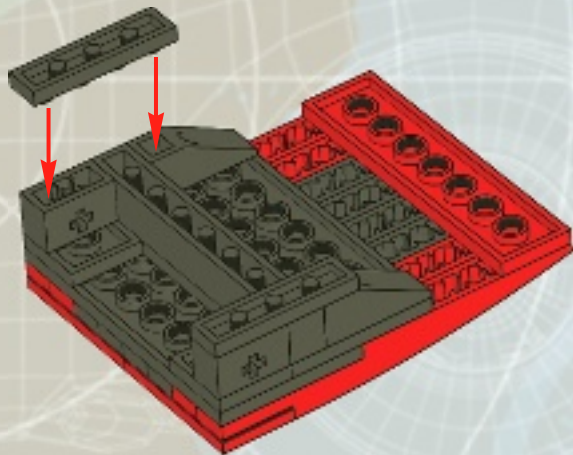

2x

8

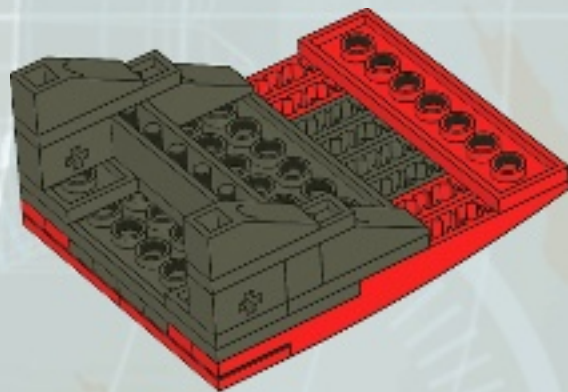

waypoint

7

40

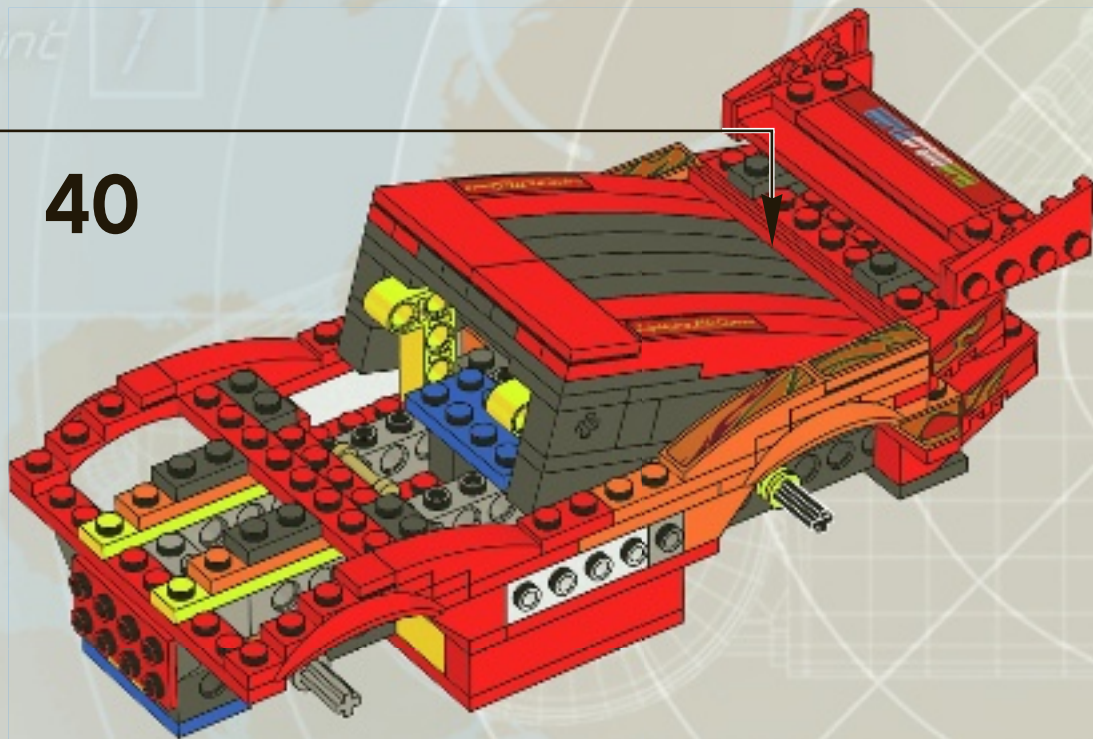



2x

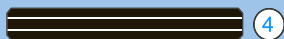

1:1

41

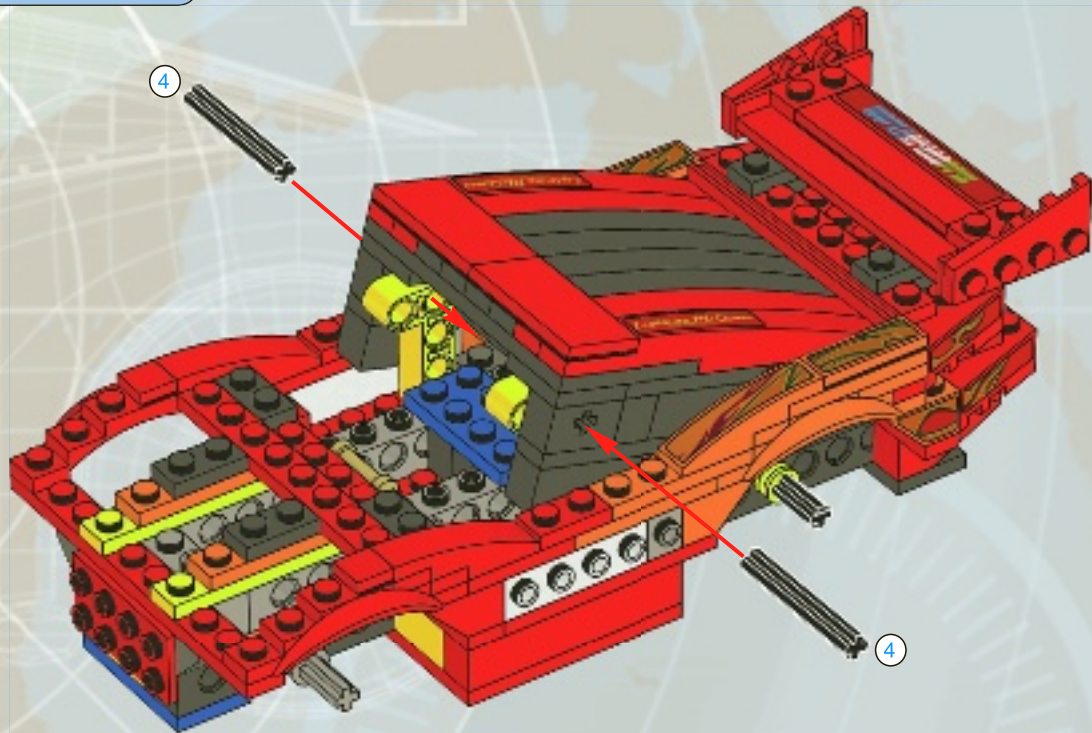

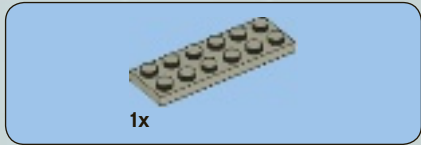
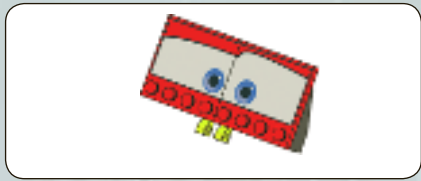

1

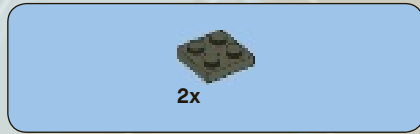

2

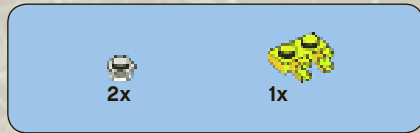

3



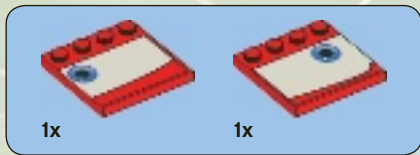

4

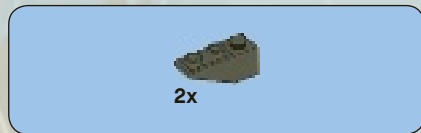
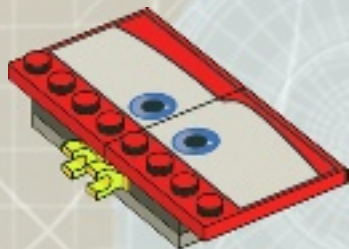

5

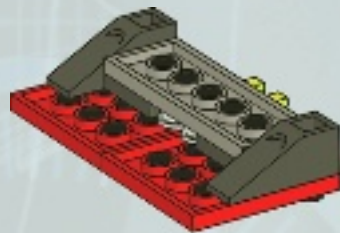
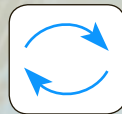

waypr **42**

7

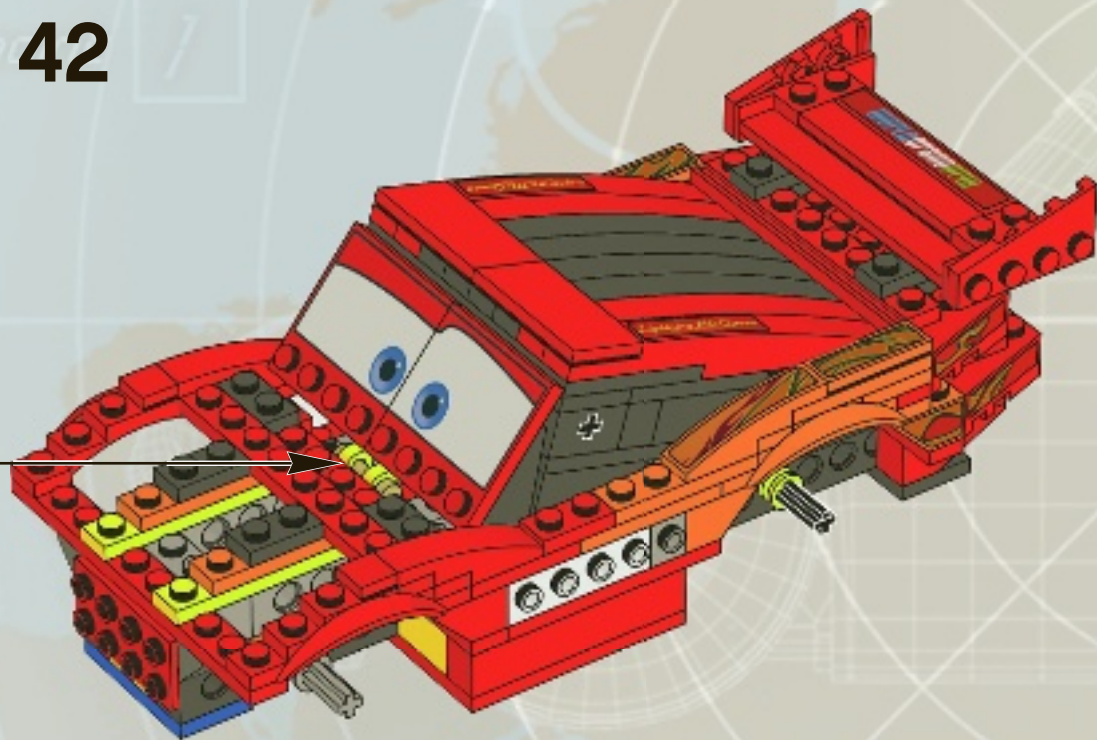



1x

43

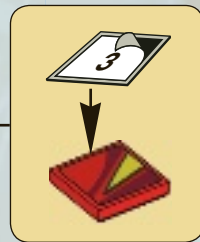
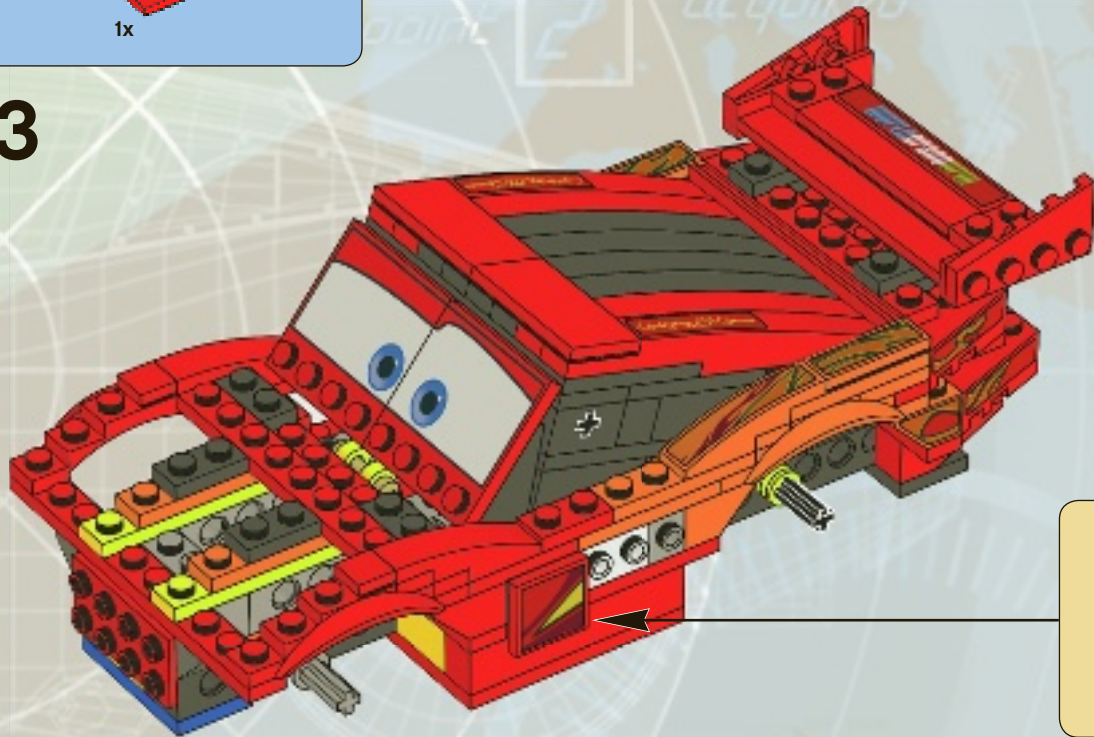

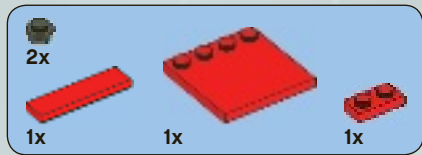

44

1



2



3



4



waypoint

2

target
acquired

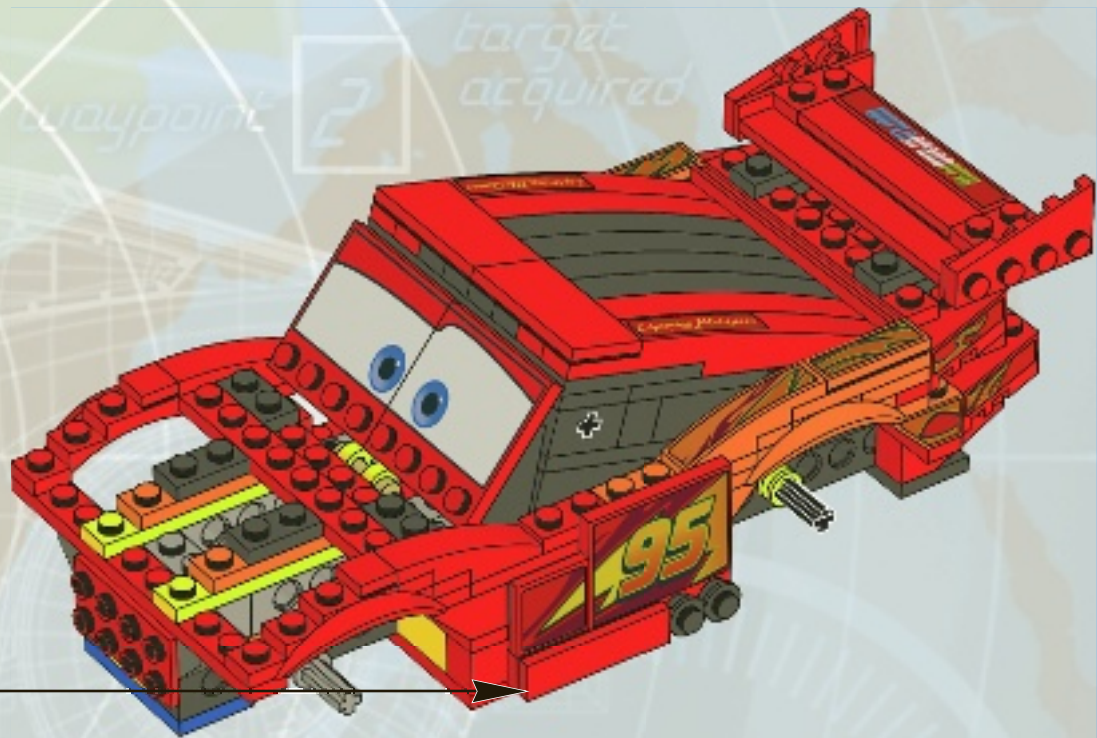



1x

45

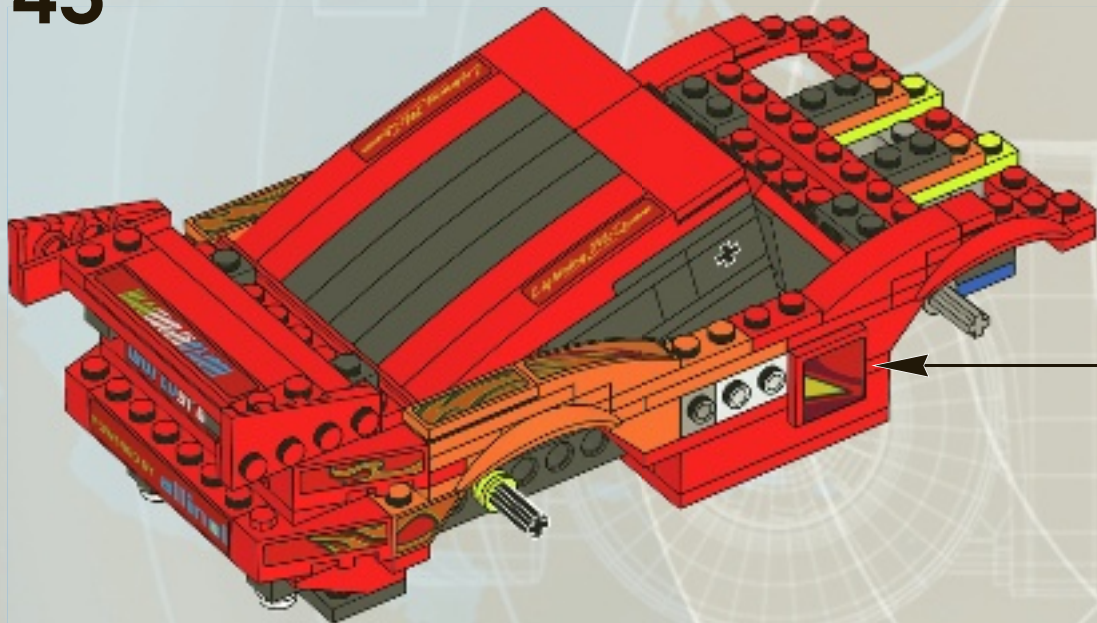

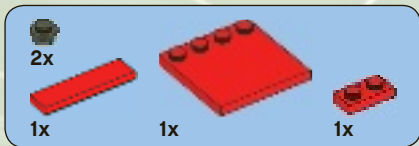

46

1



2



3



4



waypoint

7

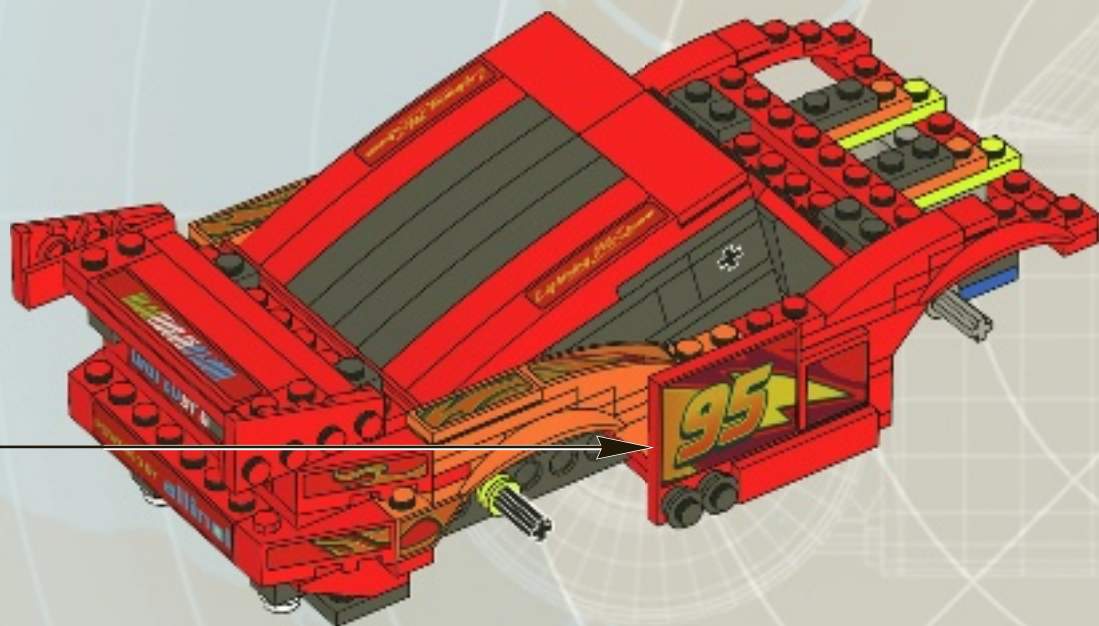

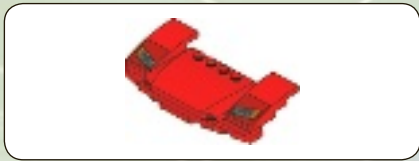

1x

1



1x

2

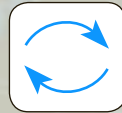

1x

1x

3

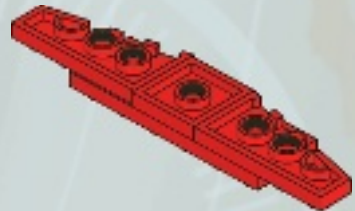



2x

4

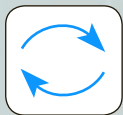

1x

5





6

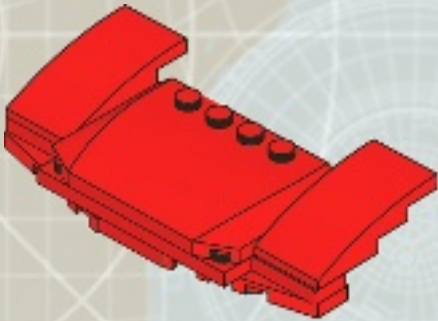

7

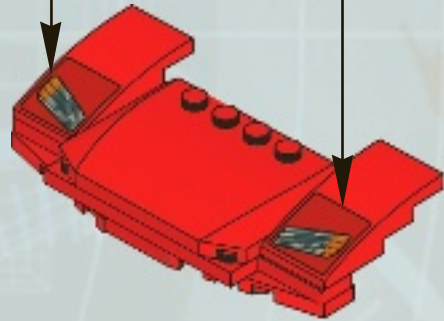



waypoint 7

47

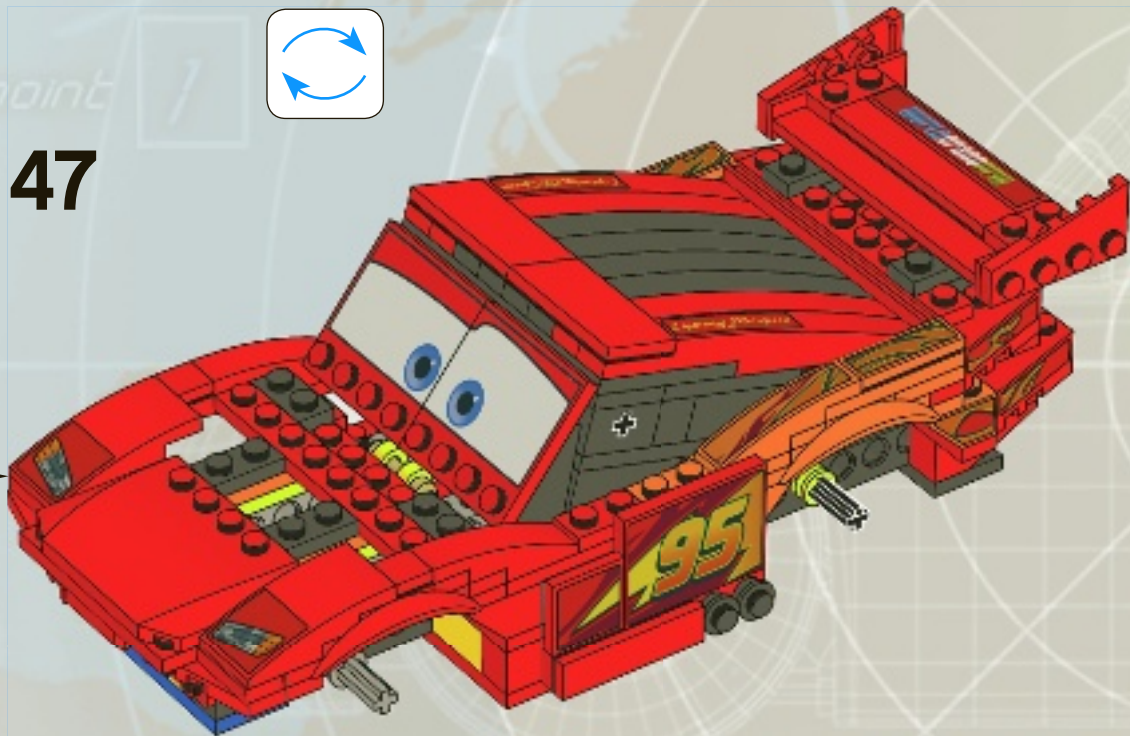

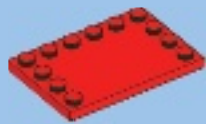

1x

48





2x

49

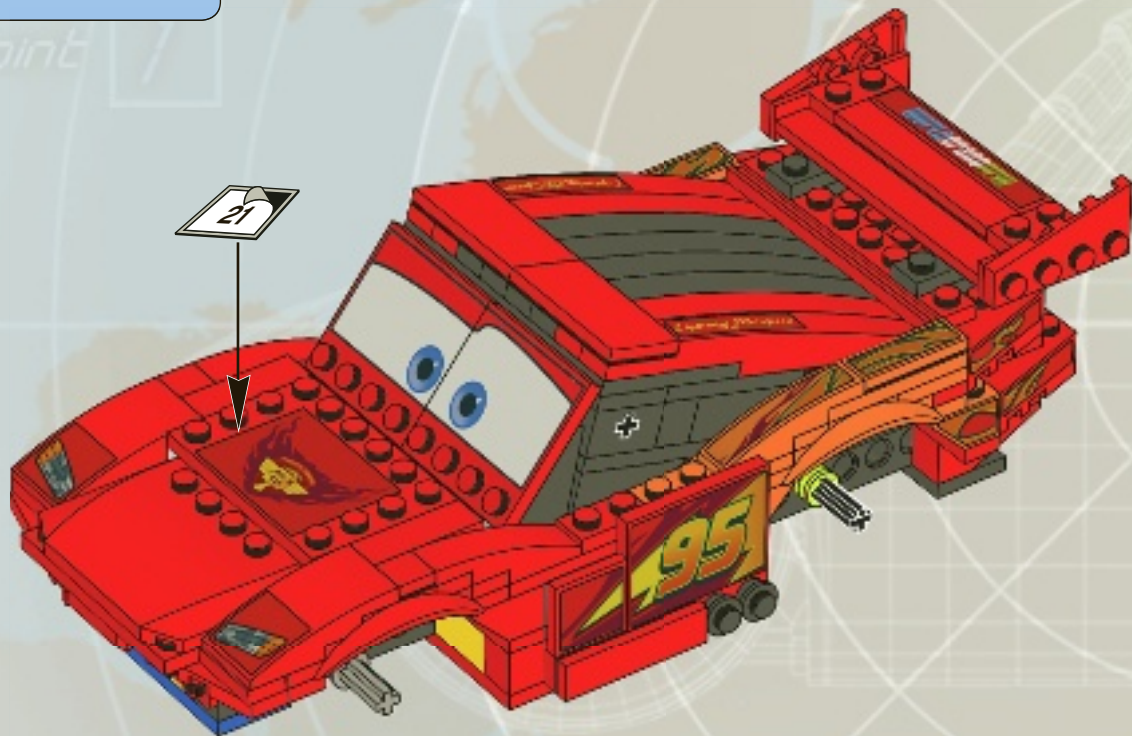

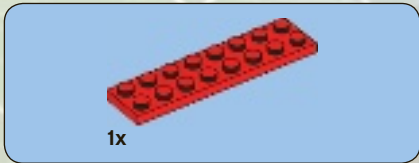

1

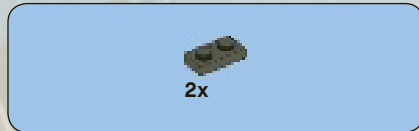

2

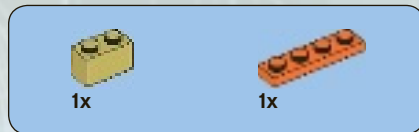
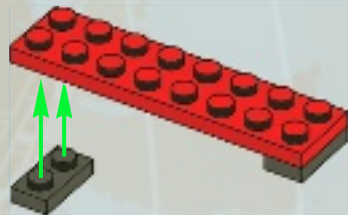

3

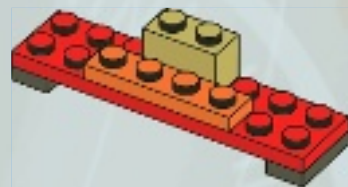



1x

4

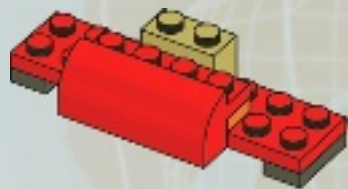

1x



2x

5

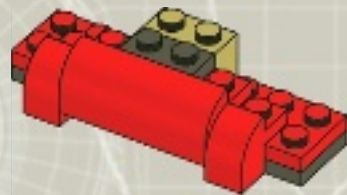



4x

6

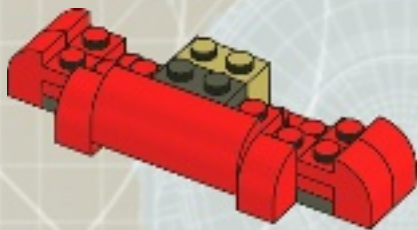

1x



1x

7

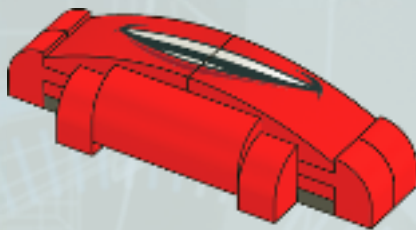

50

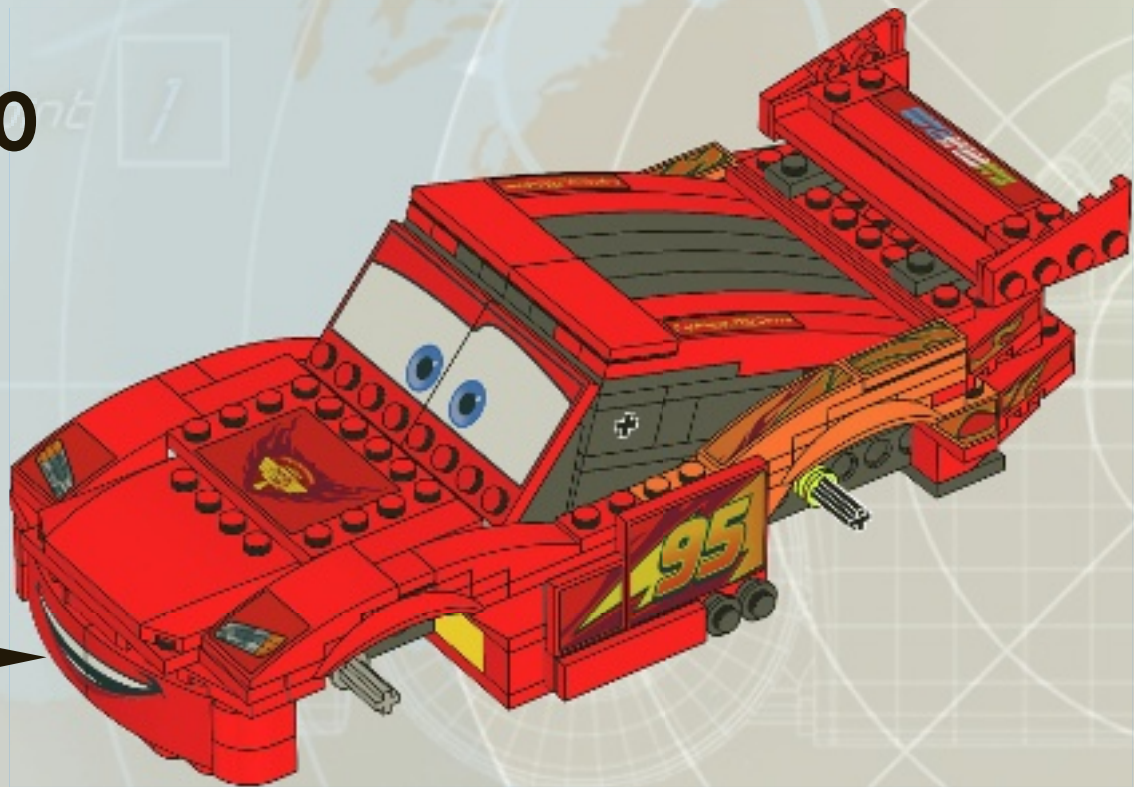



51

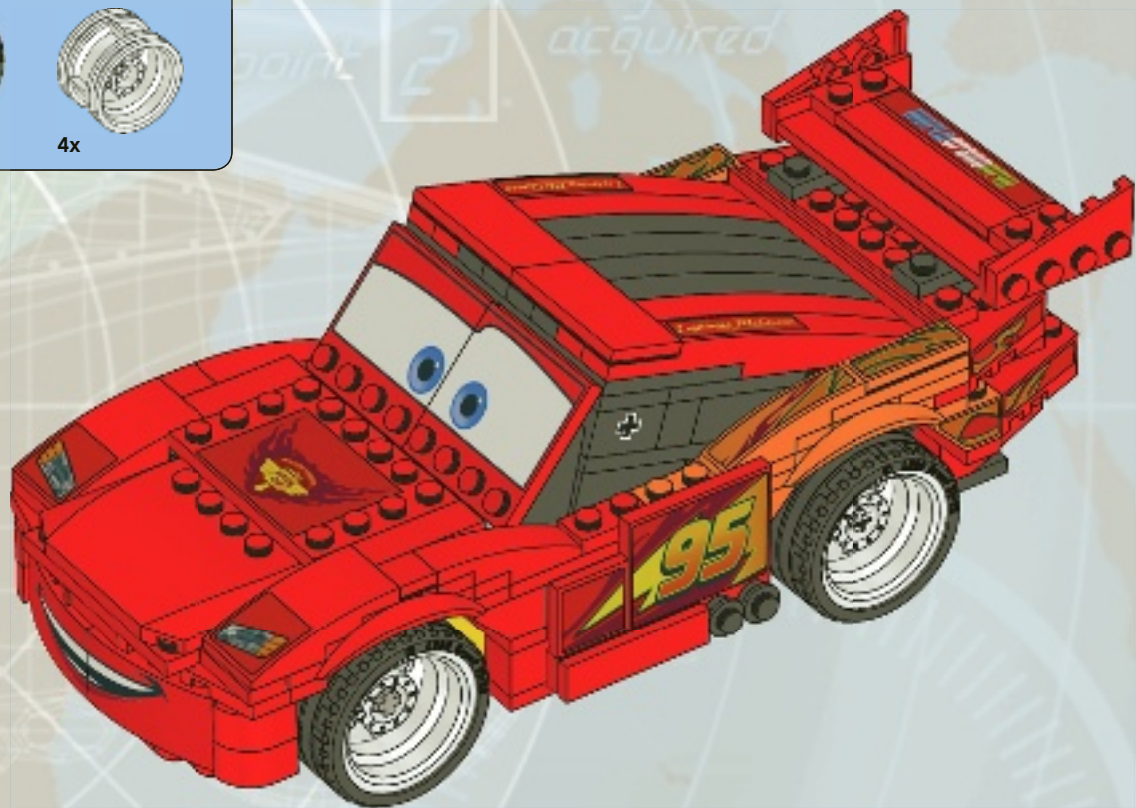



4x

52

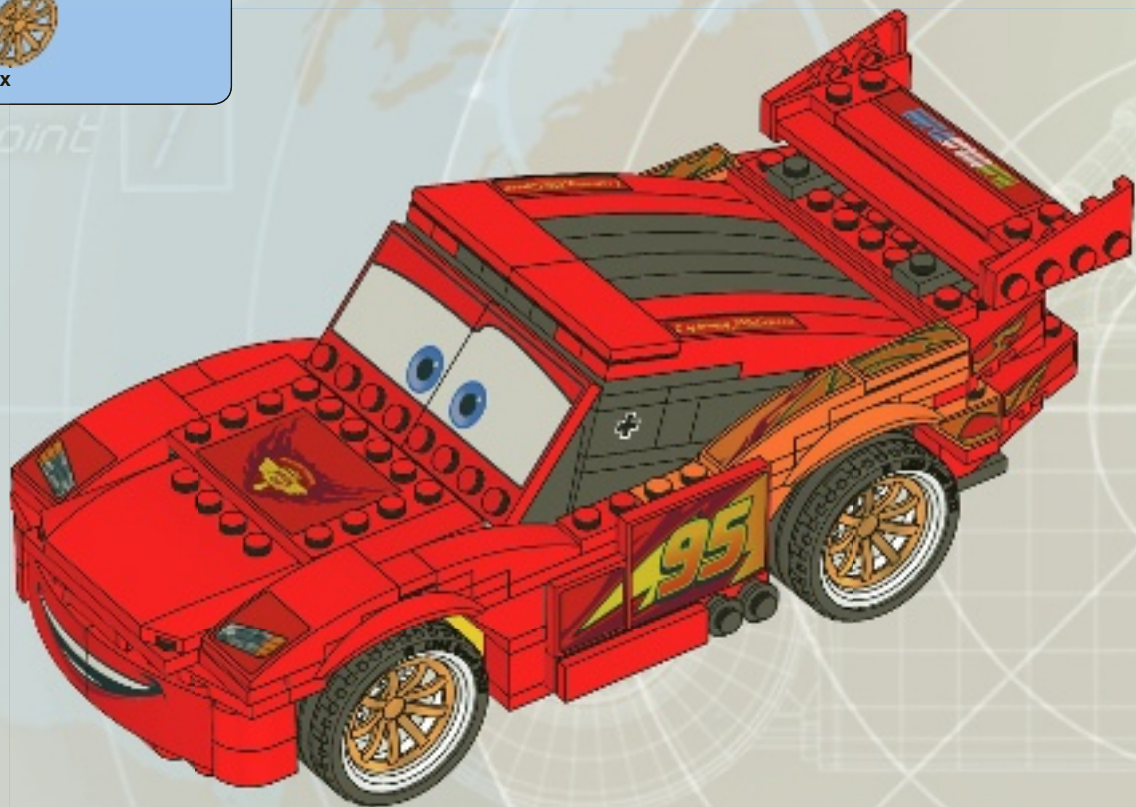

53



waypoint

2

target
acquired



2x
4143254



8x
614101



4x
4624514



2x
4109995



1x
4217562



2x
300921



2x
4181138



2x
4526929



2x
4527765



2x
366021



2x
428721



6x
609121



2x
4520782



1x
4116617



1x
4616348



1x
4616354



2x
4613174



4x
4571075



2x
307021



2x
302421



4x
302321



1x
302221



2x
306821



2x
242021



2x
362321



2x
4533742



2x
243121



2x
4560179



2x
4113858



2x
4616342



1x
4624538



1x
4620704



1x
379521



1x
416221



1x
4624534



2x
303221



6x
303421



5x
447721



1x
4506961



1x
4616800



2x
4282742



1x
4616360



2x
4161329



2x
4160866



1x
4617399



2x
4525791



1x
4259903



1x
306823



2x
302023



1x
300324



2x
300124



2x
366624



1x
4556156



2x
4141628

2x
4239601



1x
300826



4x
4233487

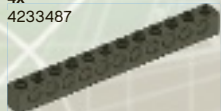

4x
389526



6x
428726



4x
4567440



9x
302326



5x
302226



4x
371026



1x
303426



2x
303526



1x
4550017



2x
4144575



4x
614126



1x
384926



2x
4246901

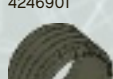

4x
4499234

2x
4121715

2x
370526

2x
370526

1x
370626

1x
370626

1x
373726

1x
4616975

1x
4616975

1x
4617006

2x
4617019

1x
4179826

4x
4179825

1x
4617013

2x
4524929

1x
4617013

2x
4524929

1x
4617013

2x
4524929

1x
4617013

2x
4524929

1x
4617013

2x
4524929

1x
4617013

2x
4524929

4

6

10

4x
4118829

2x
4523603

2x
4177932

2x
4620693

12x
4118782

2x
4621801

2x
4540385

2x
4211622

1x
4211394

1x
4211394

1x
4211393

1x
4211393

1x
4535768

2x
4211374

1x
4211395

1x
4211452

2x
4515341

1x
4211504

2x
4558953

2x
4616645

2x
4616645

2x
4616645

2x
4616645

2x
4616645

9

1x
4616969

4x
4624555

2x
4211107

2x
4211096

1x
4211043

2x
4624473

2x
4624473

2x
4624473

2x
4624473

2x
4624473

2x
4624473

2x
4624473

Customer Service
Kundenservice
Service Consommateurs
Servicio Al Consumidor

www.lego.com/service or dial

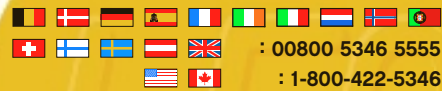

: 00800 5346 5555

: 1-800-422-5346



8426



8486



8487





LEGO.com/CARS



www.LEGOclub.com



LEGO Club Email



LEGO Club Magazine

LEGO club™

FREE! GRATIS! GRATUIT!

SIGN UP ONLINE!

www.LEGOclub.com



00800 5346 5555*



1-866-534-6258 • 1-877-518-5346

US & Canada only

Outside continental

- * Freephone. Mobile charges may apply.
- * Numéro sans frais. Des frais peuvent s'appliquer avec les téléphones cellulaires.
- * Gebührenfrei, Kosten für Anrufe aus Mobilfunknetzen können abweichen.
- * Gratis telefonnummer vanaf vaste lijn.
- * Det er et gratis nummer, når du ringer fra fasttelefon.
- * Det är gratis, när du ringer från en fast telefon.
- * Numéro sans frais. Des frais peuvent s'appliquer avec les téléphones portables.



WIN!

Go to www.LEGOsurvey.com/product to fill out a survey for a chance to win a cool LEGO® Product.

No purchase necessary.

Open to all residents where not prohibited.



www.LEGOsurvey.com/product

GEWINNE!

Nimm an der Umfrage auf www.LEGOsurvey.com/product teil und hab die Chance ein cooles LEGO® Produkt zu gewinnen!

Die Teilnahme am Gewinnspiel führt zu keinerlei Kaufverpflichtungen. Teilnahme in allen nicht ausgeschlossenen Ländern möglich.

WIN!

Ga naar www.LEGOsurvey.com/product, vul een enquêteformulier in en maak kans op een cool LEGO® product.

Geen aankoopverplichting, iedereen mag deelnemen, uitgezonderd ingezetenden van landen waar een enquêteverbod geldt.

GAGNE!

Visite www.LEGOsurvey.com/product pour répondre à un questionnaire et avoir une chance de gagner un produit LEGO® très cool!

Aucune obligation d'achat. Ouvert à tous les résidents des pays autorisés.

当てよう!

www.LEGOsurvey.com/product にアクセスして、アンケートにご記入ください。当選者にはレゴ®製品を差し上げます。

お買い上げの必要はありません。禁止されていない限り、すべての皆様にご利用いただけます。