

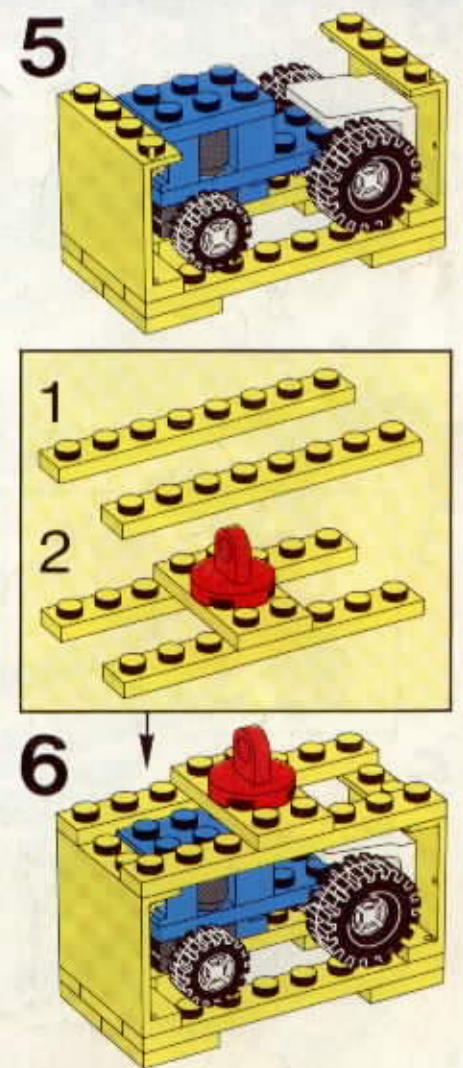

120173

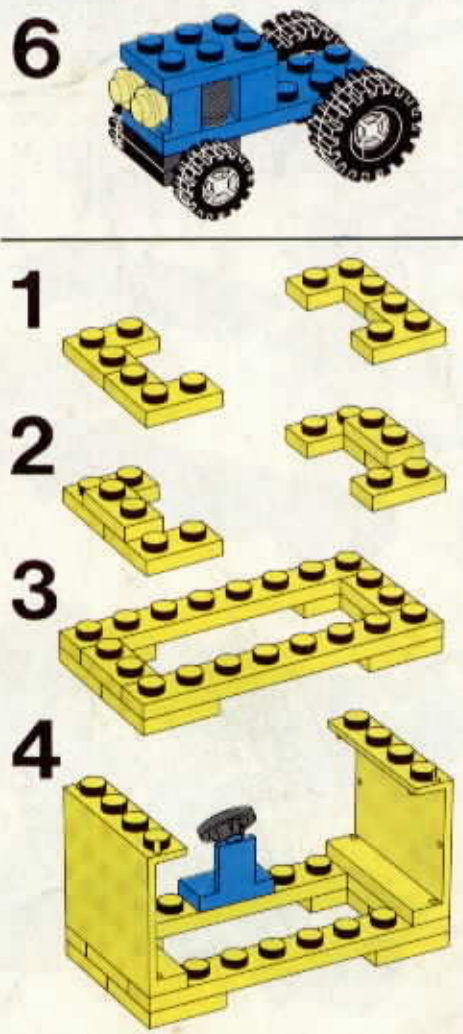

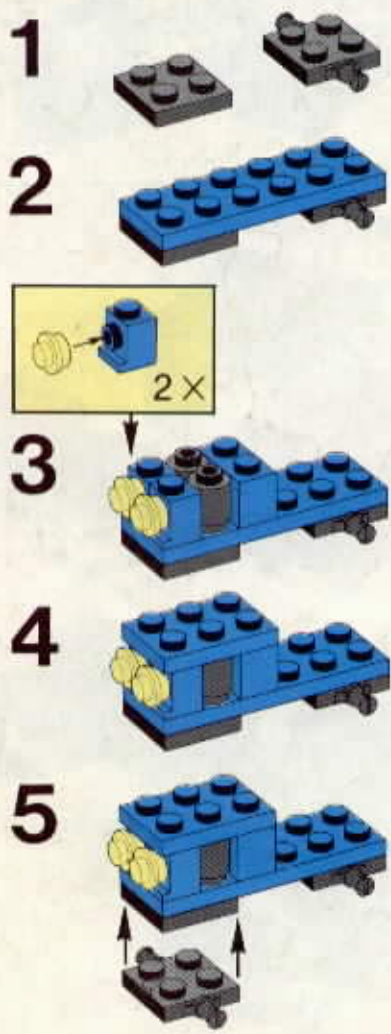

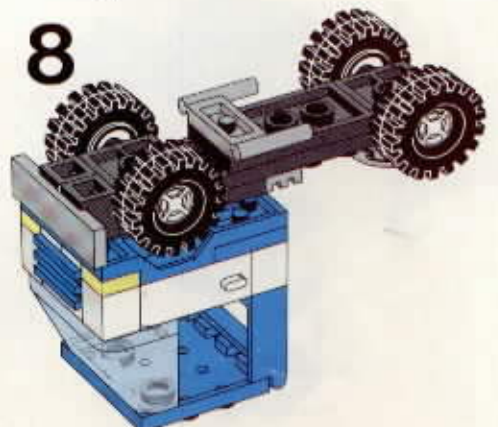
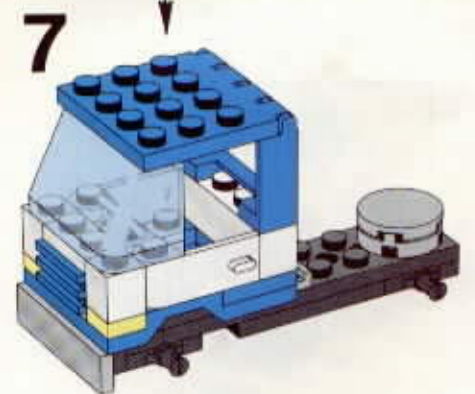
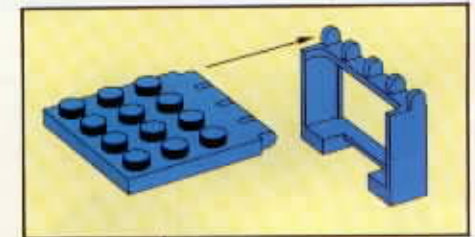
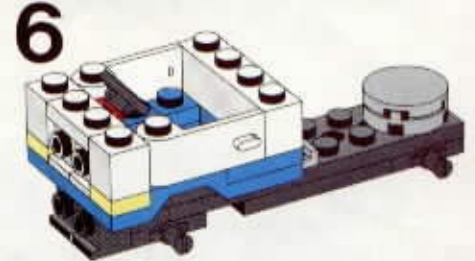
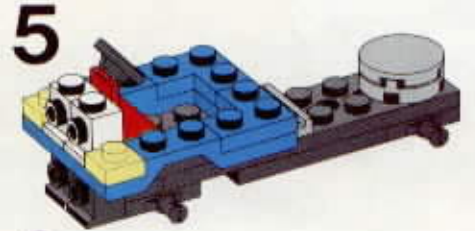
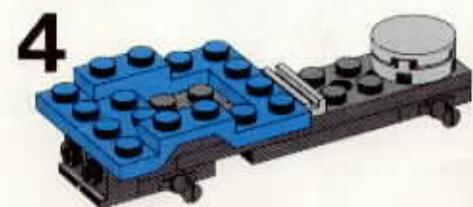
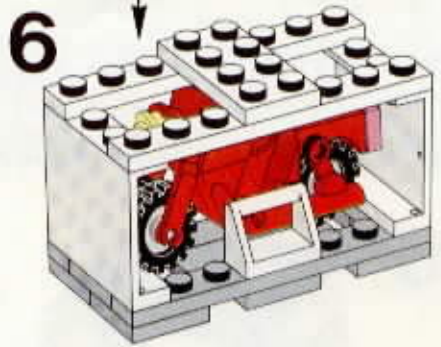
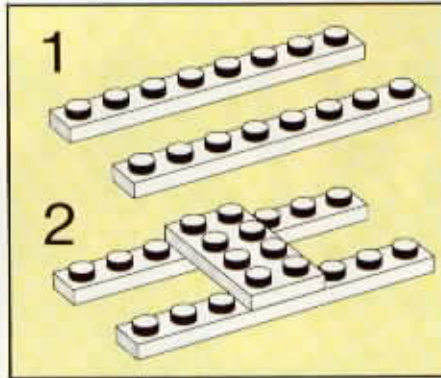
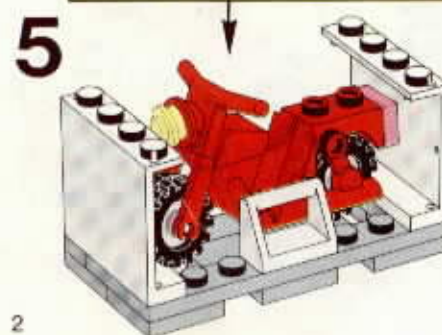
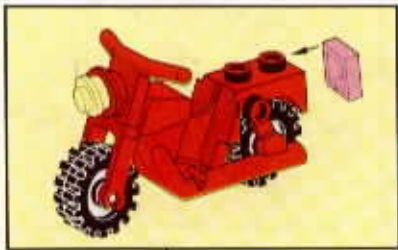
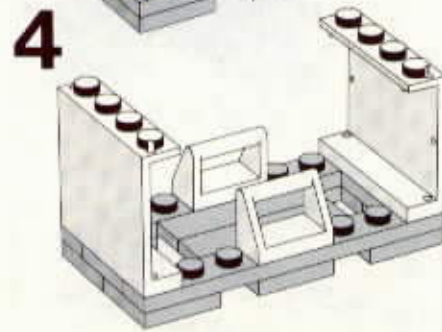
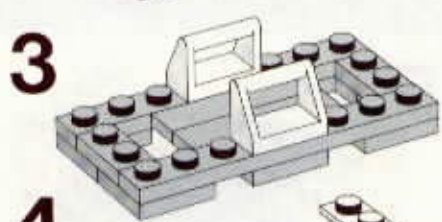
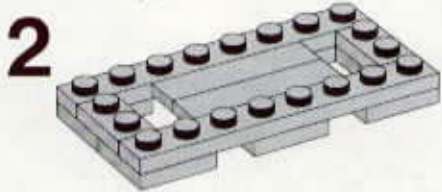
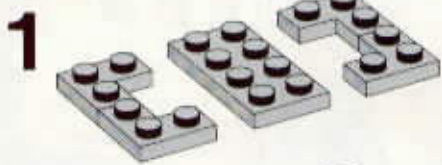
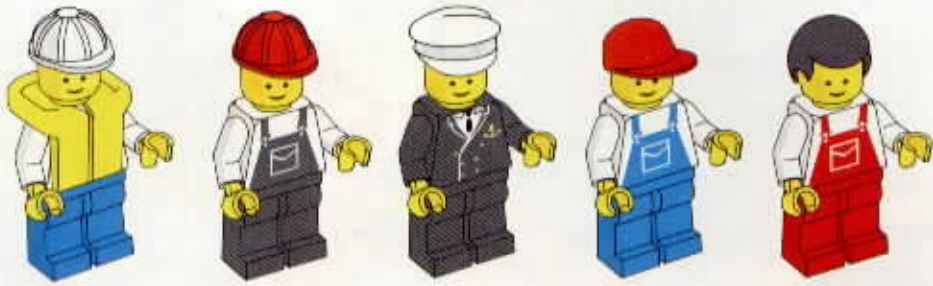
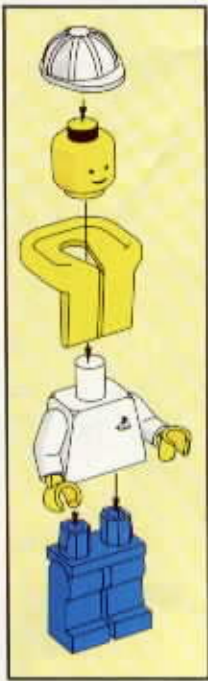
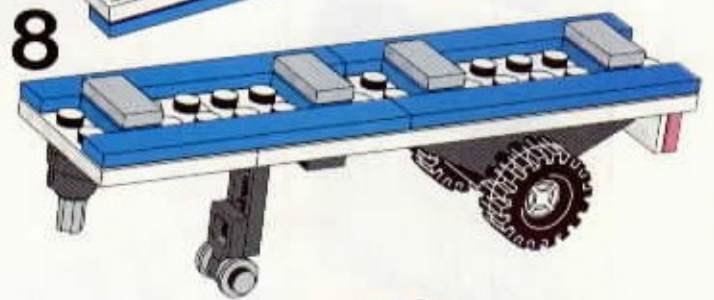
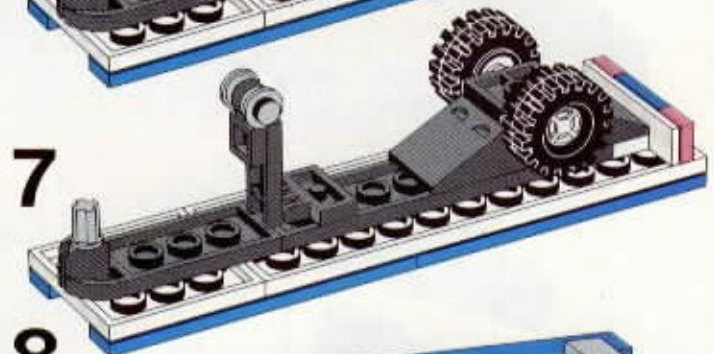
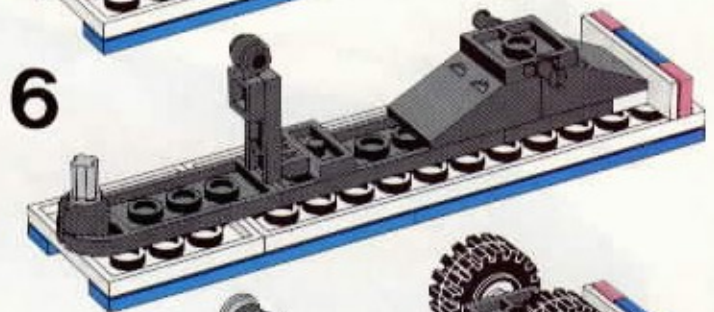
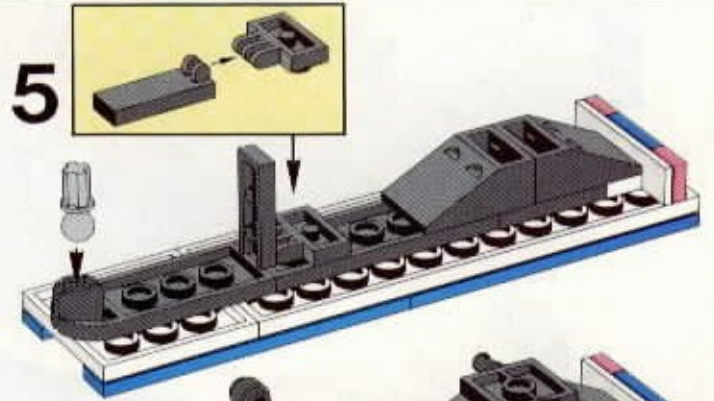
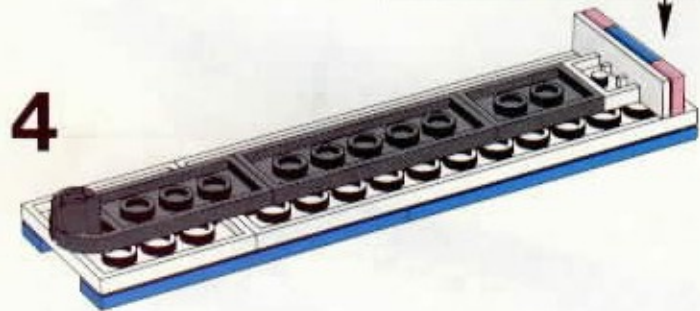
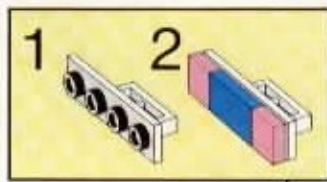
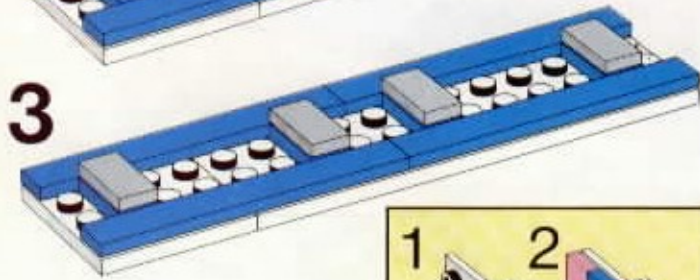
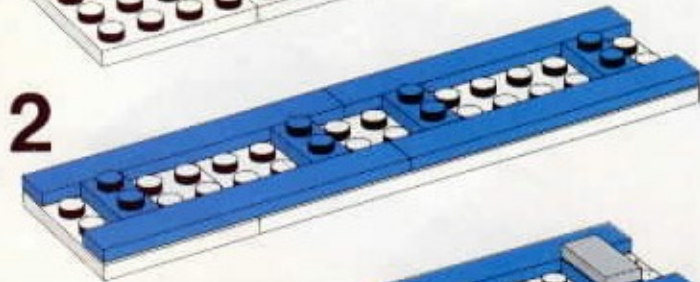

1

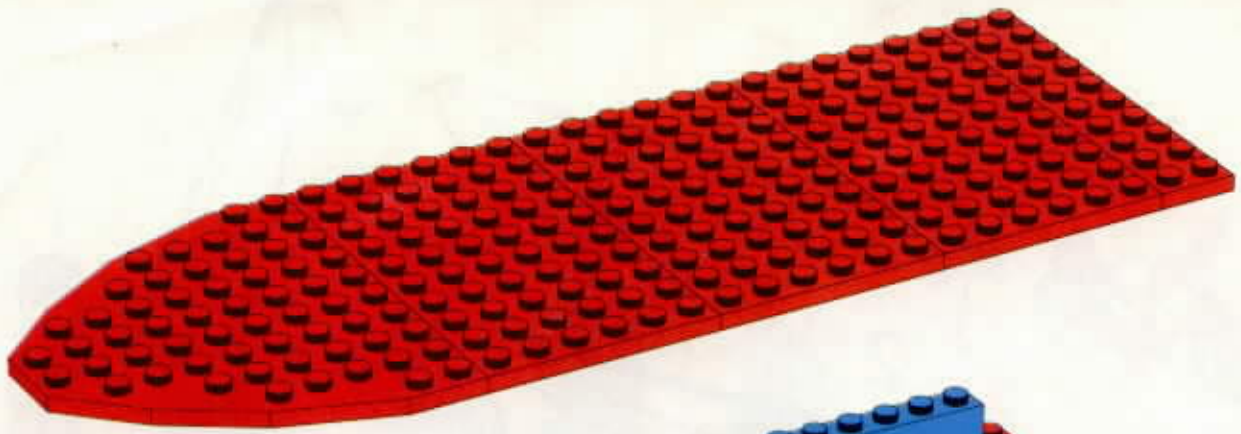

2

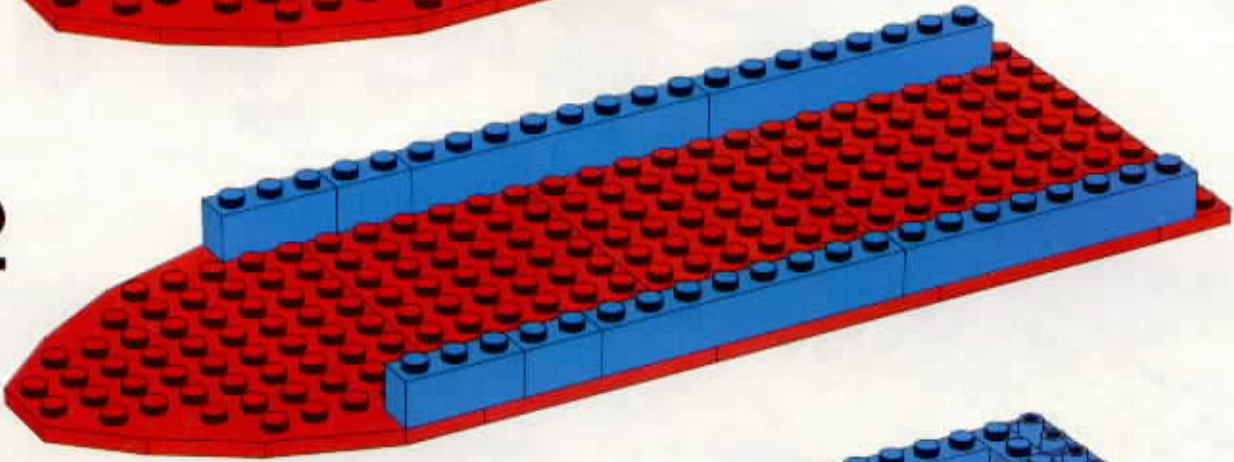

3

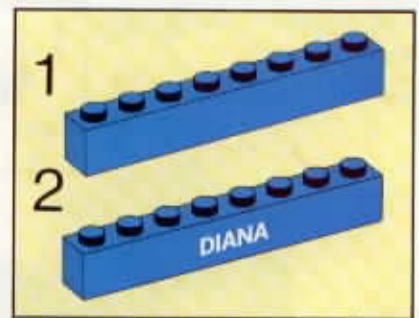
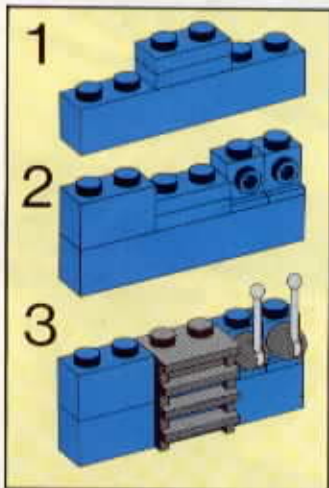
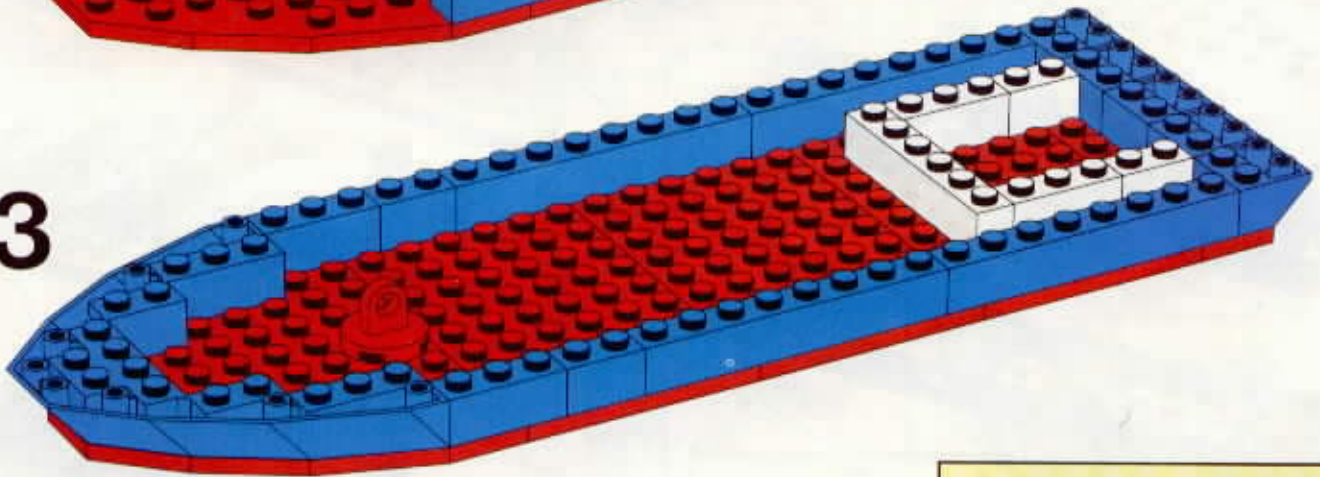

4

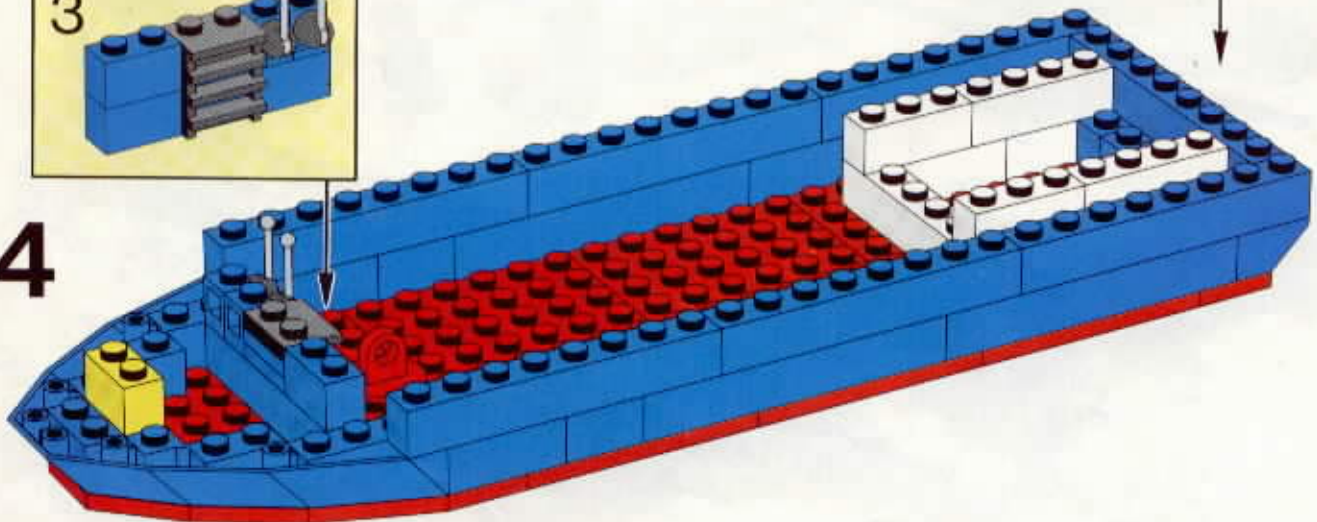

5

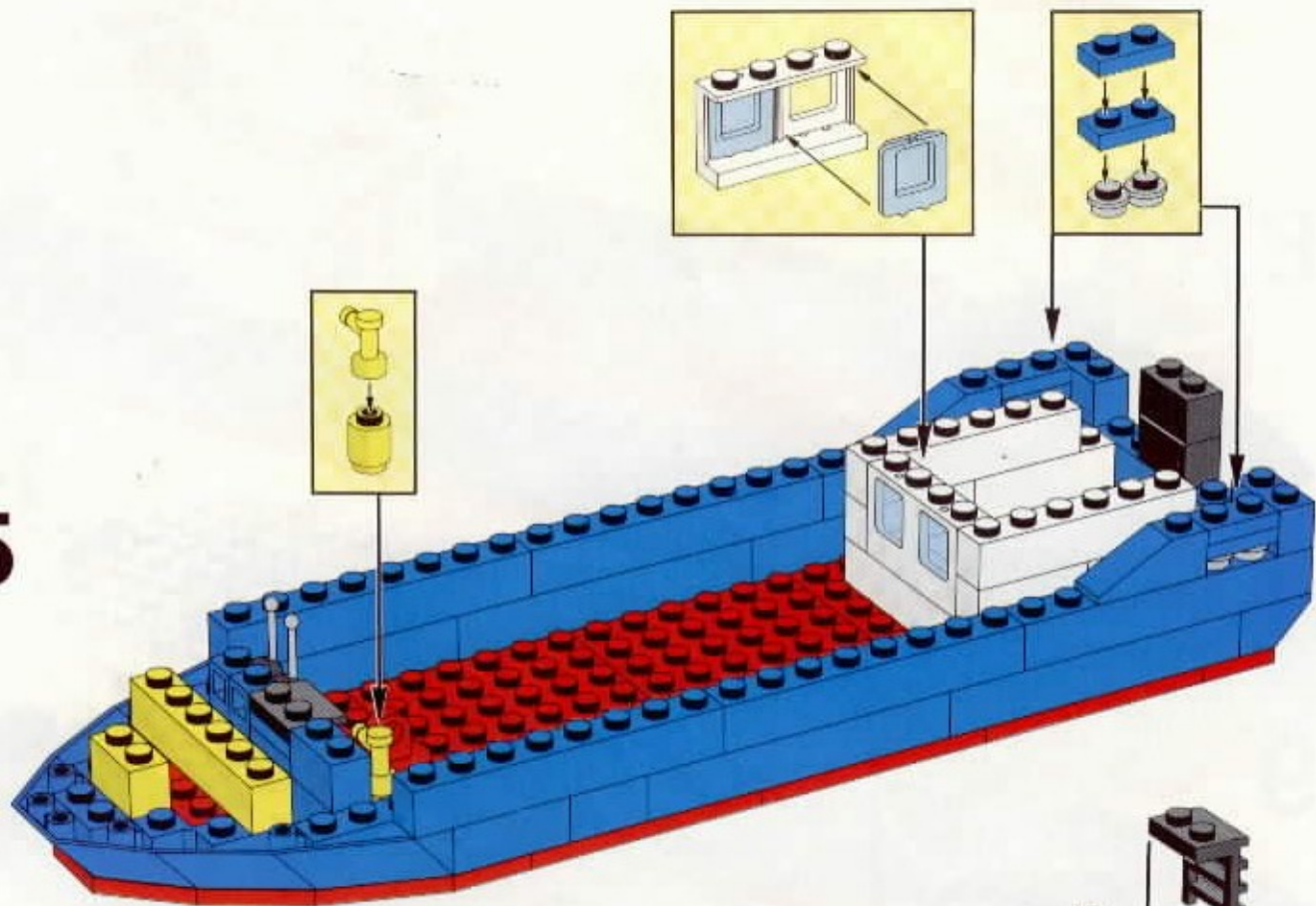

6

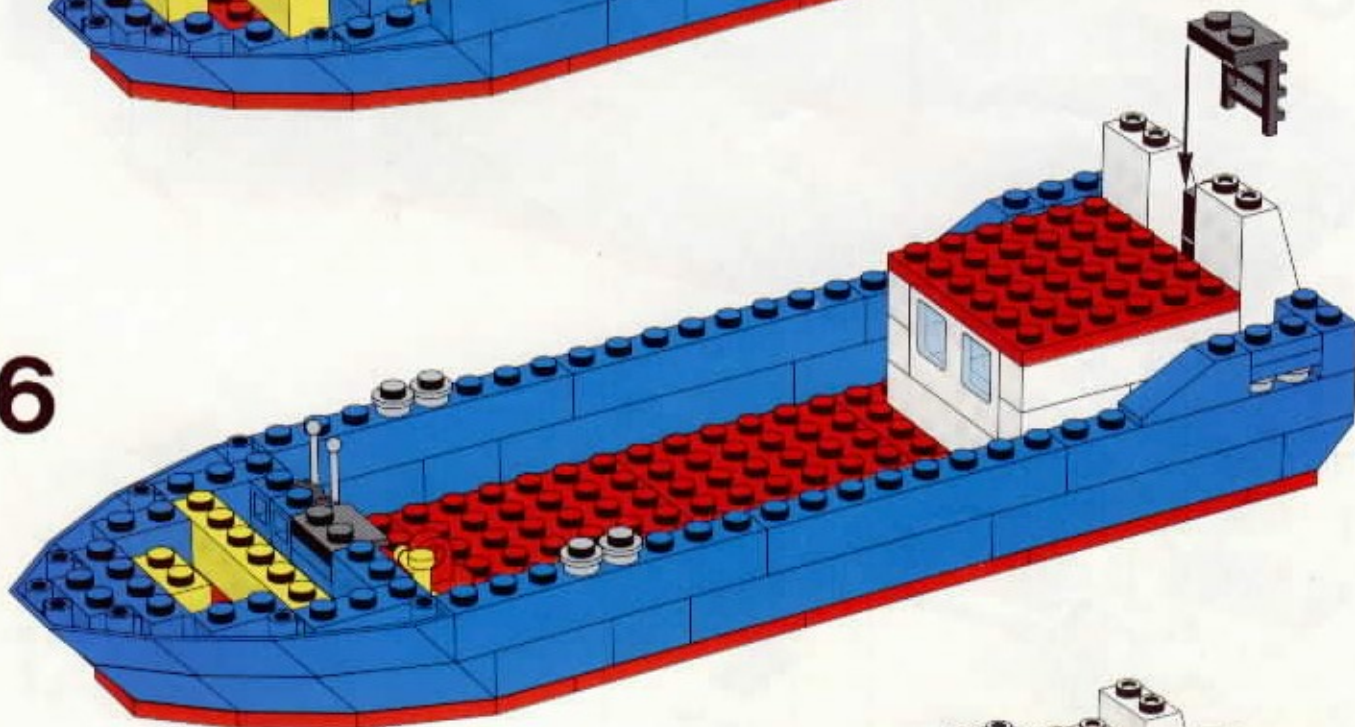

7

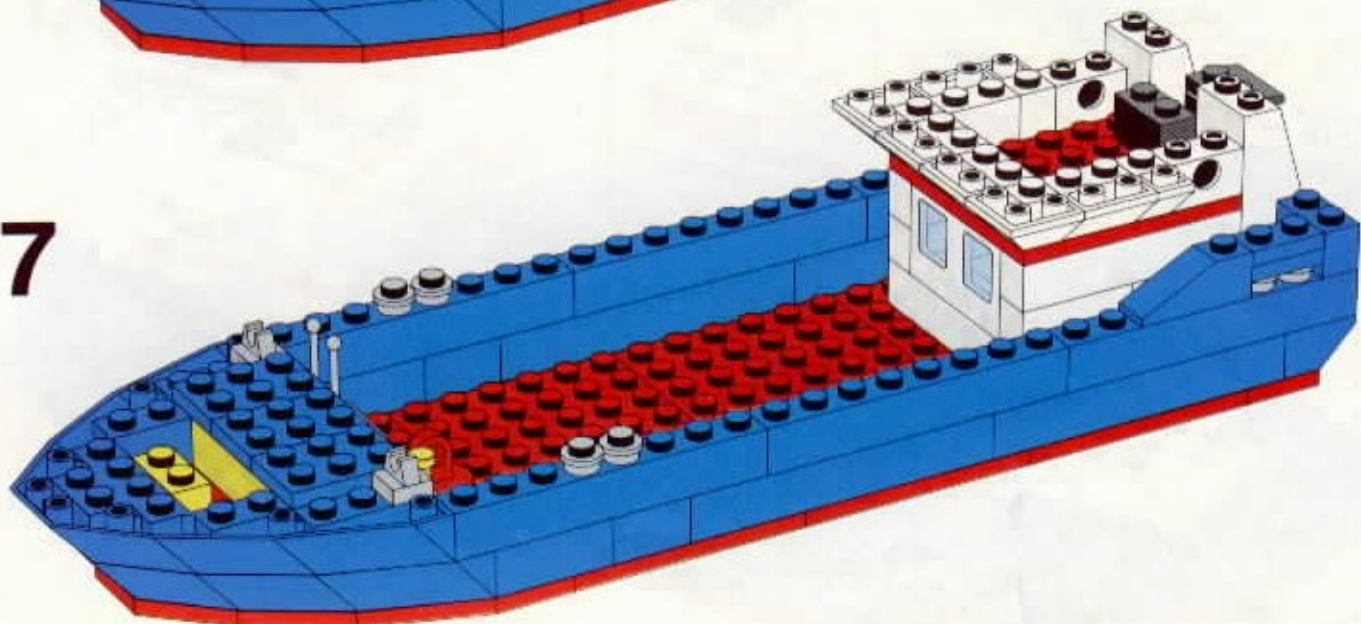

8

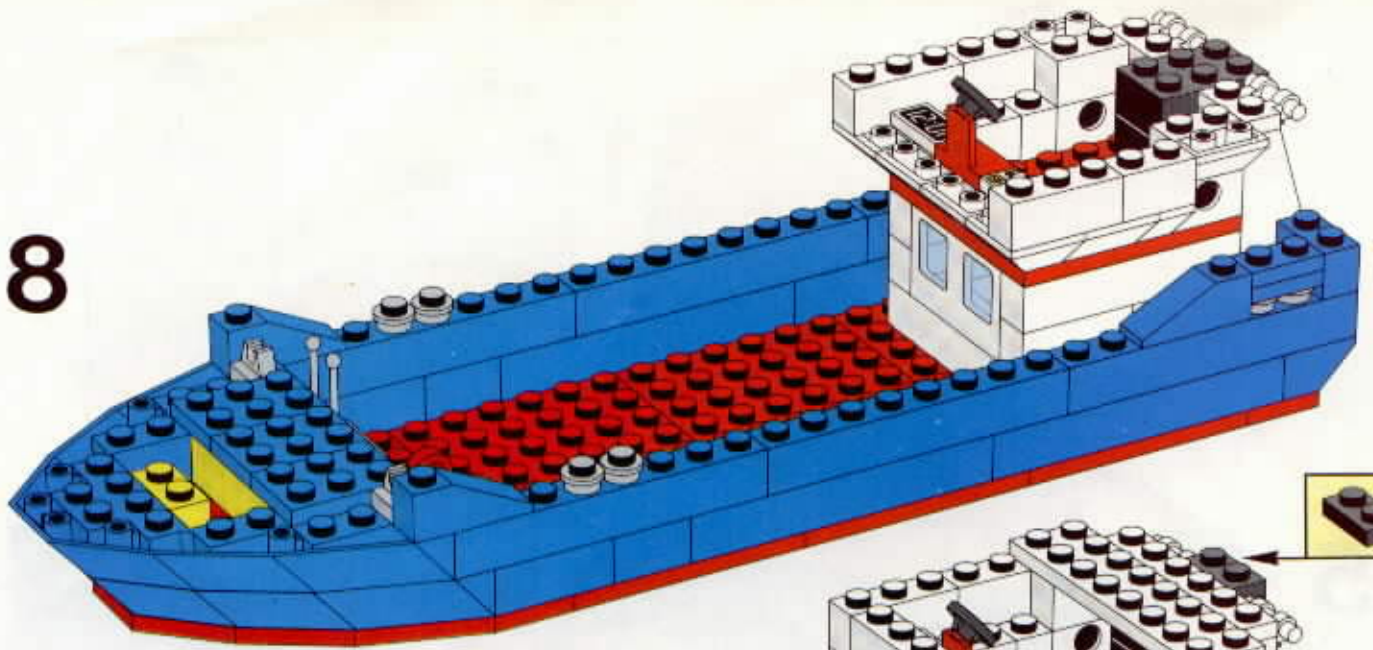

9

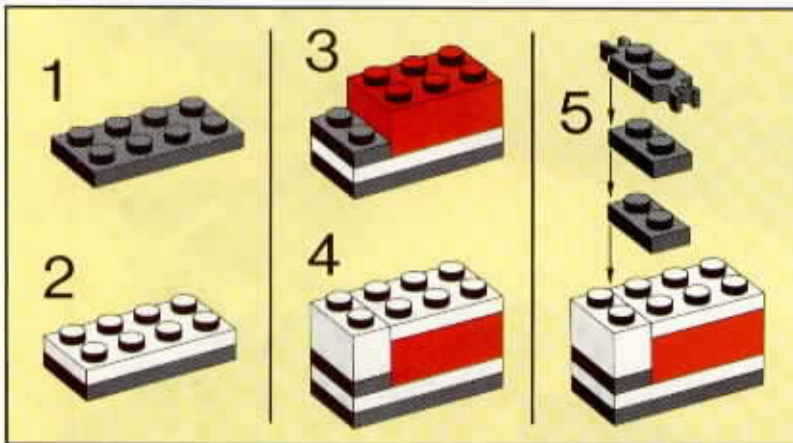
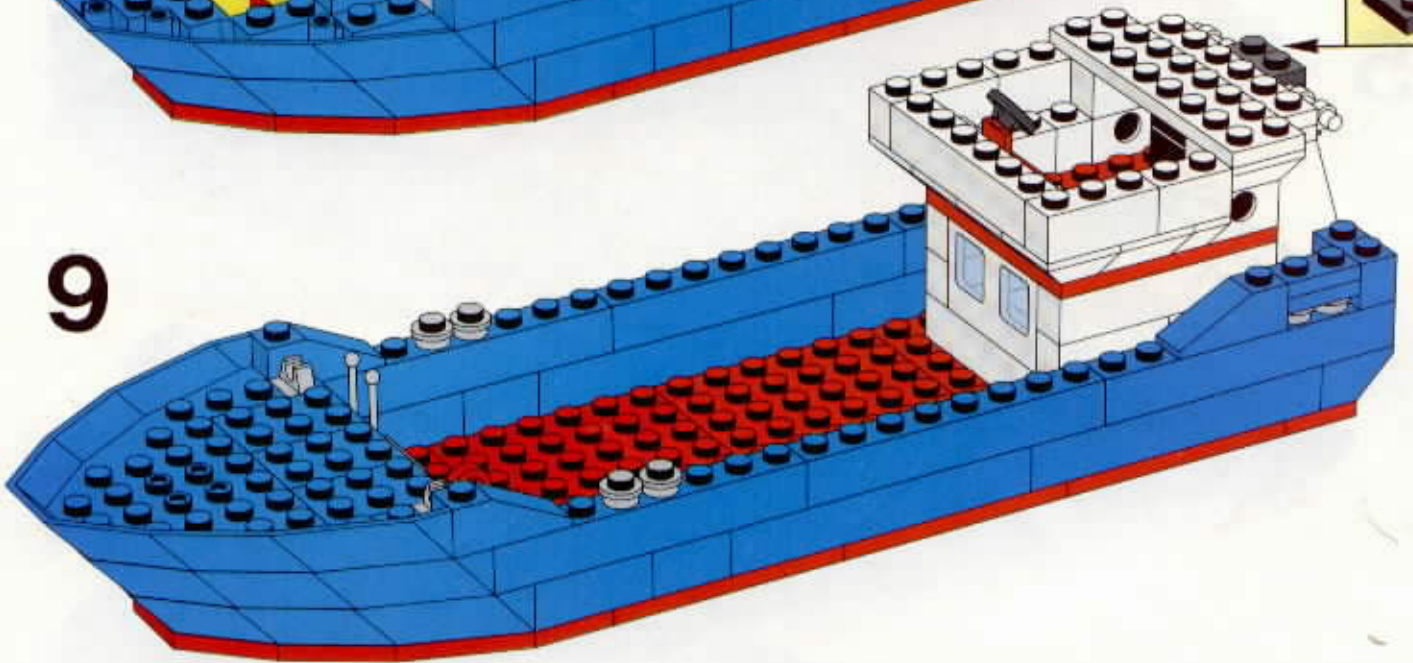

10

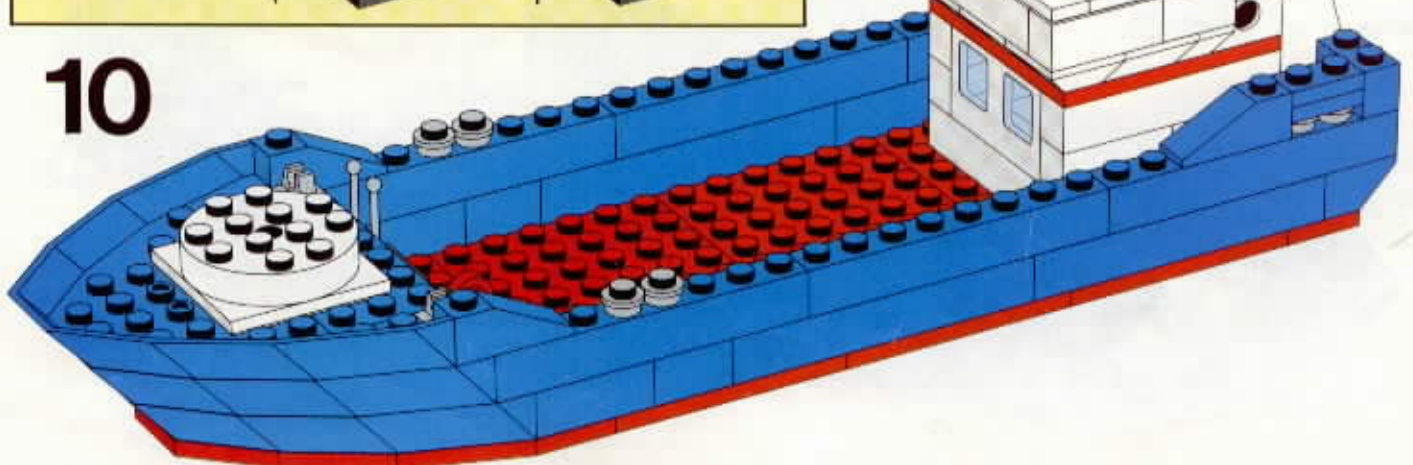

11

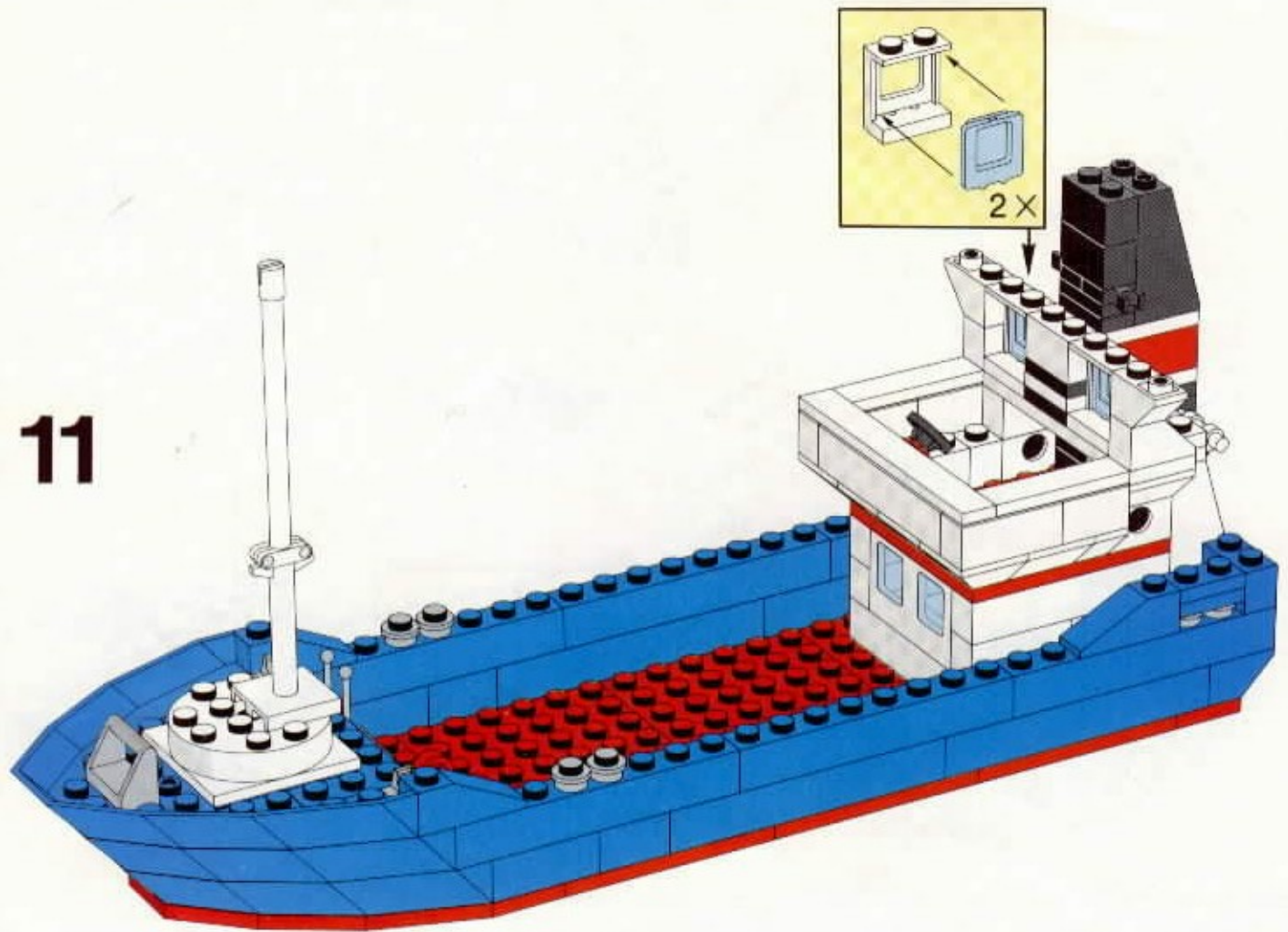

12

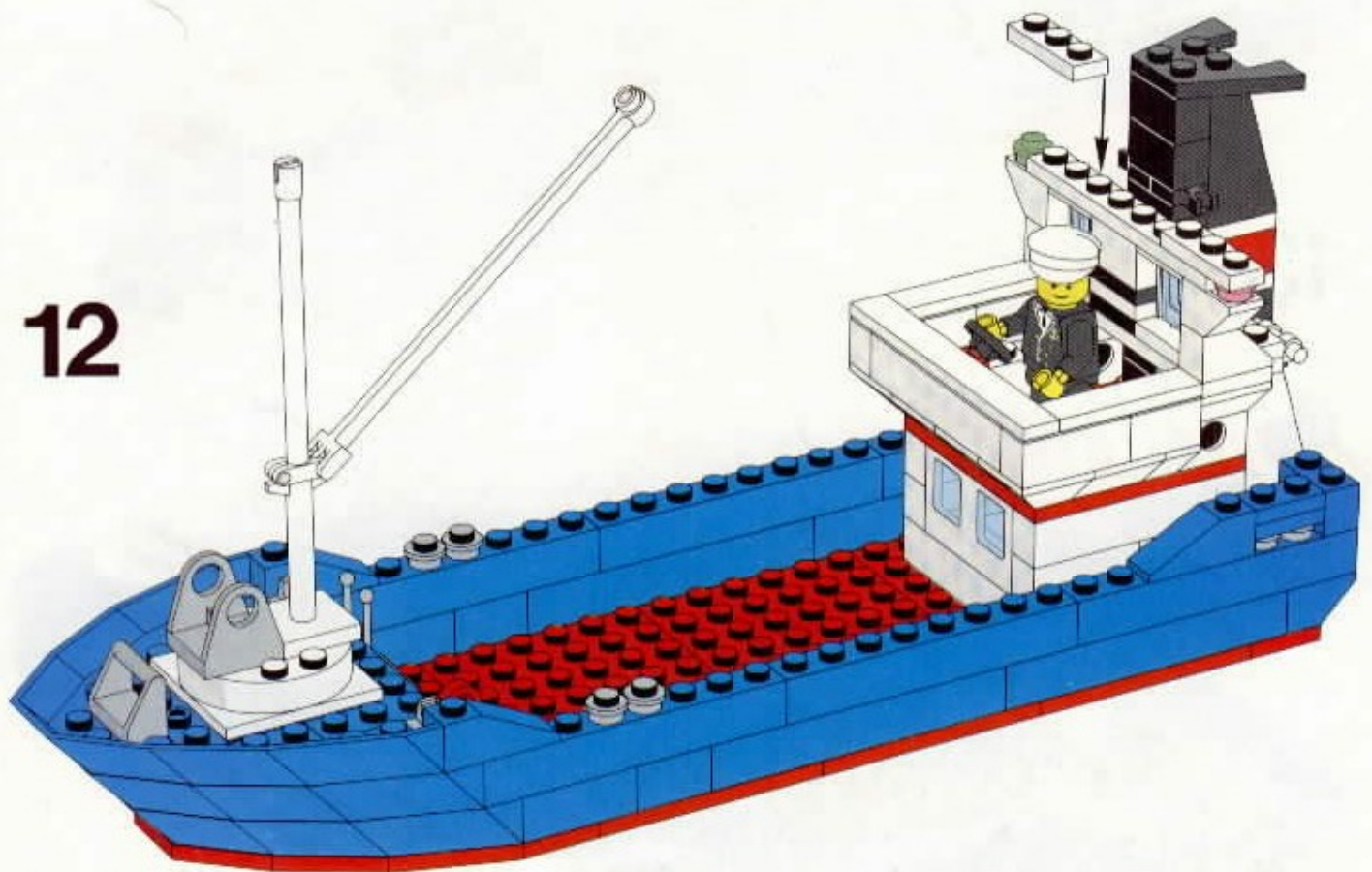

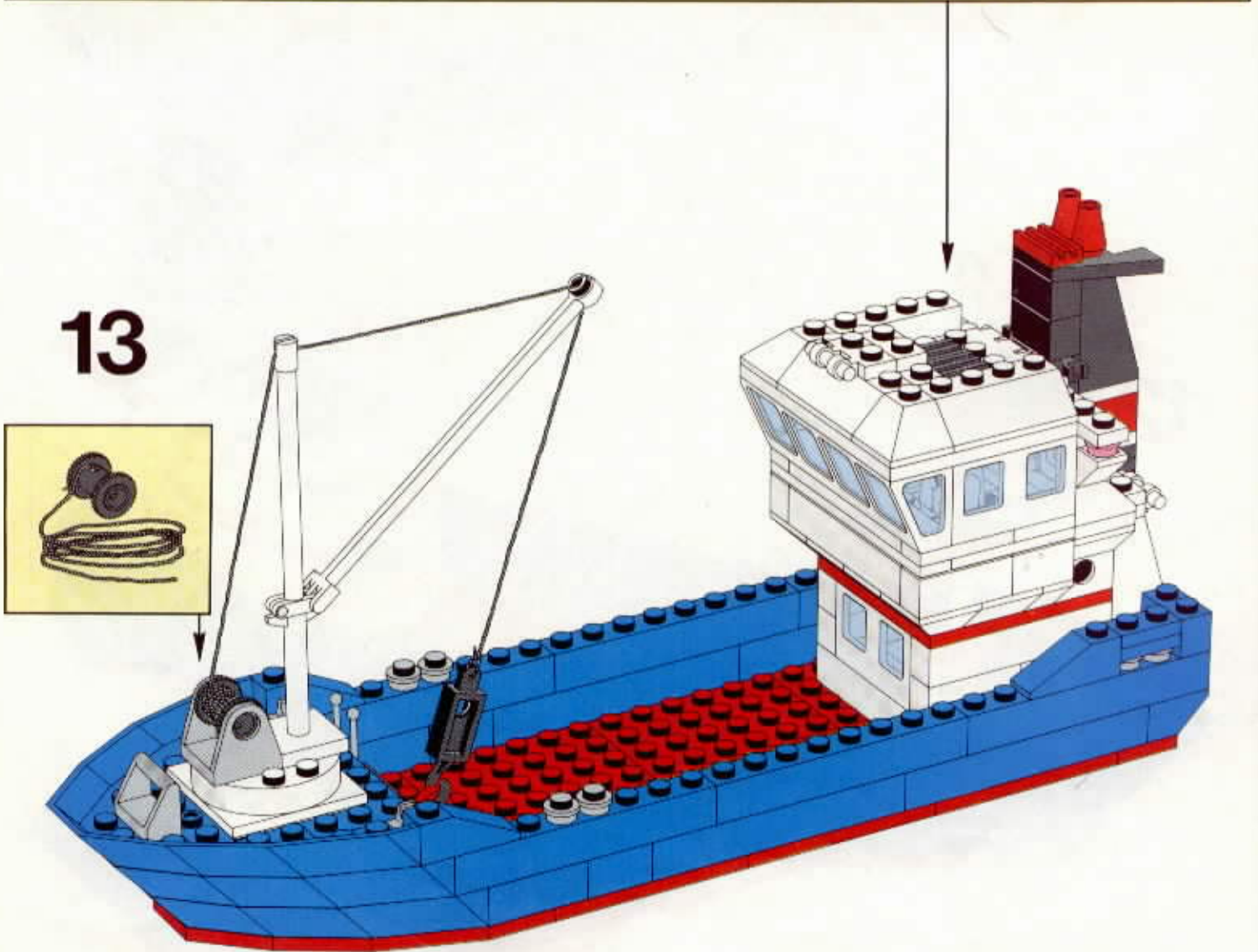
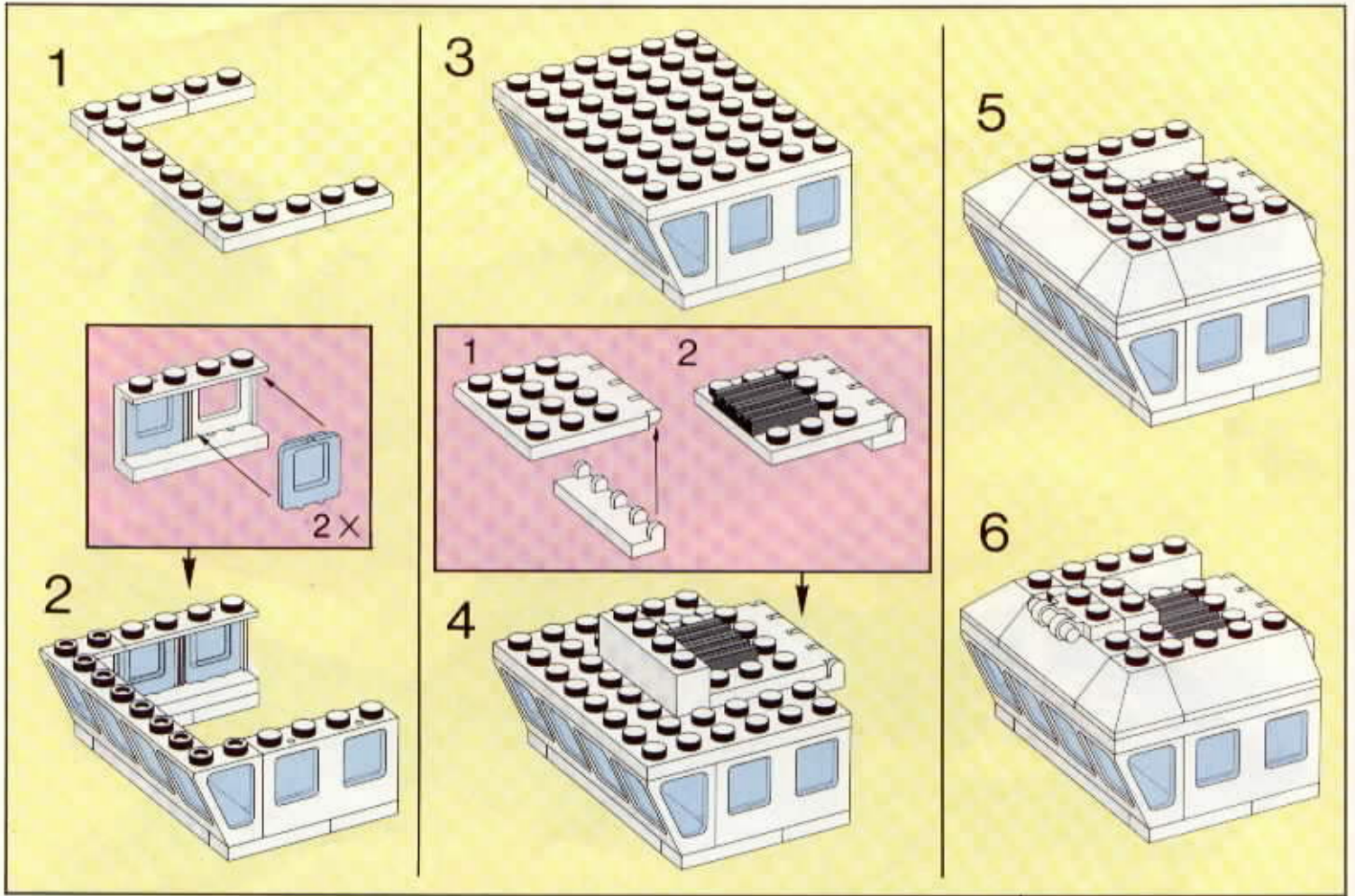

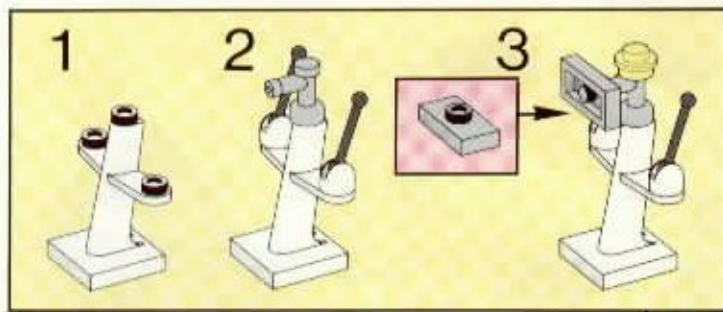

14

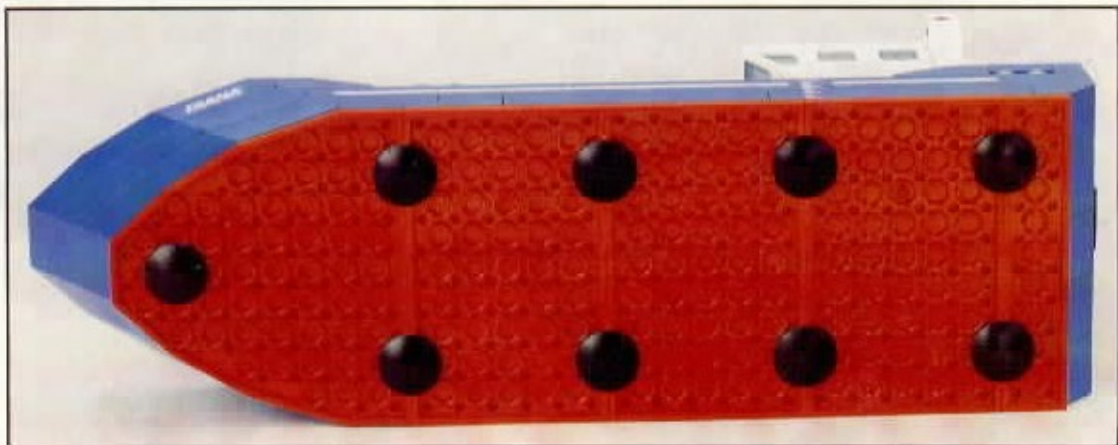
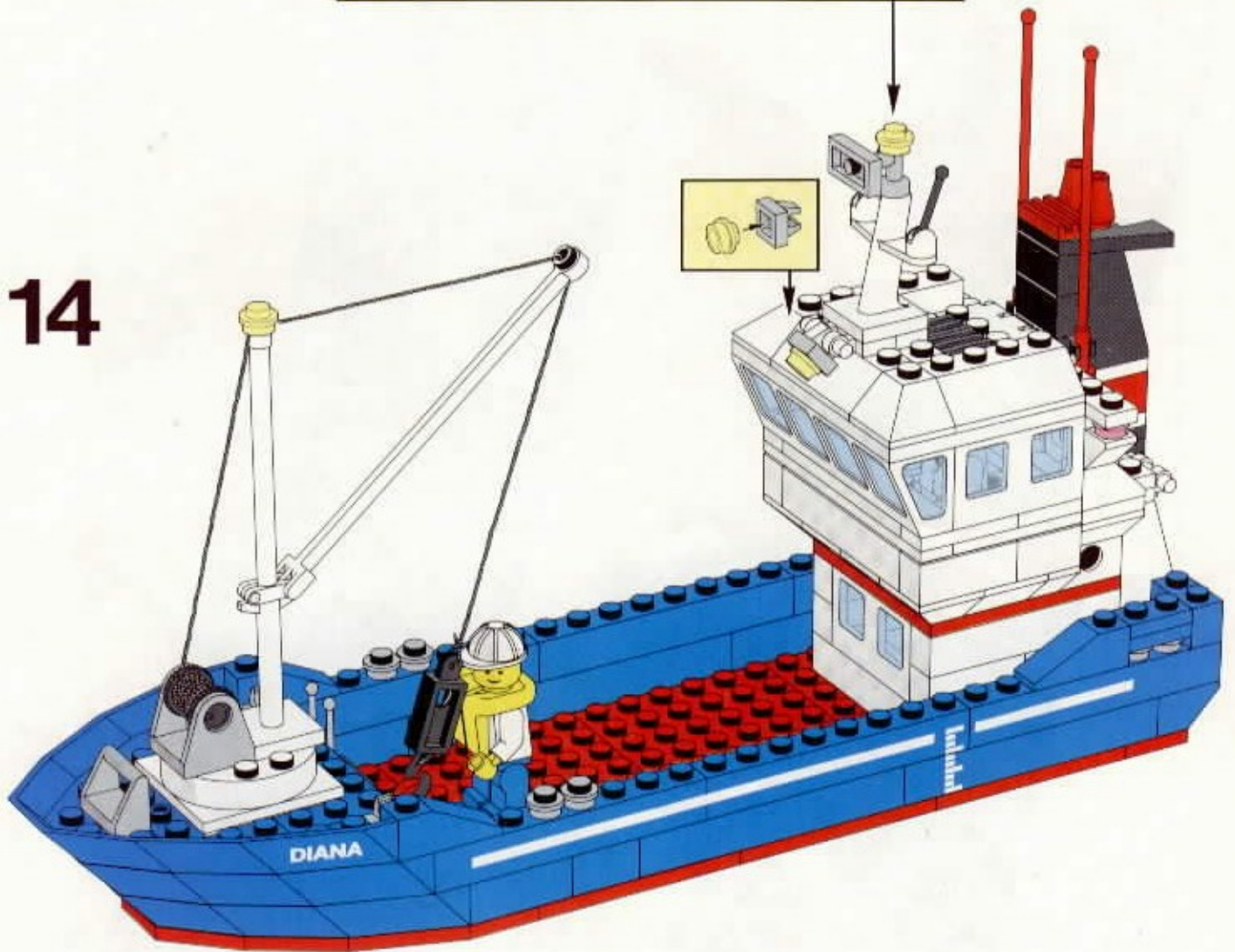

1

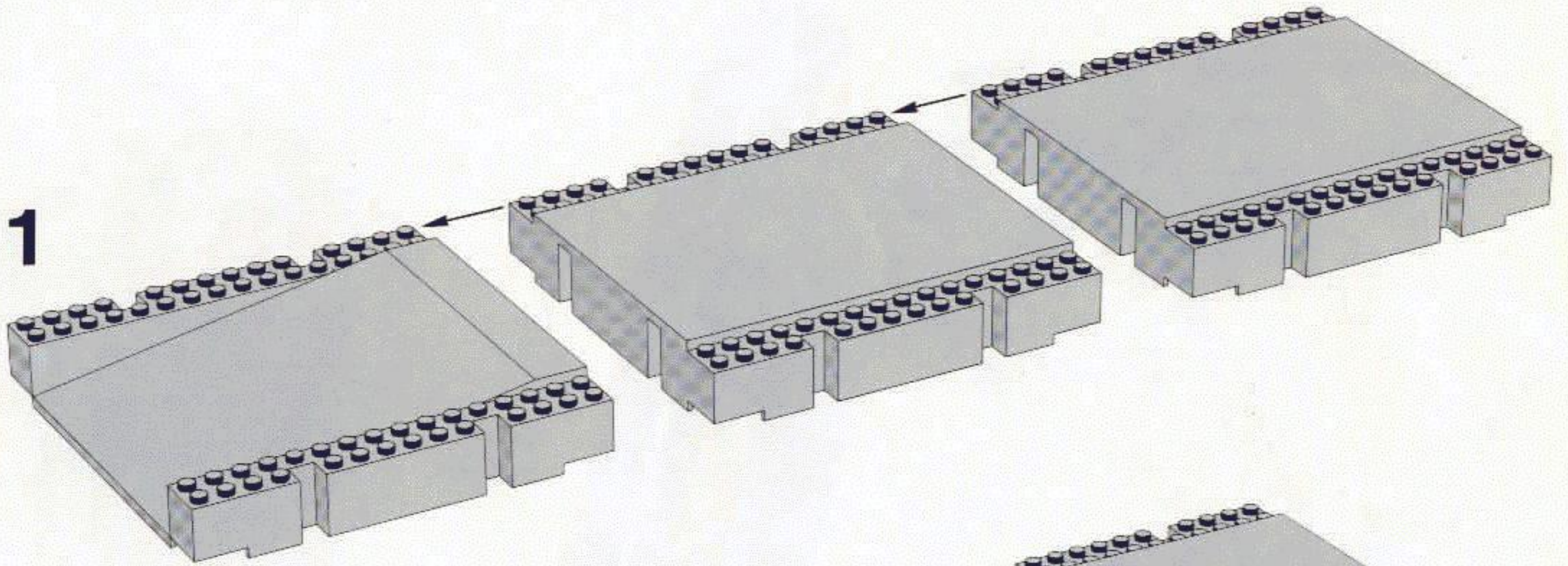

2

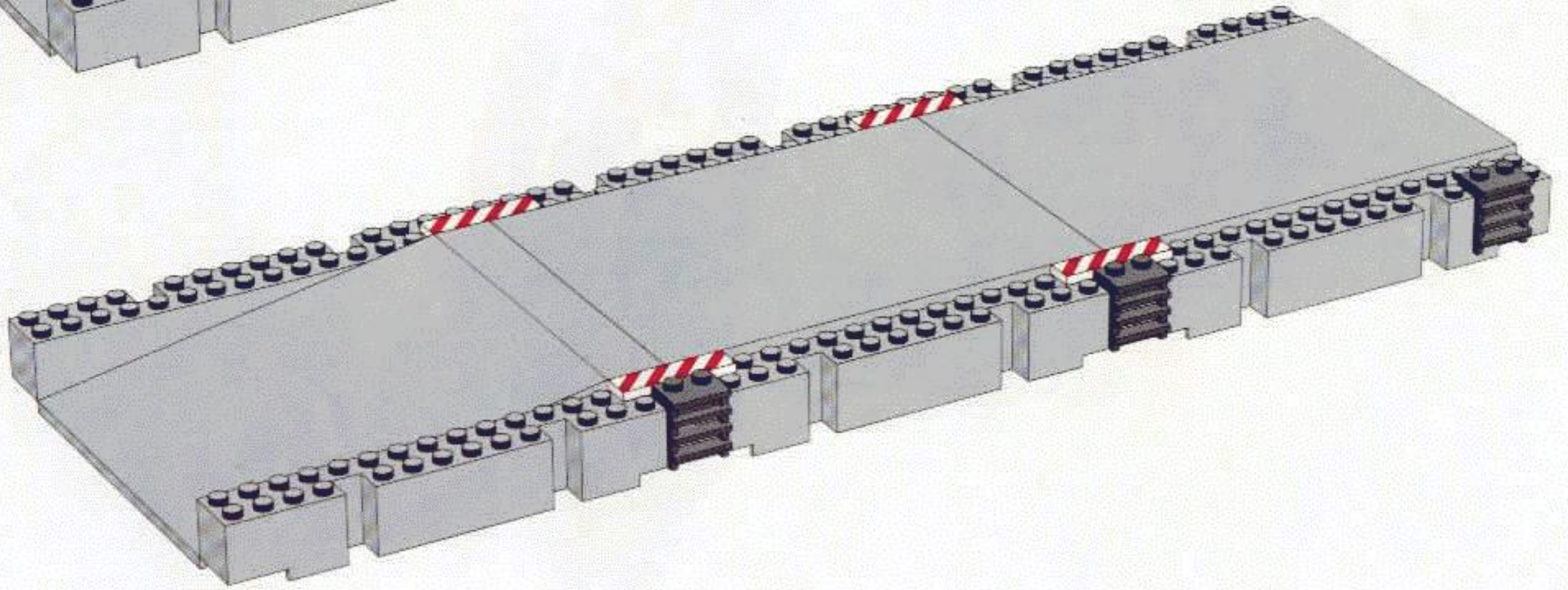

3

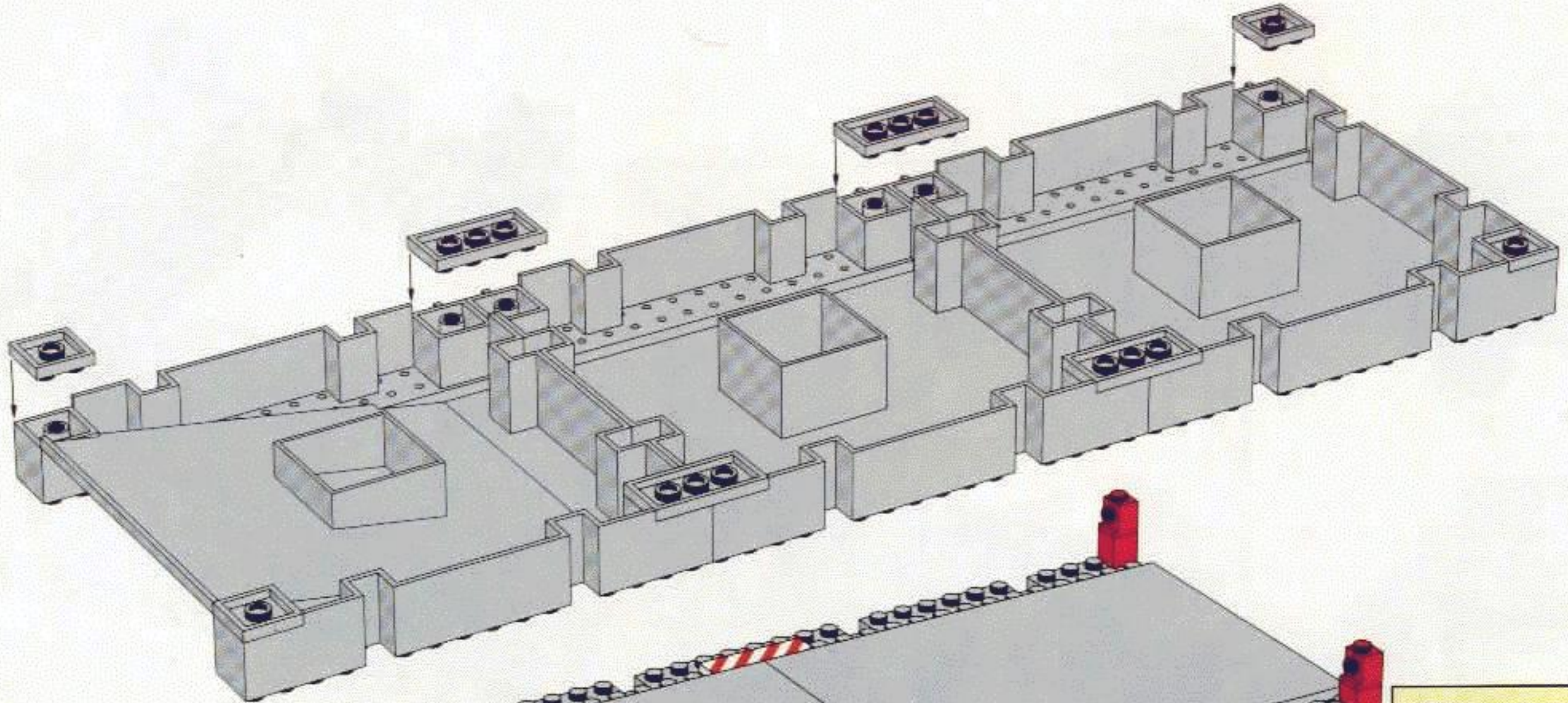

4

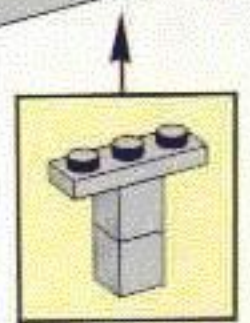
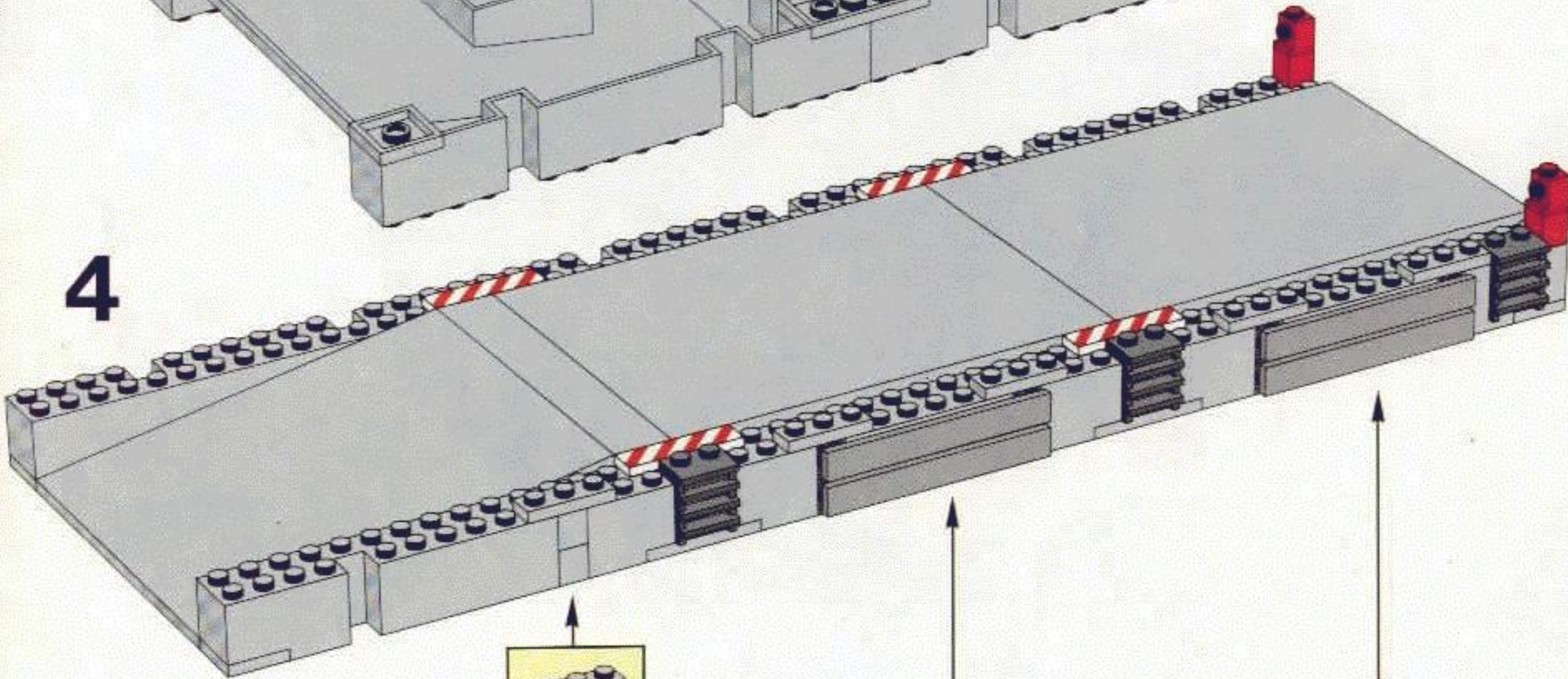

1		
2		
3		

2X

5

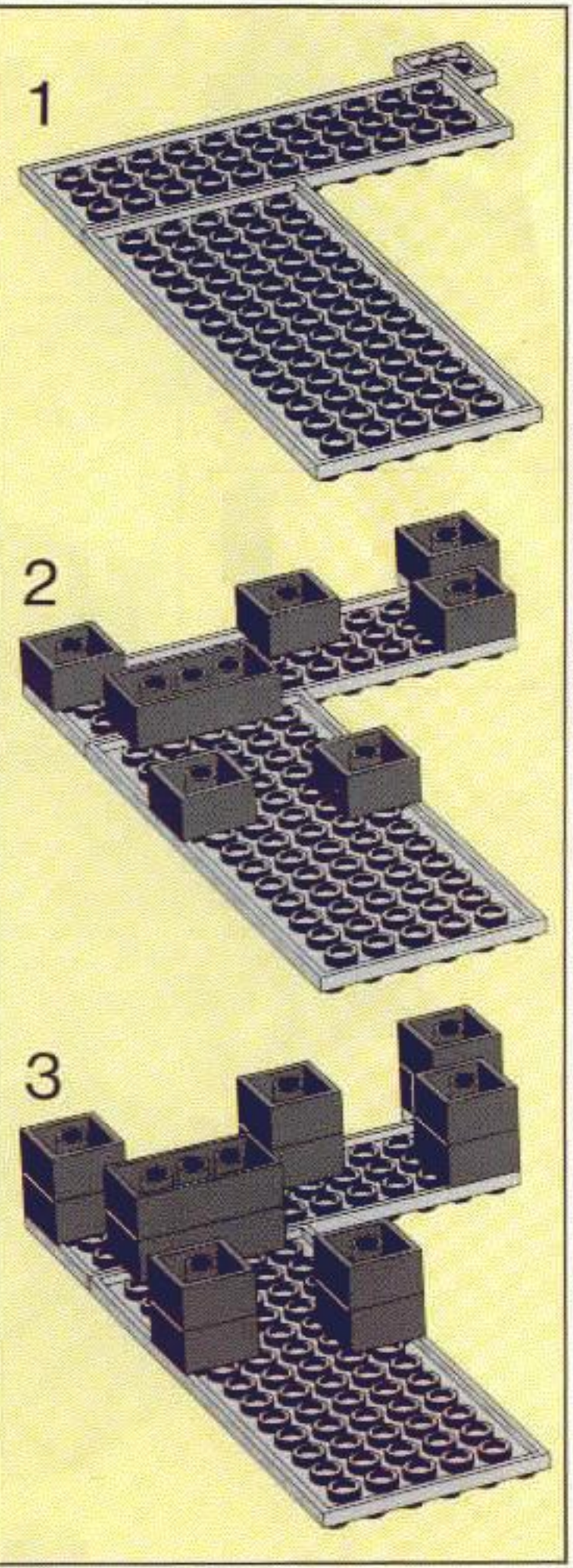
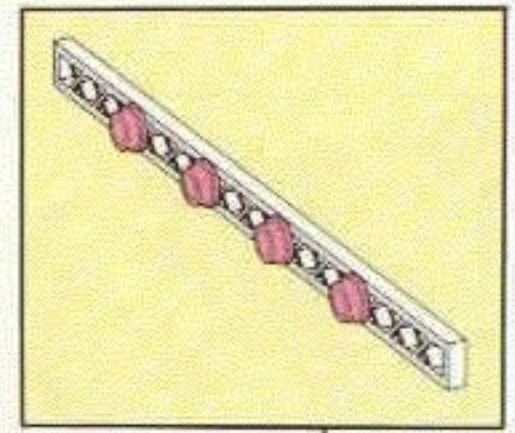
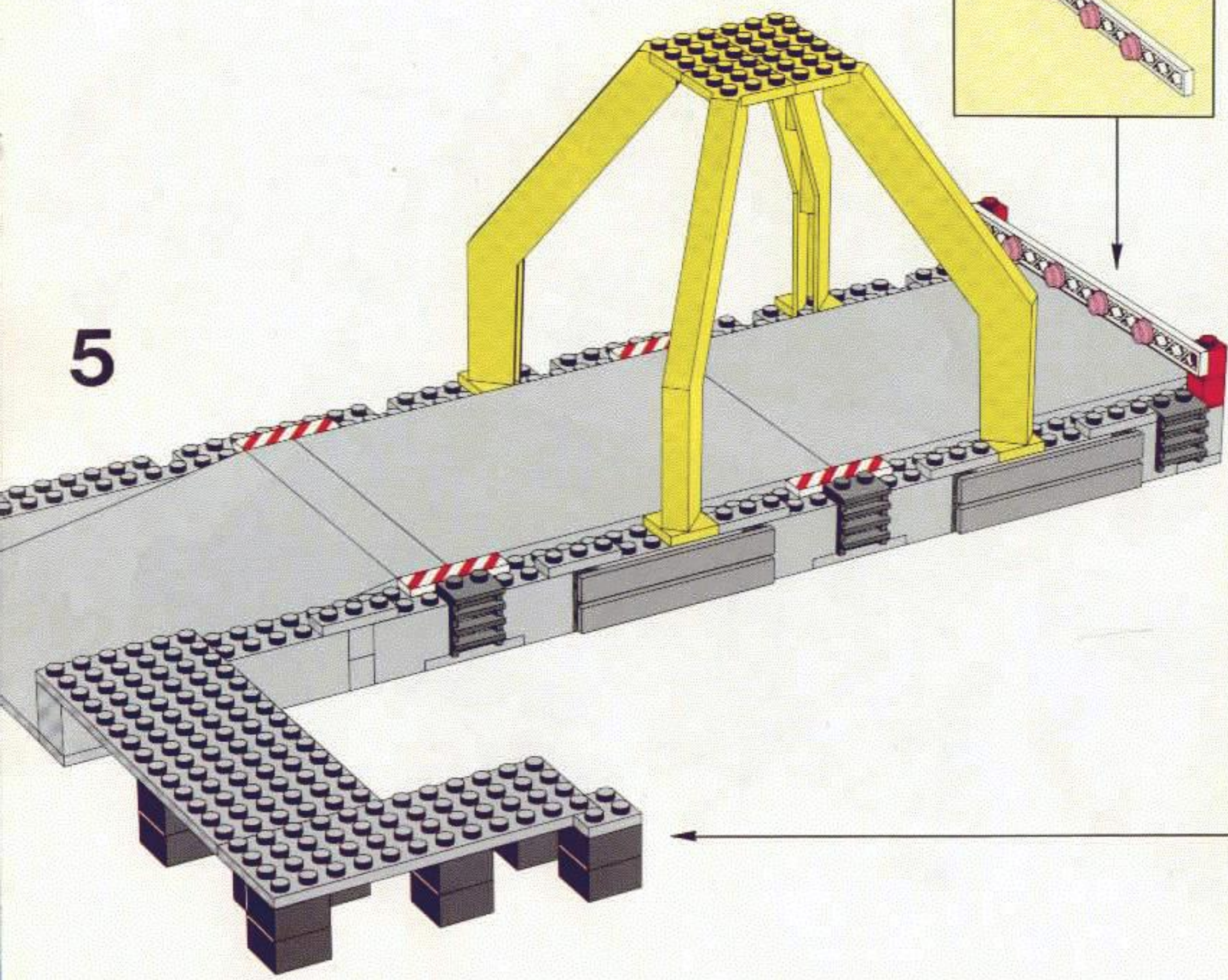

6

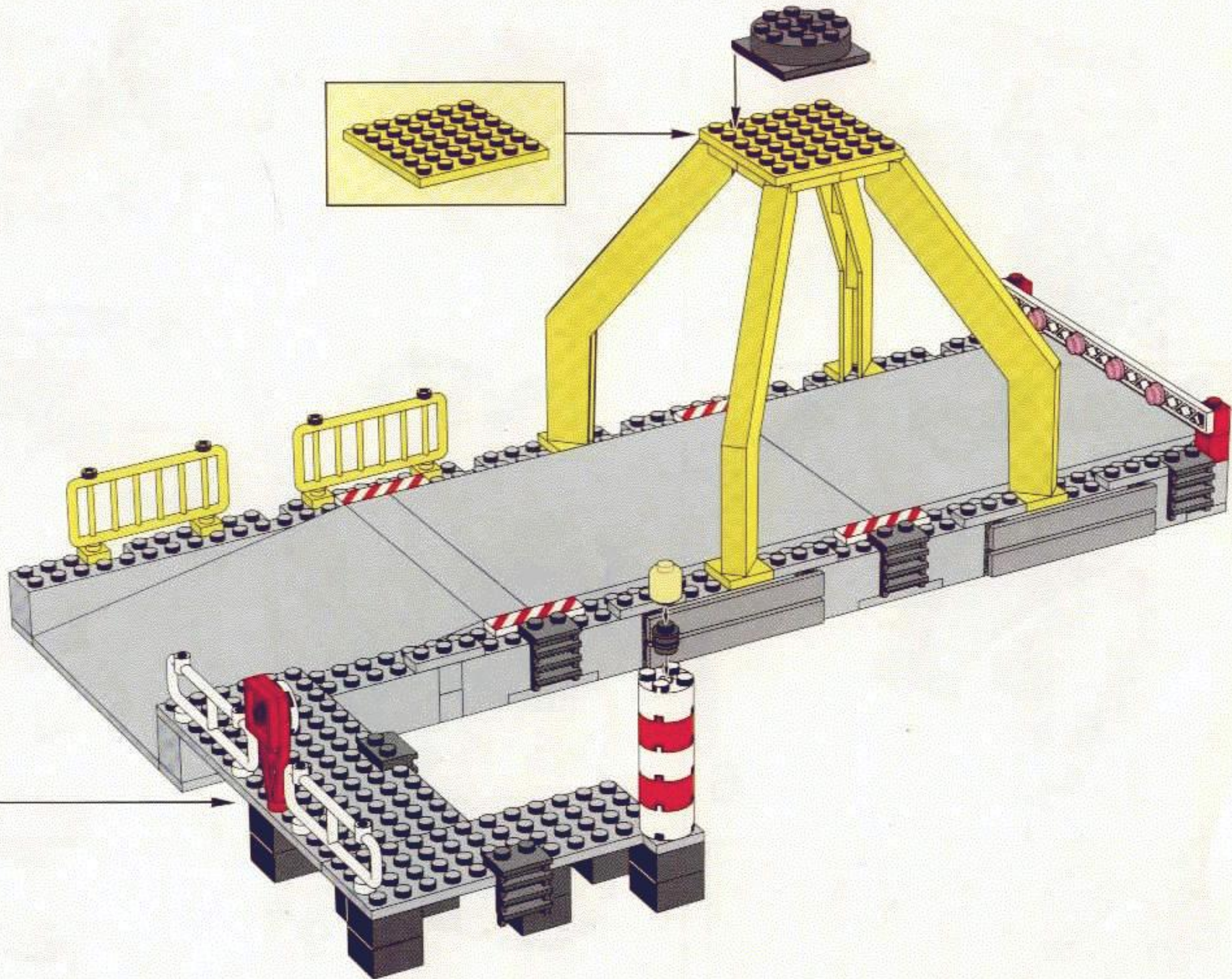
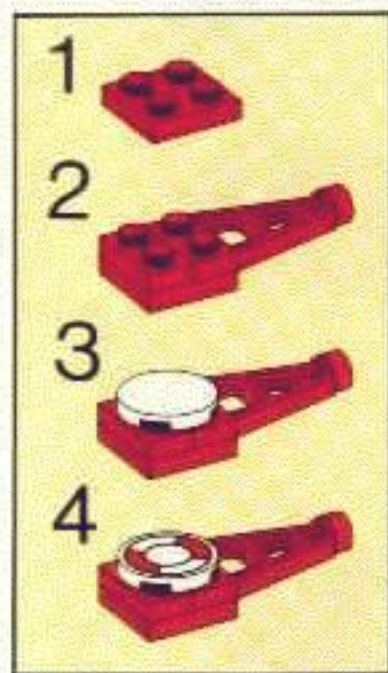

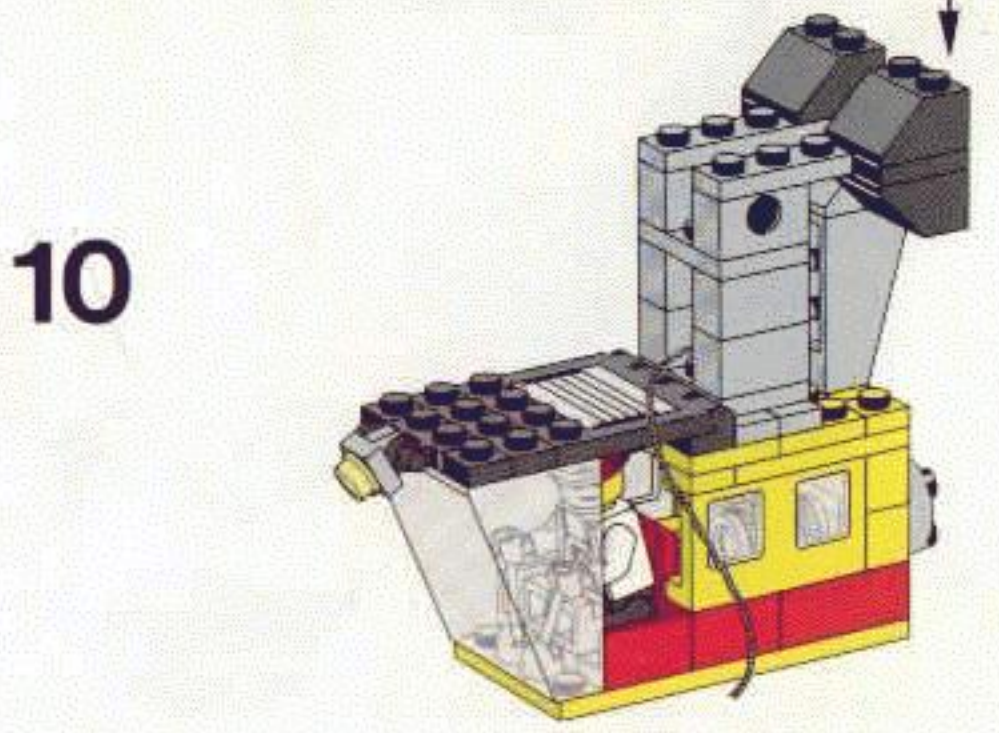
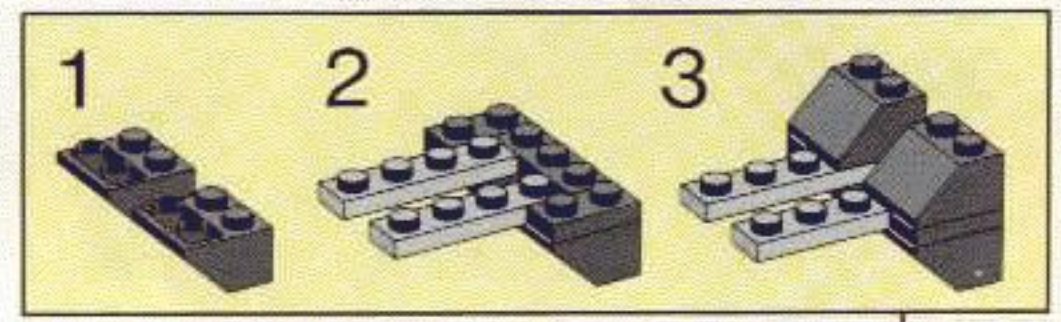
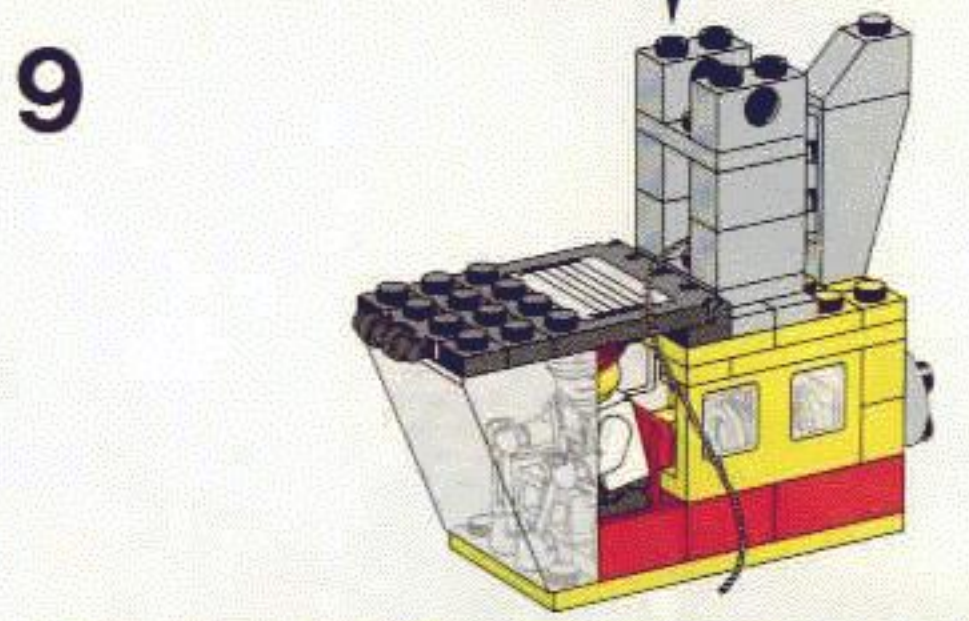
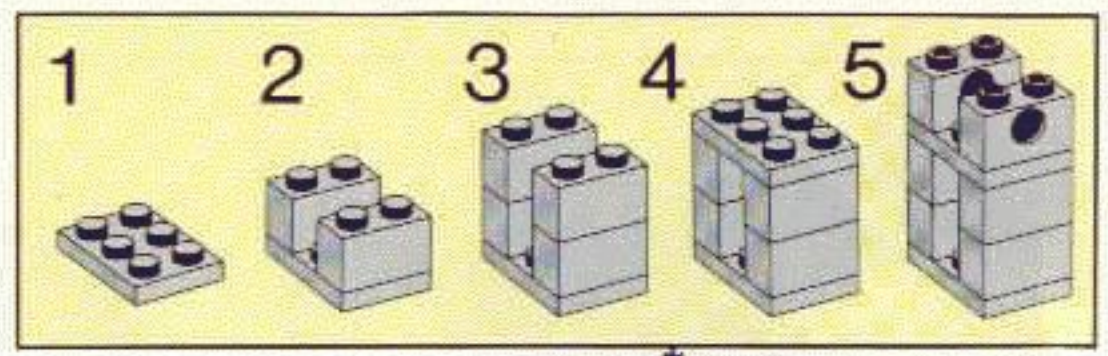
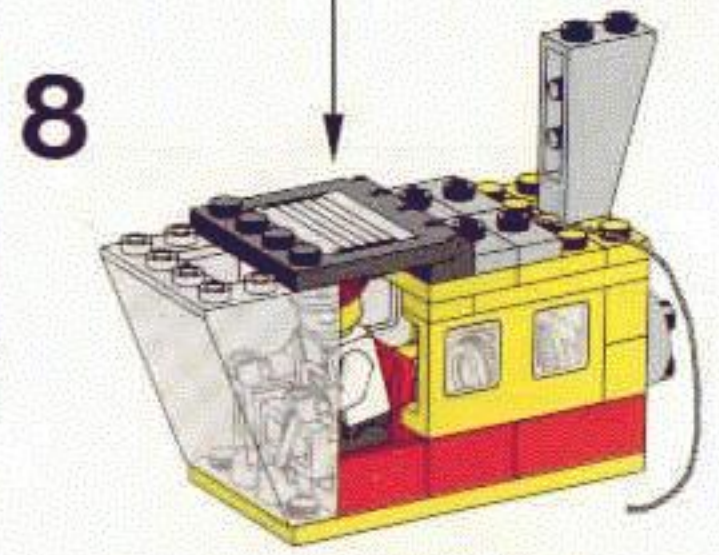
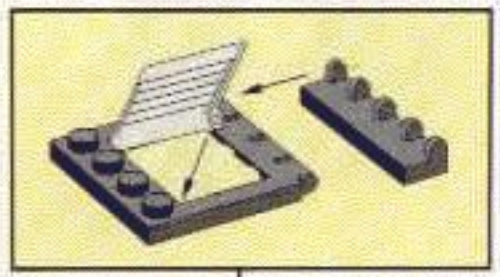
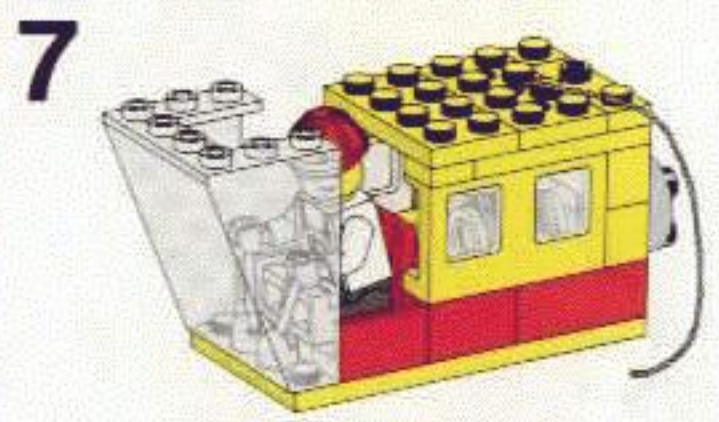
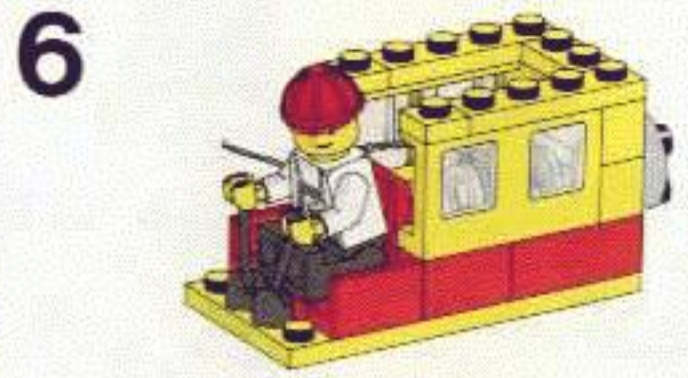
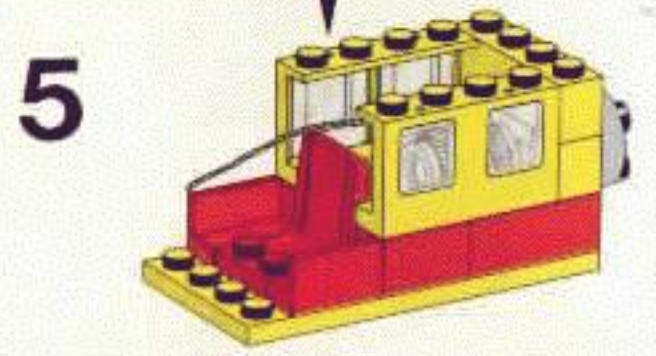
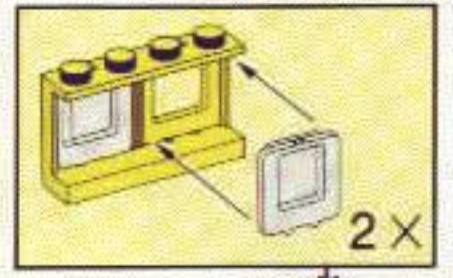
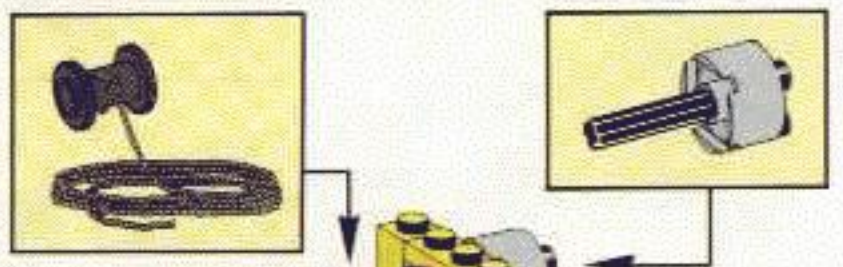
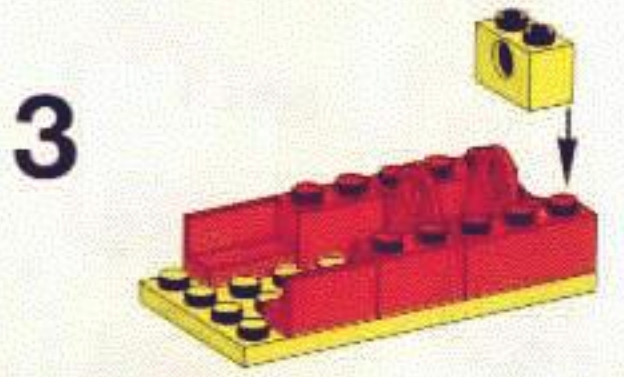
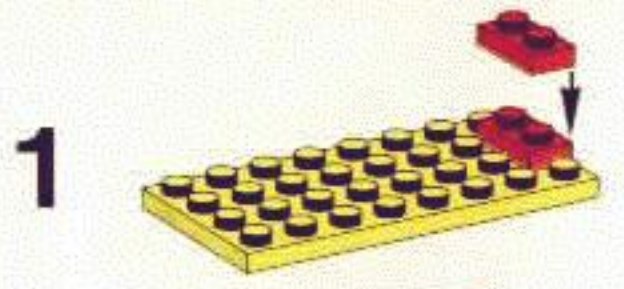

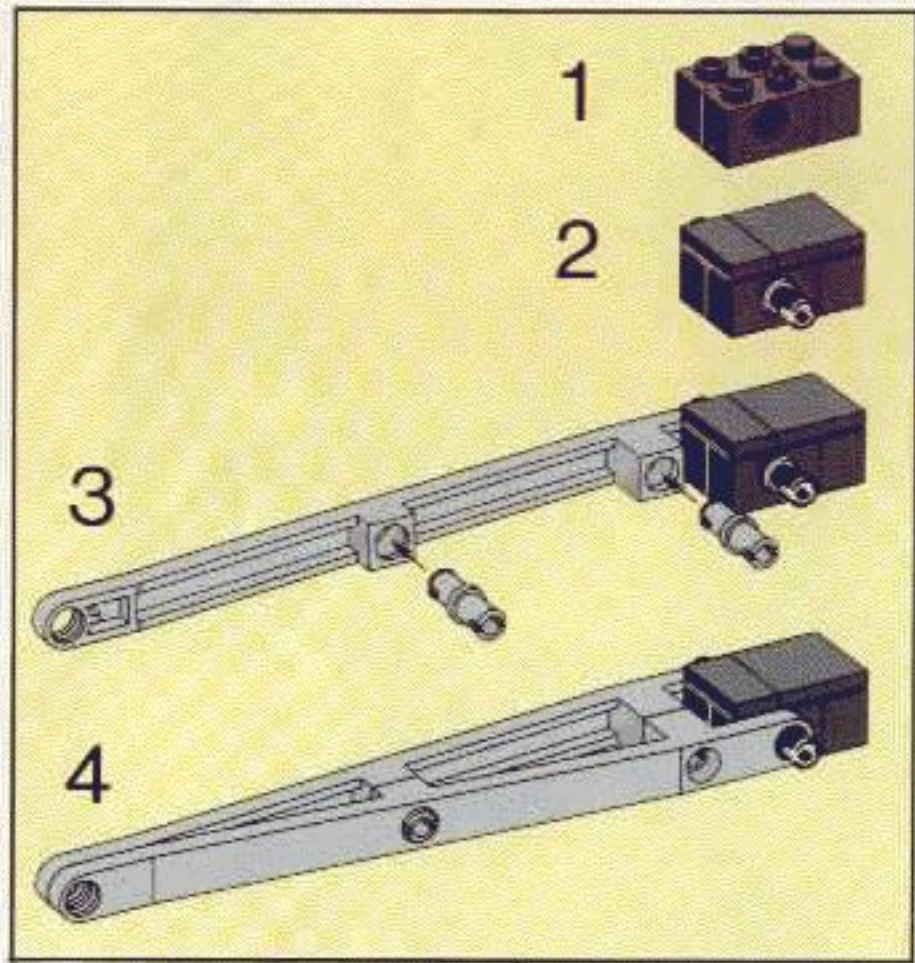

11

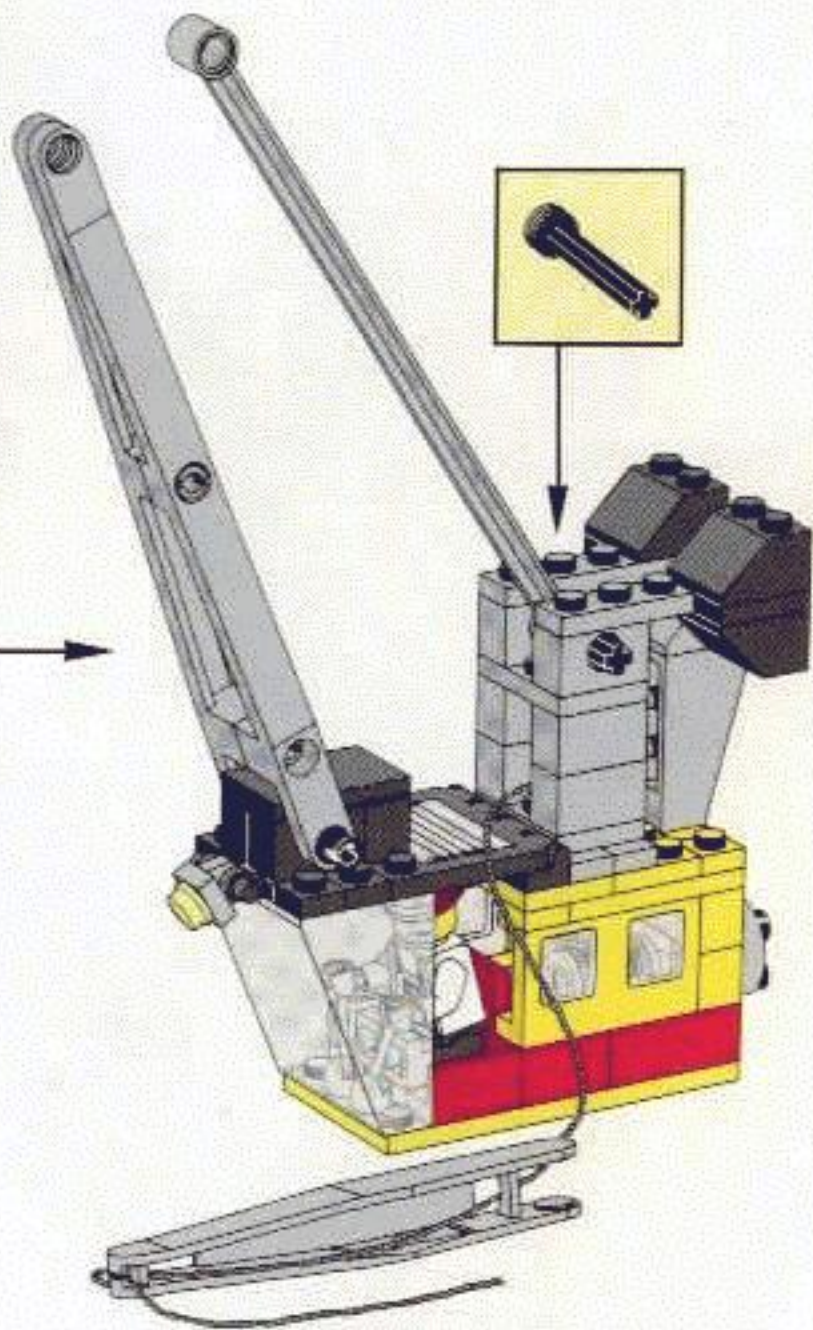

12

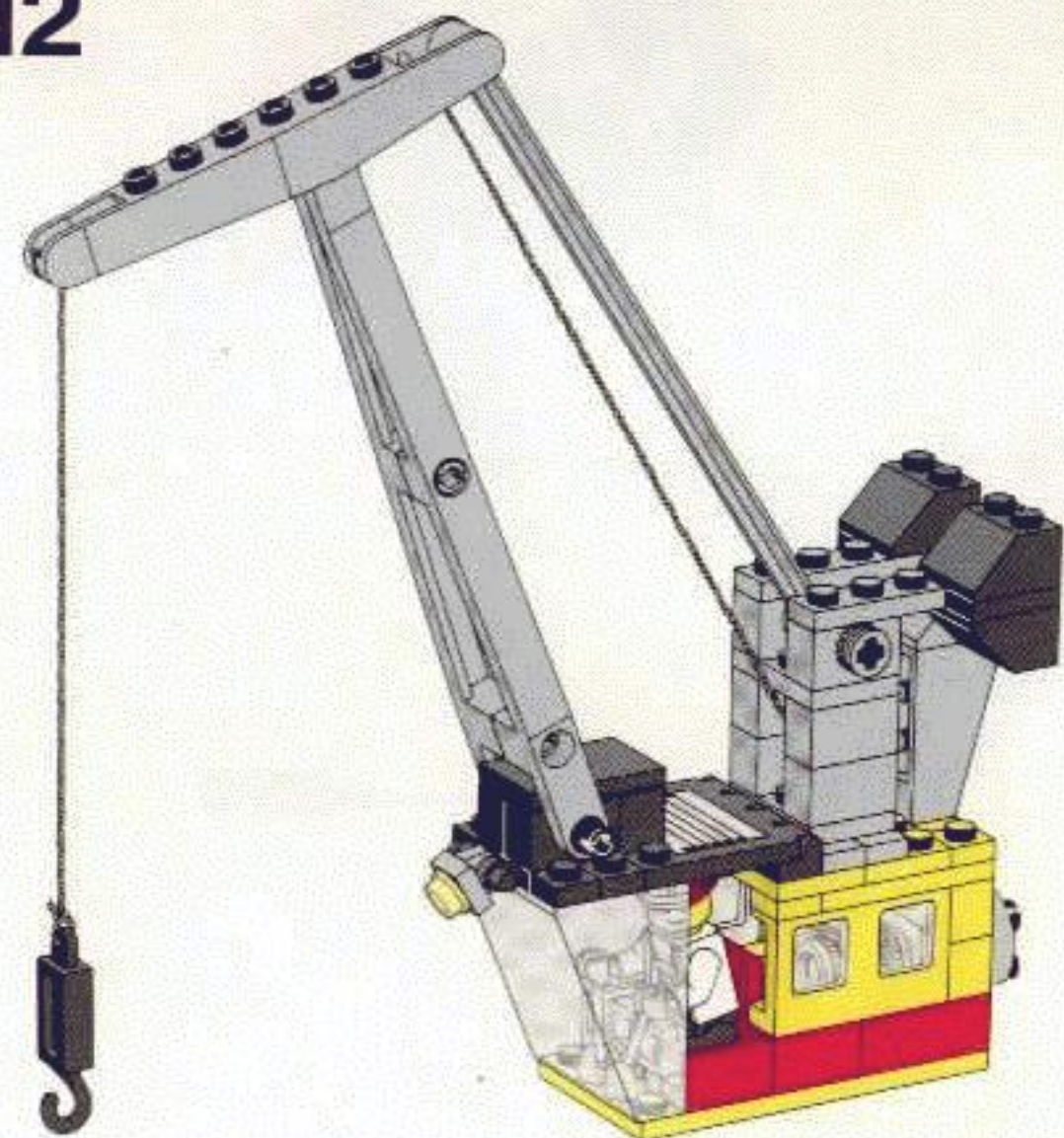

7

