



10681



**Build &  
Rebuild**





**Level of difficulty**  
**Schwierigkeitsgrad**  
**Niveau de difficulté**  
**Nível de dificulad**  
**Nível de dificuldade**  
**Nehézségi szint**

Easy / Leicht / Facile /  
Fácil / Fácíl / Könnyű



Medium / Mittel / Moyen /  
Medio / Médio / Közepes



Hard / Schwer / Difficile /  
Difícil / Díficil / Nehéz





1



2



3



4



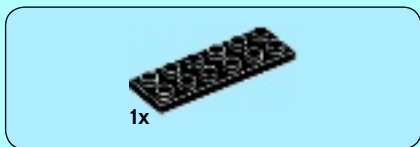

1

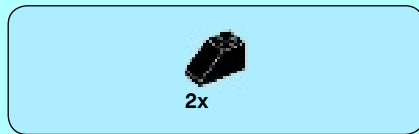
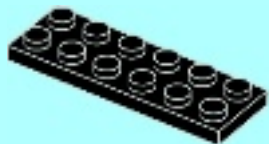

2

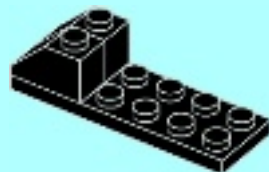



3

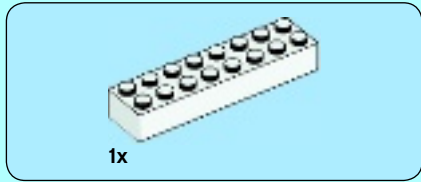

4







5

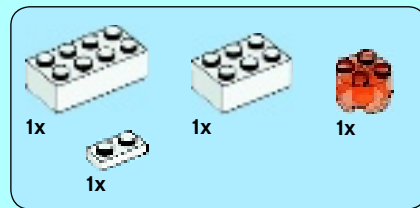
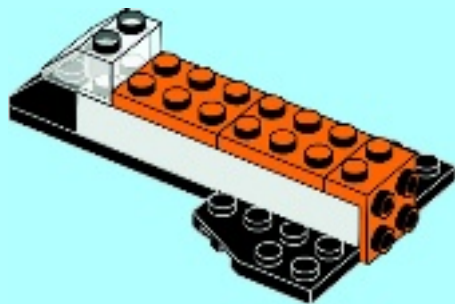

6

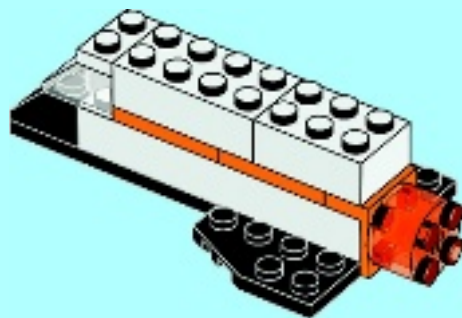



2x

7

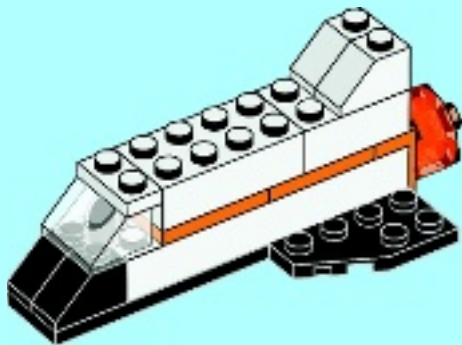

8



2x



2x



1x



1x

8

1





2

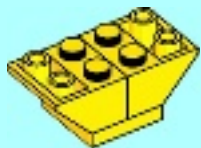

3

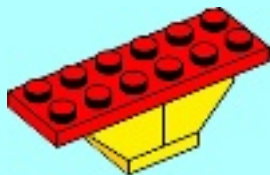

4





1x



1x

1



1x



1x

2

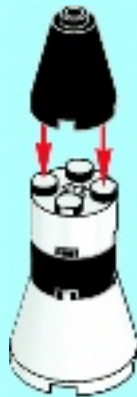



1x

3

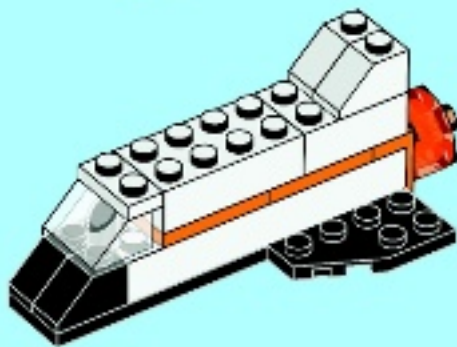
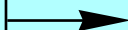

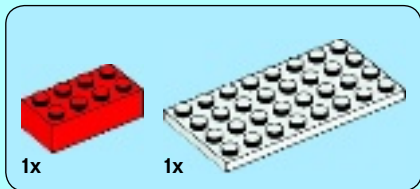

1

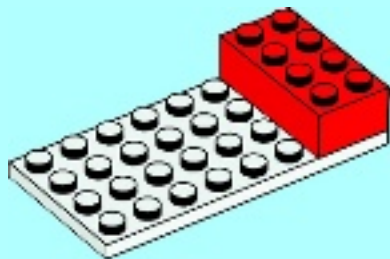

2

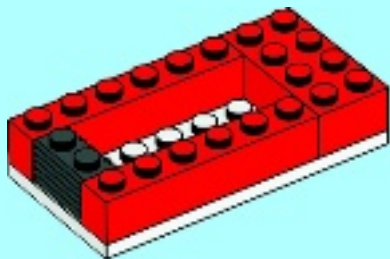



1x



1x

# 3

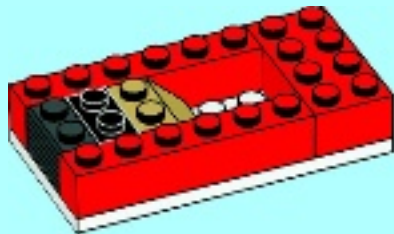

2x



2x

# 4

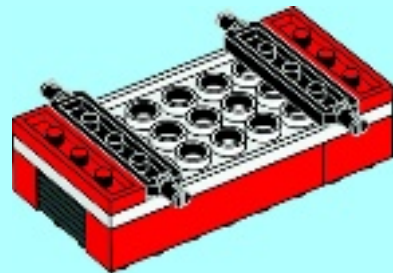
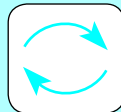



5

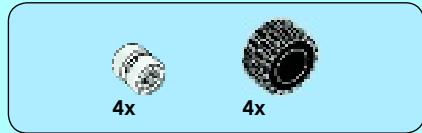
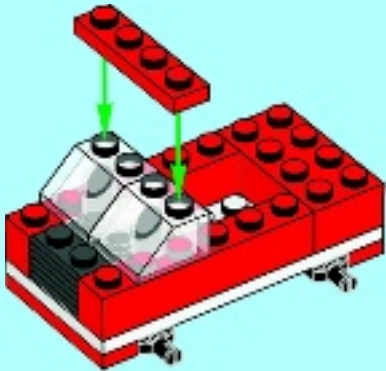
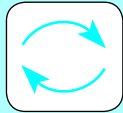

6

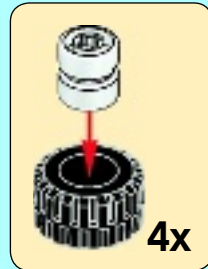
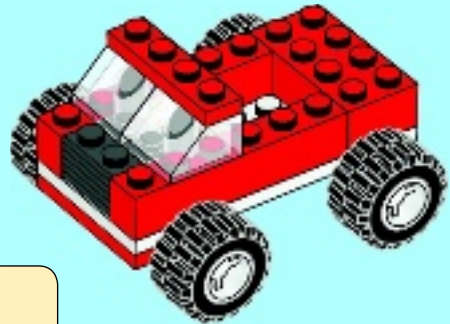



1

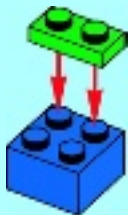

2

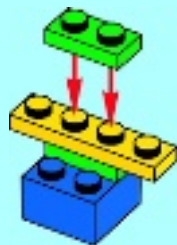





1x

3

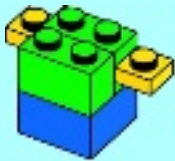

1x



1x

4





1x

5

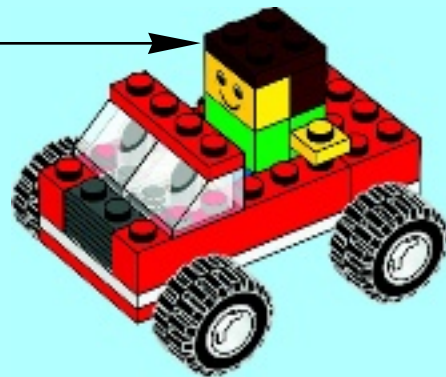

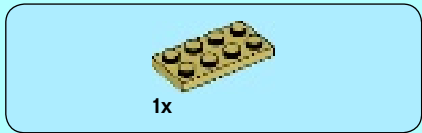
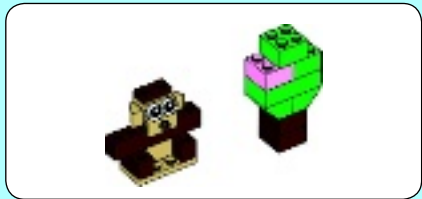

**1**

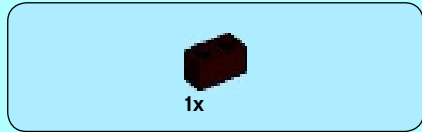
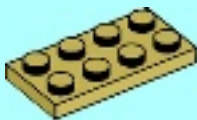

**2**





1x



1x

3

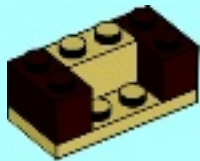

1x

4

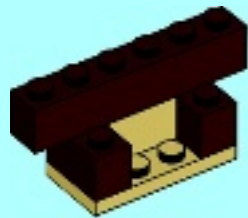

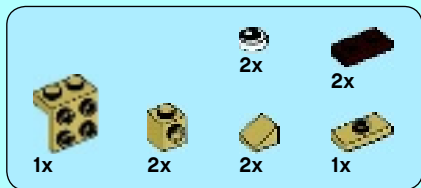

5

1



2



3

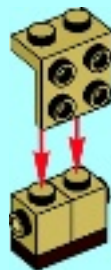

4

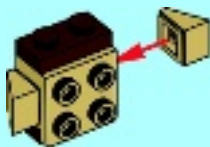

5

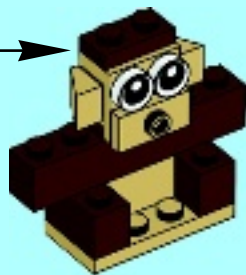
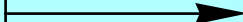

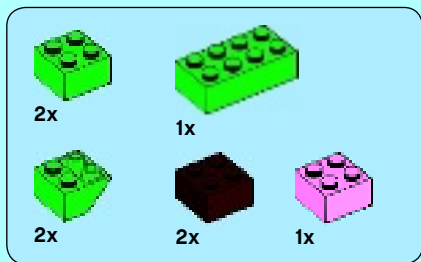

6

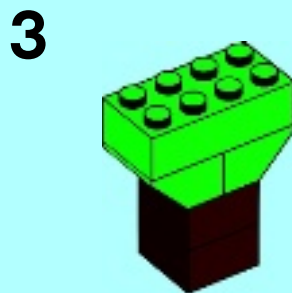
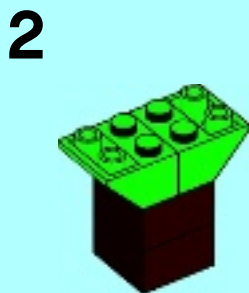
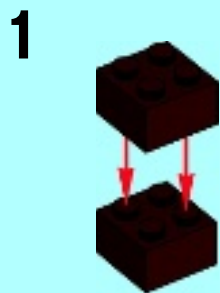



4

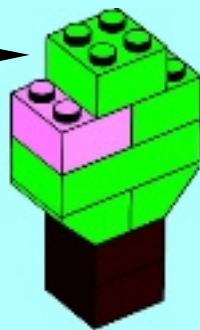
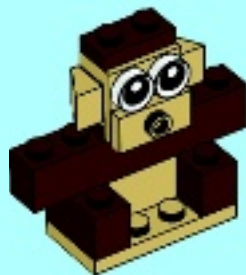
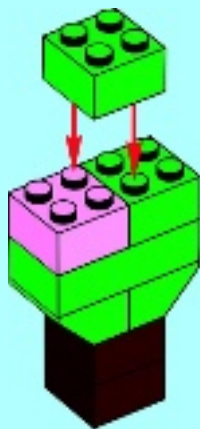



1x

1



2x

2





1x

3



1x



1x

4

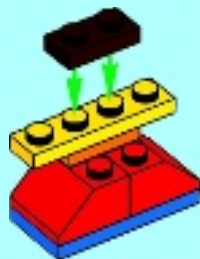



1x

5



2x

6





1x

7



1x

8





1x



1x

1

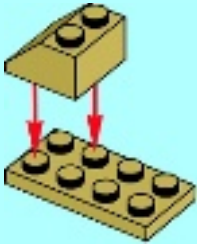

1x



1x

2

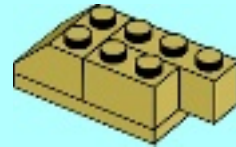



1x

3

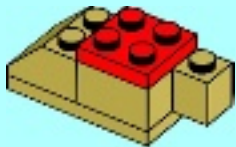

1x

4

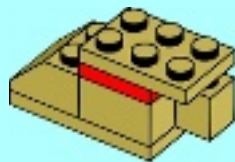





2x

5

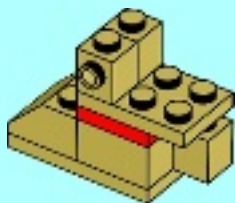

2x

6

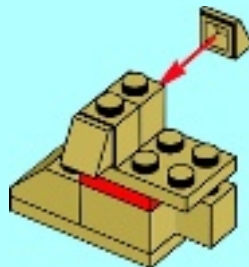



1x



2x

7

1

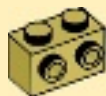

2

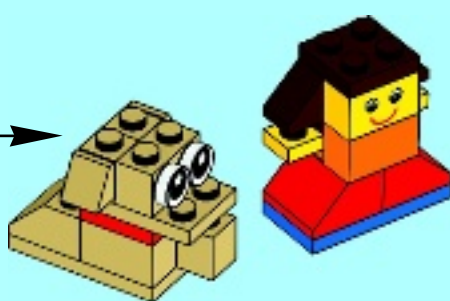
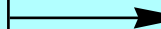
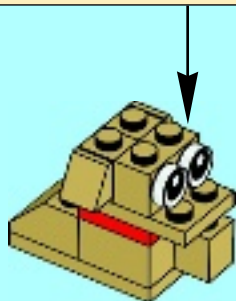



1x

1

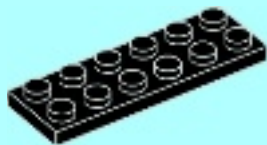

1x

2x

2

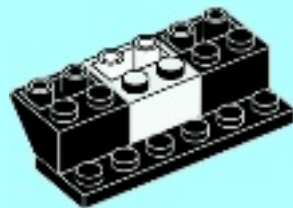



2x



1x

# 3



3x

# 4

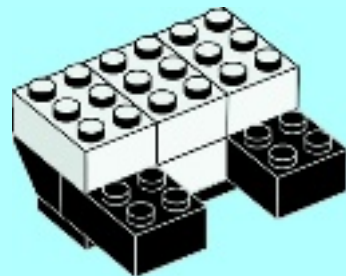

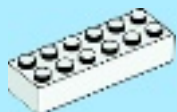

1x

5

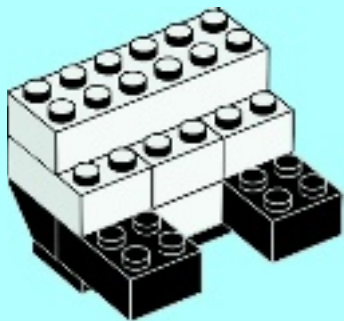

2x

6

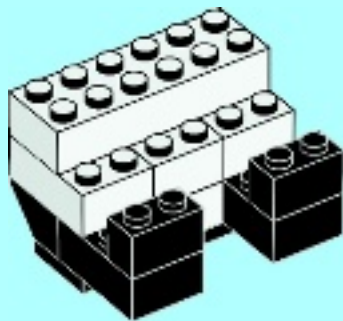



1x



2x

7

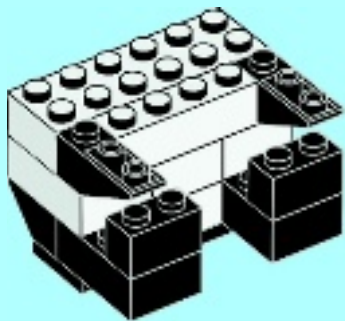

2x



2x

8

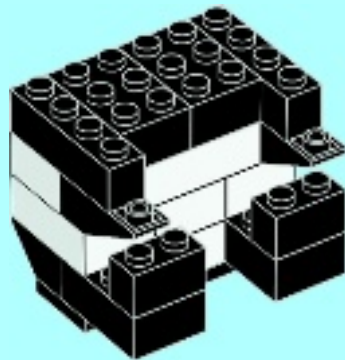



1x



1x



3x



2x

# 9

1



2

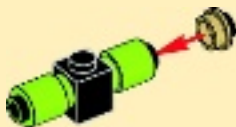

3

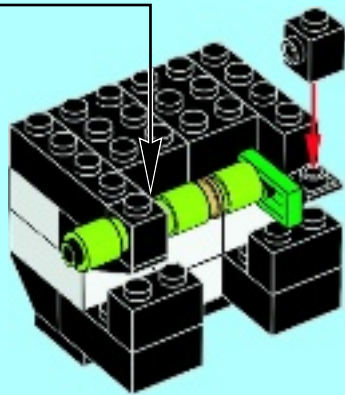



1x

**1**



1x



1x

**2**

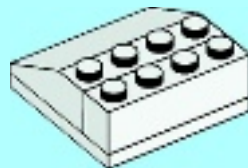





2x



1x

3

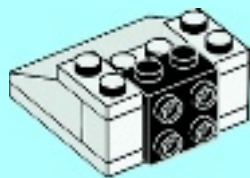

1x



2x

4

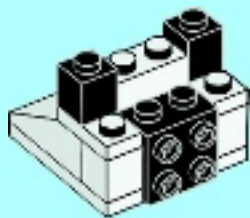

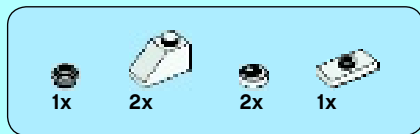

5

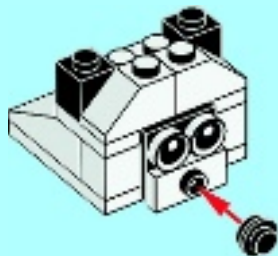

10

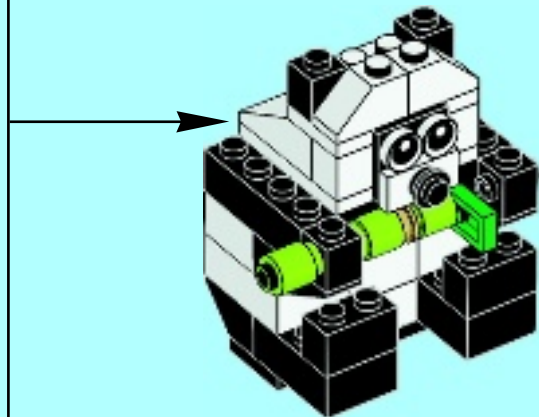

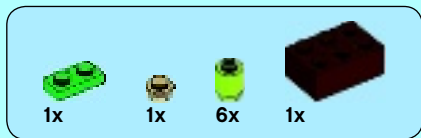

# 11

1



2



3



4

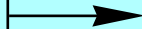



Find more building instructions online  
visitors find more building instructions online  
trouve d'autres instructions de construction disponibles en ligne  
maie instruções de construção disponíveis online en Internet  
Online még több építési útmutatót találasz

[LEGO.com/Creative](http://LEGO.com/Creative) 



# JUNIORS



10668



10667



10674



10673





# club™











































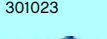







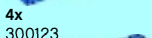





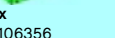













## Free\*! Gratuit !

\* Paid subscription in Australia and New Zealand.  
Abonnement payant en Australie et Nouvelle-Zélande.



[LEGO.com/club](http://LEGO.com/club)



 4x 300523	 8x 4121936	 2x 366024	 4x 366524	 1x 4288212	 2x 4504382	 3x 4535739	 4x 4107736
 12x 300423	 4x 366023	 2x 303924	 2x 4247771	 1x 6022160	 4x 4121966	 2x 6048855	 6x 300328
 4x 300323	 3x 614123	 4x 300324	 3x 614124	 2x 614326	 3x 366026	 4x 4568644	 3x 4109674
 2x 301023	 1x 4514398	 2x 362224	 2x 302324	 4x 303726	 2x 428726	 2x 292626	 2x 4112838
 4x 300123	 3x 4504381	 2x 300224	 2x 302224	 4x 300226	 2x 4251161	 3x 614126	 3x 4106356
 1x 300823	 4x 300524	 2x 301024	 2x 371024	 2x 301026	 2x 302326	 4x 302328	 1x 4181135
 1x 302023	 6x 300424	 3x 300124	 3x 4214559	 1x 300926	 2x 302226	 4x 302328	 2x 4541526
 1x 302023	 1x 4569078	 3x 300124	 5x 300526	 1x 4129572	 3x 302026	 2x 4142717	 2x 4541526
 2x 4107437	 1x 4570442	 1x 4181143	 8x 300426	 1x 4129572	 2x 379526	 2x 303928	 6x 4609925





4x  
4170457



2x  
306201



2x  
614301



1x  
4655446



4x  
4121932



2x  
366001



1x  
4181142

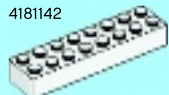

1x  
6033776

46



3x  
4626882



2x  
300501



4x  
300401



2x  
300301



6x  
362201



4x  
300201



6x  
301001



2x  
300101



1x  
300901



3x  
428701



1x  
329701



14x  
6029156



2x  
4224792



2x  
6051511



3x  
302301



2x  
371001



1x  
4243812

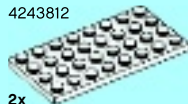

2x  
303501



4x  
4211388



4x  
4211387



2x  
4211428



2x  
4211386



2x  
4211385



1x  
4211392



2x  
4211406



1x  
4211407



4x  
4211389



1x  
4211580



2x  
4211437



2x  
4211488



2x  
4211397



3x  
4161734



4x  
4579260



1x  
6024495



4x  
4218749



4x  
4109995



2x  
4162465



2x  
4159739



8x  
4114319

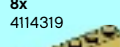

2x  
4112982



2x  
4117070



4x  
4516055



4x  
4159196



3x  
4114322



2x  
4500453



2x  
4155708



1x  
4121921



2x  
4118790



2x  
4114309



2x  
4124067



1x  
6048857



3x  
4517996



4x  
4517993



2x  
4550359

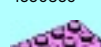

4x  
4520632



3x  
4211150



2x  
4216695



2x  
4211242



6x  
4211149



4x  
4211210



3x  
4216668



5x  
4211225

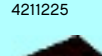

2x  
4211201

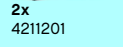

1x  
4211193



2x  
4529242



2x  
4211199



2x  
4211221

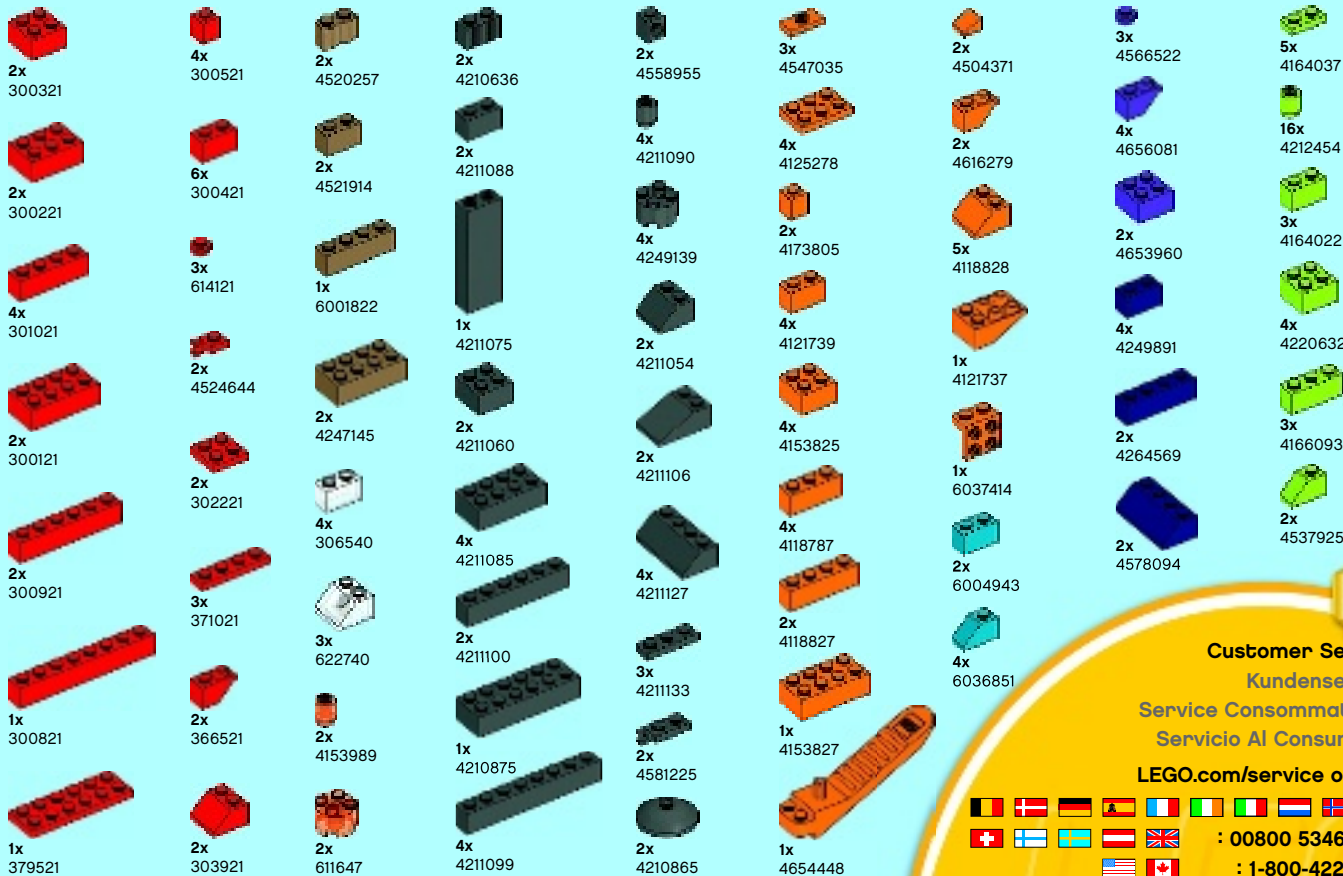

Customer Service

Kundenservice

Service Consommateurs

Servicio Al Consumidor

LEGO.com/service or dial



: 00800 5346 5555

: 1-800-422-5346



# WIN!

Go to [LEGO.com/productfeedback](http://LEGO.com/productfeedback) to fill out a survey for a chance to win a cool LEGO® Product.

No purchase necessary.  
Open to all residents where not prohibited.



## LEGO.com/productfeedback

### GEWINNE!

Nimm an der Umfrage auf [LEGO.com/productfeedback](http://LEGO.com/productfeedback) teil und hab die Chance ein cooles LEGO® Produkt zu gewinnen!

Die Teilnahme am Gewinnspiel führt zu keinerlei Kaufverpflichtungen. Teilnahme in allen nicht ausgeschlossenen Ländern möglich.

 [LEGO.com](http://LEGO.com)

6072727

### WIN!

Ga naar [LEGO.com/productfeedback](http://LEGO.com/productfeedback), vul een enquêteformulier in en maak kans op een cool LEGO® product.

Geen aankoopverplichting.  
Iedereen mag deelnemen, uitgezonderd ingezetenden van landen waar een enquêteverbod geldt.

### GAGNE!

Visite [LEGO.com/productfeedback](http://LEGO.com/productfeedback) pour répondre à un questionnaire et avoir une chance de gagner un produit LEGO® très cool!

Aucune obligation d'achat.  
Ouvert à tous les résidents des pays autorisés.

### 当てよう!

[LEGO.com/productfeedback](http://LEGO.com/productfeedback) にアクセスして、アンケートにご記入ください。当選者にはレゴ®製品を差し上げます。

お買い上げの必要はありません。  
禁止されていない限り、すべての皆様にご利用いただけます。