



40450



Booklet available in English on  
Heft in deutscher Sprache erhältlich auf  
Livret disponible en français sur  
Libretto disponibile in Italiano su  
Folleto disponible en español en  
如需中文版手册, 请访问

[LEGO.com/service/buildinginstructions](http://LEGO.com/service/buildinginstructions)





## AMELIA EARHART TRIBUTE

From her childhood, Amelia Earhart was pushing the boundaries and expectations of being a girl in the early 20th century. Climbing trees, hunting rats and keeping a scrap book of her female role models, succeeding in fields like film direction, law, advertising, management and mechanical engineering – at that time all considered male oriented fields – were all things characterising Amelia. But Amelia followed her heart, and knew she was cut out to do differently.

On 28 December 1920, pilot Frank Hawks gave her a ride that would forever change her life. *“By the time I had got two*



# 1932



*or three hundred feet off the ground, I knew I had to fly."*

Together with her husband (Amelia Earhart referred to her marriage as a partnership with dual control), Amelia Earhart was secretly planning for the 1932 solo flight cross the Atlantic – an achievement accomplished by no woman before. She took off from Harbor Grace, Newfoundland with the destination of Paris in mind. Strong north winds, icy conditions and mechanical problems plagued the flight and forced her to land in a pasture near Londonderry, Ireland.

Recognised as an amazing achievement at the time, Amelia

Earhart was awarded the Distinguished Flying Cross – the first ever given to a woman. At the ceremony, US Vice President Charles Curtis praised her bravery, saying she displayed *"heroic courage and skill as a navigator at the risk of her life."* Earhart felt the flight proved that men and women were equal in *"jobs requiring intelligence, coordination, speed, coolness, and willpower."*







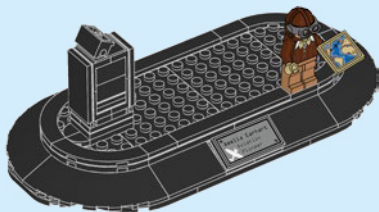
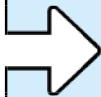
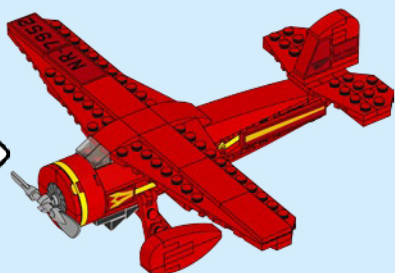
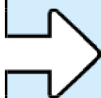

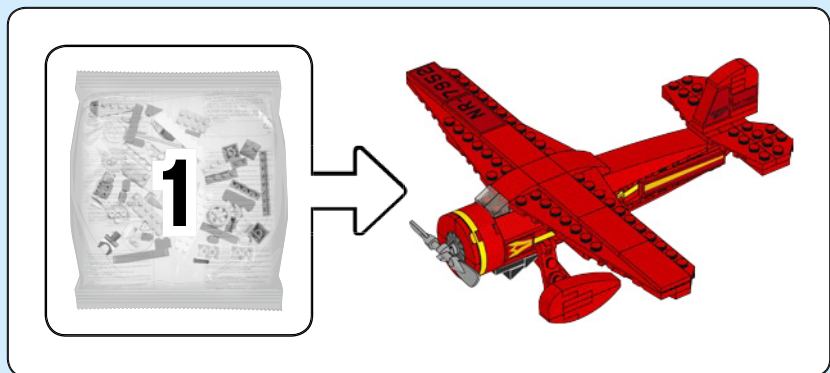

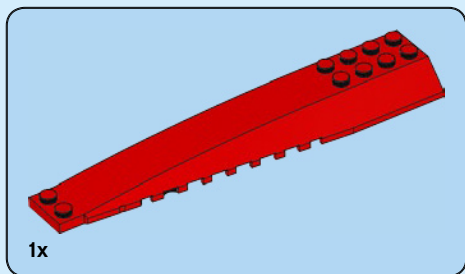

1

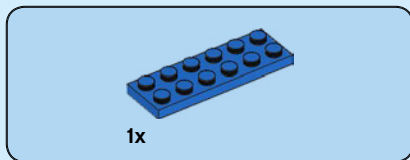
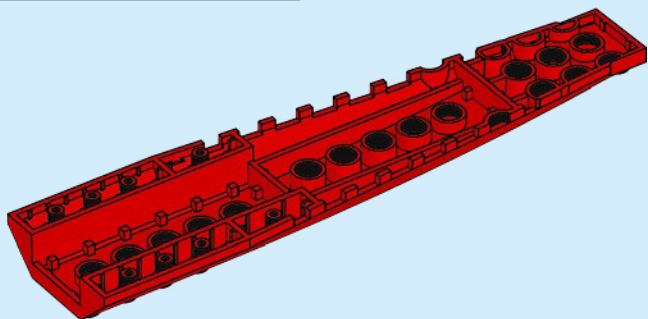

2

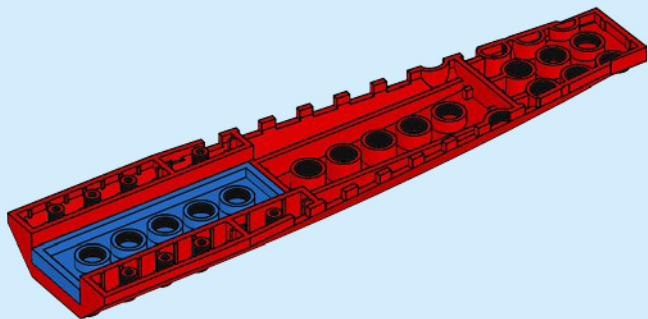

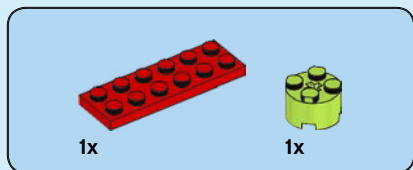

3

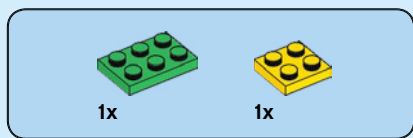
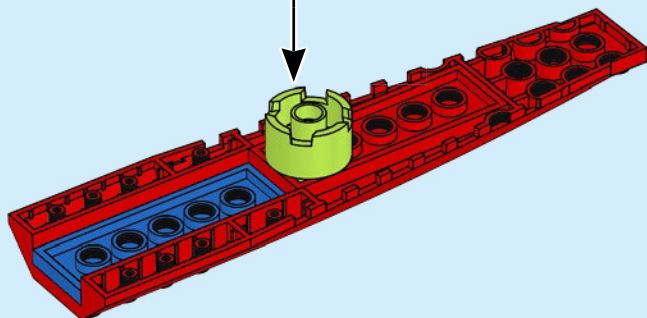
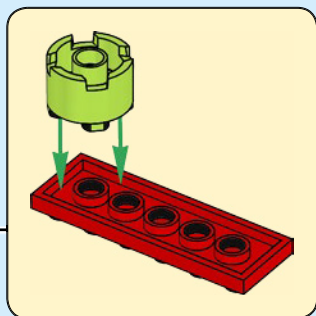

4

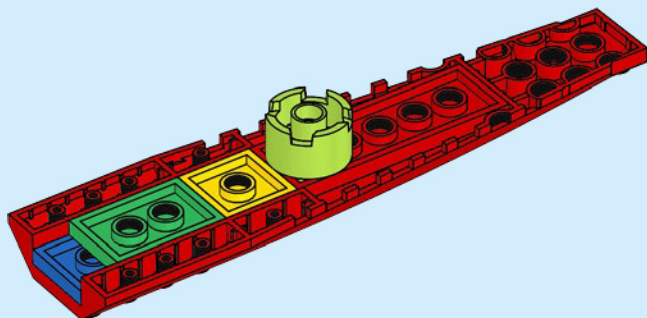

8



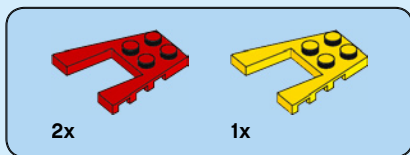

5

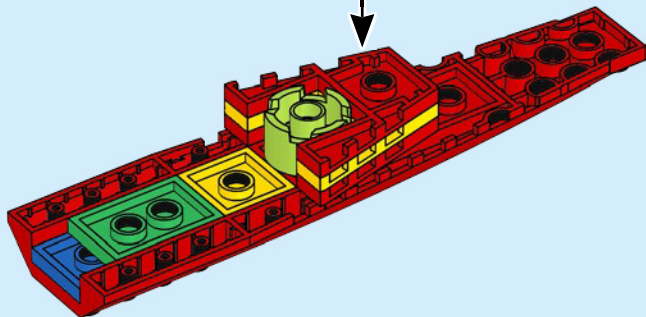
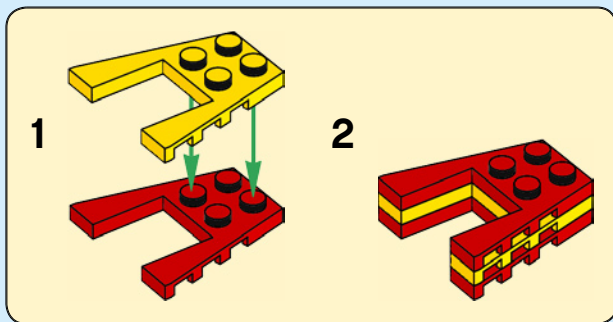

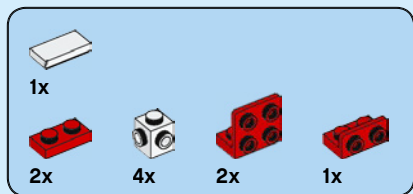

6

1



3

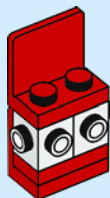

1



2



2



1



2



4

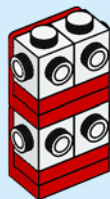

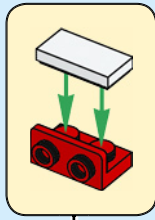

5



6

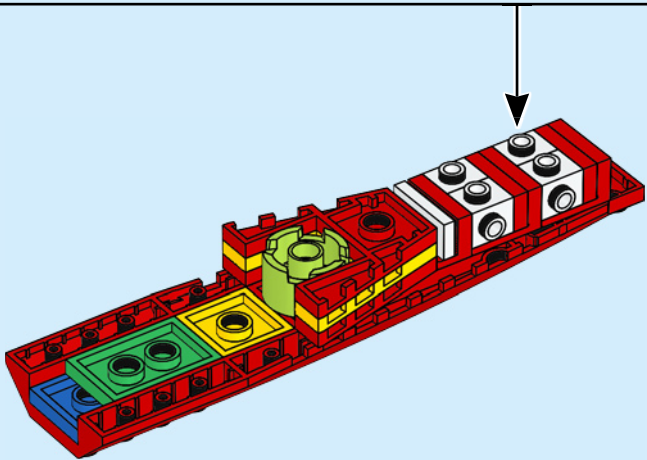
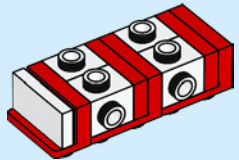

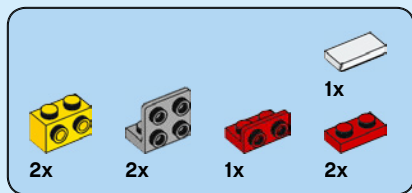

7

1



2

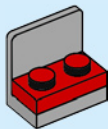

3



4

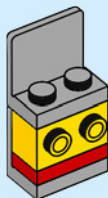

5



6

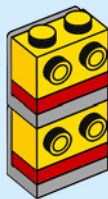





7

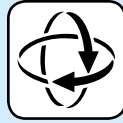
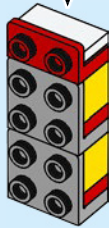
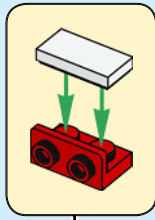

8

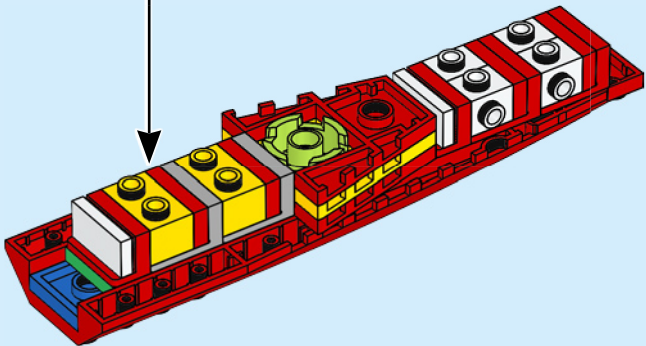
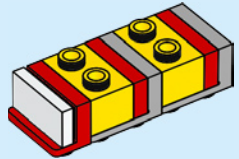

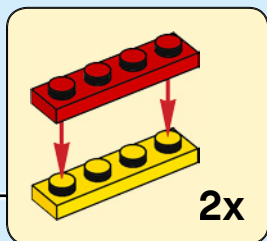

8

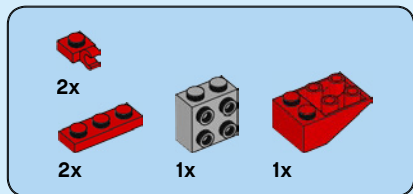
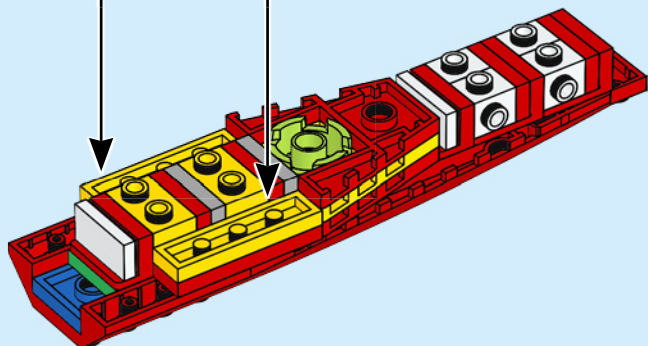

9

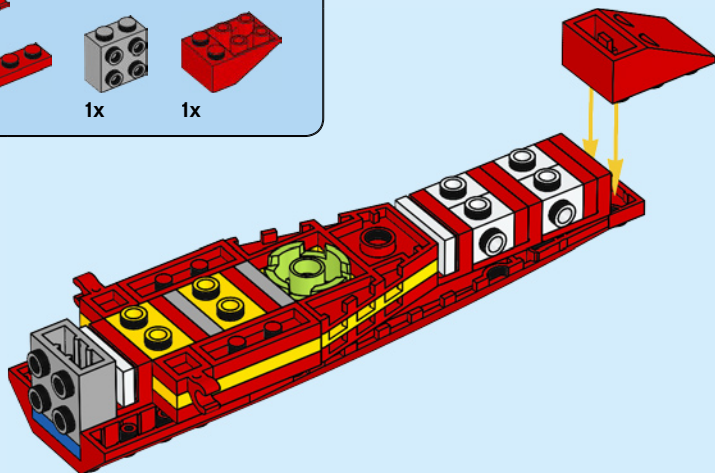



2x

# 10

1

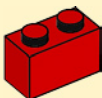

2

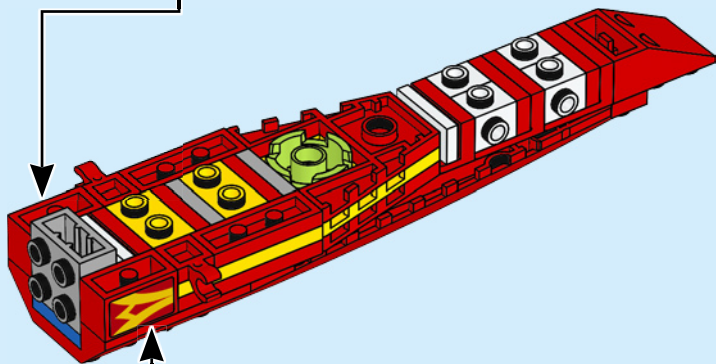

1

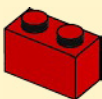

2



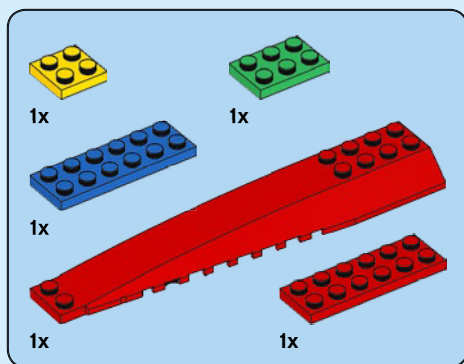

11

1

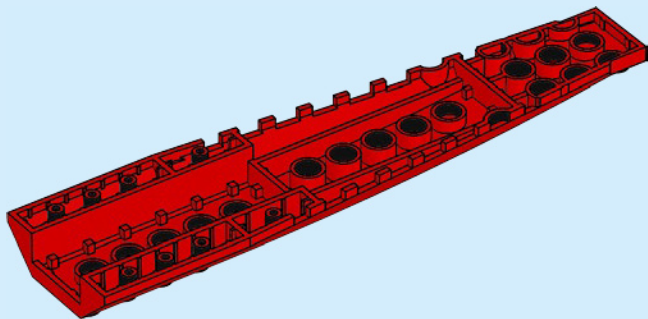

2

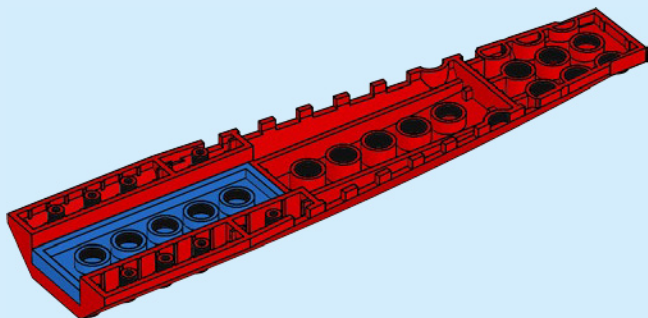



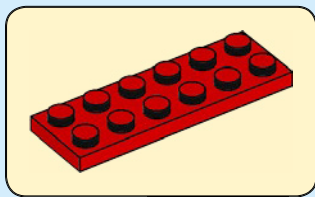

3

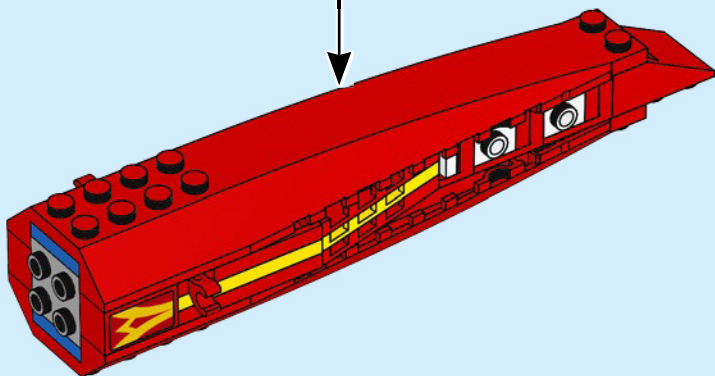
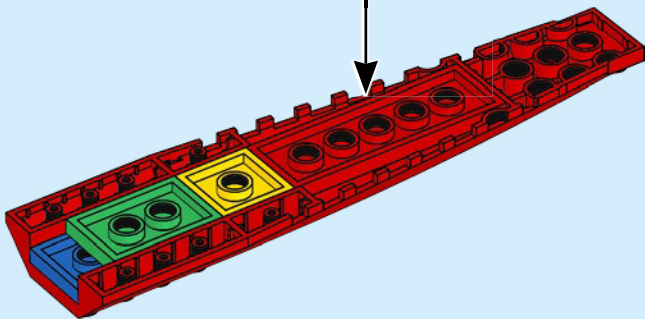

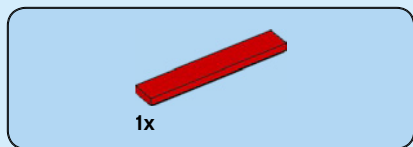

12

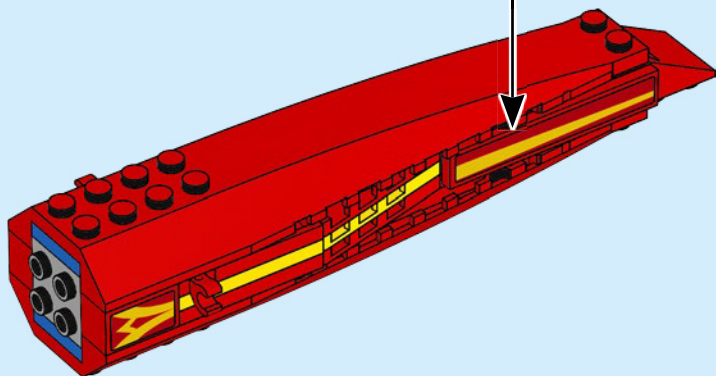
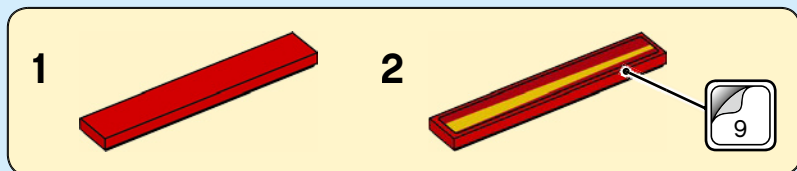

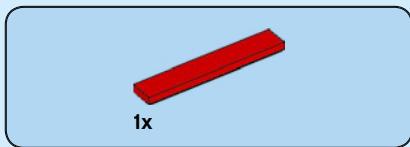

13

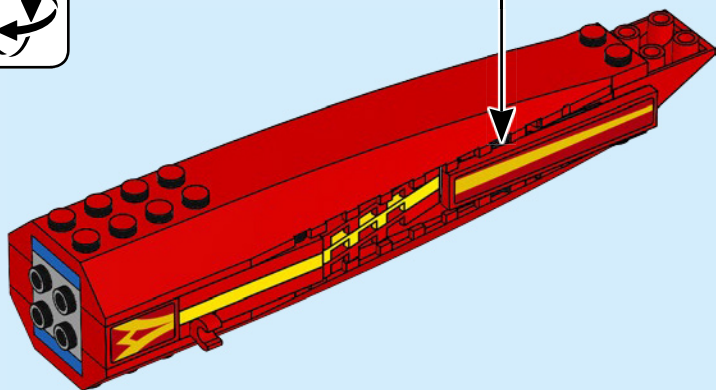
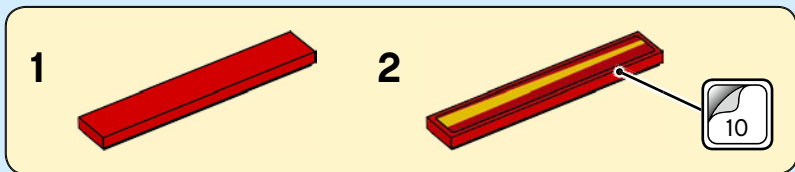

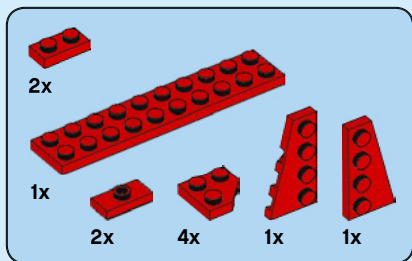

# 14

## 1

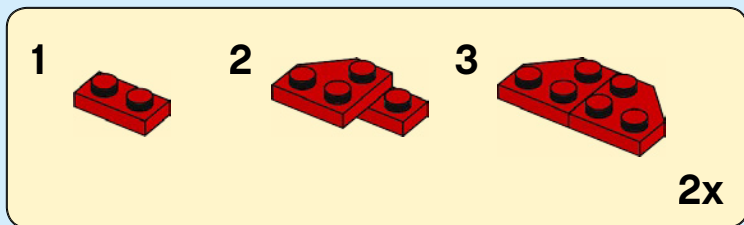
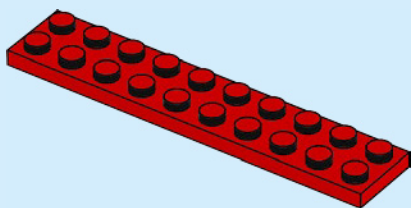

## 2

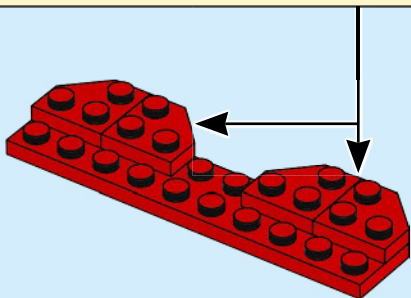

3

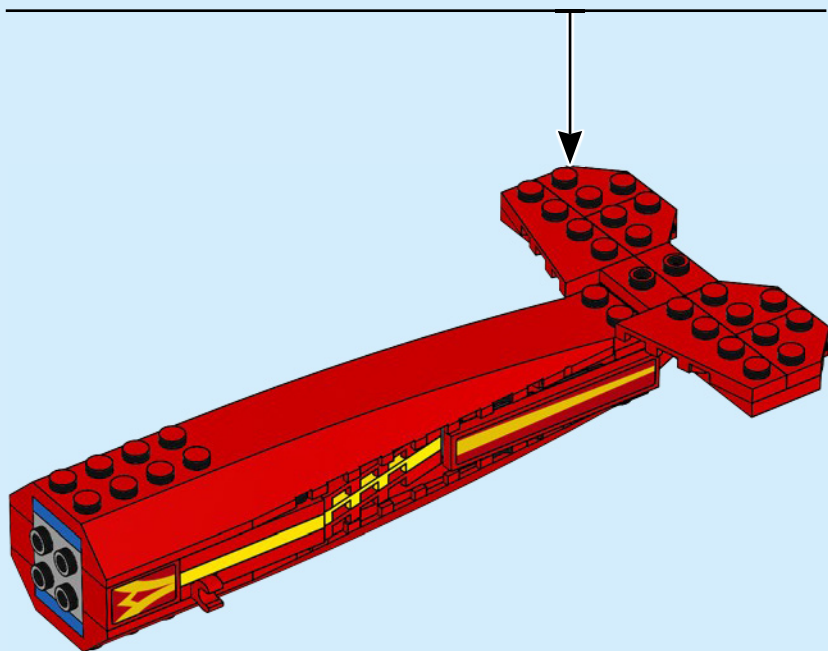
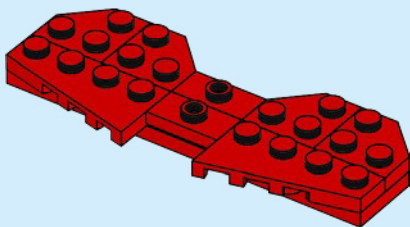



1x

15

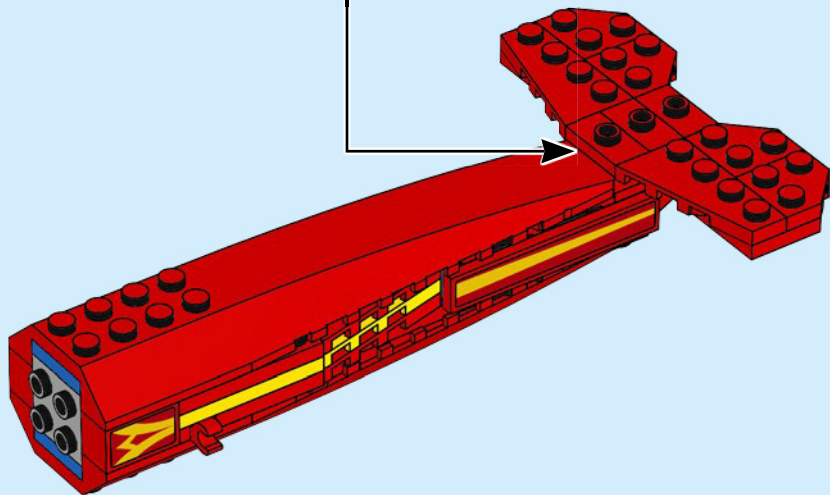

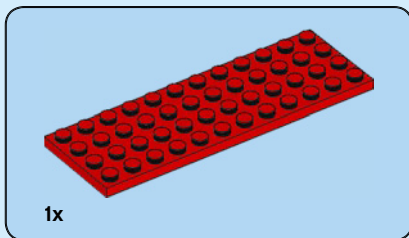
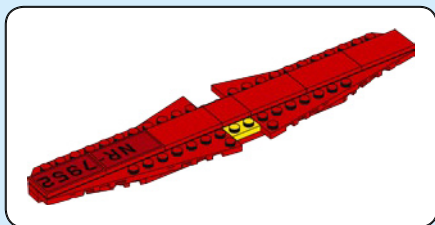

1x

**16**

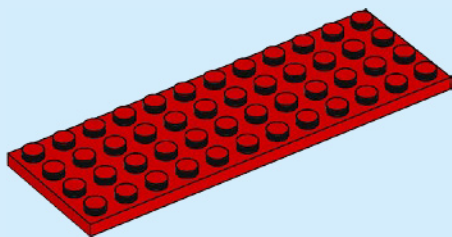

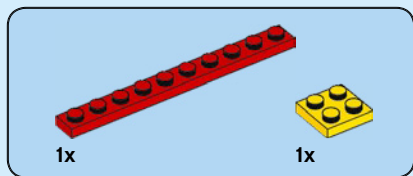

17

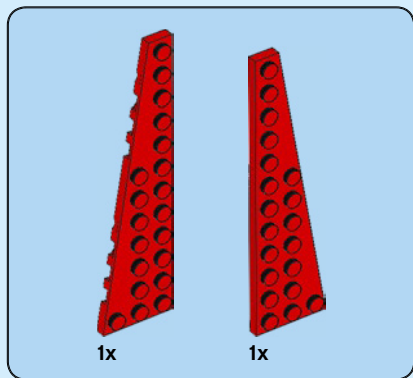
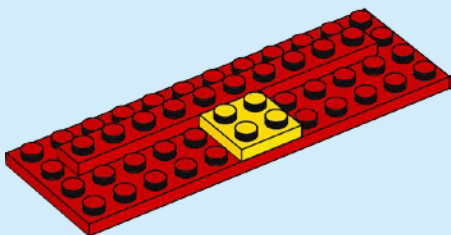

18

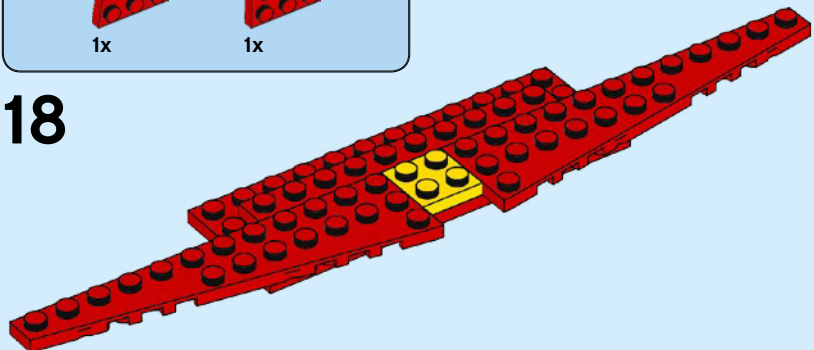



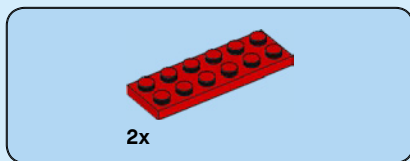

19

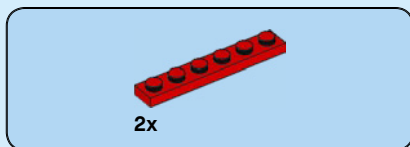
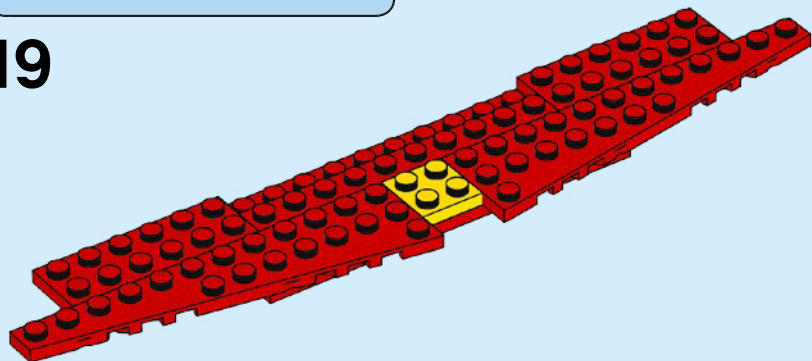

20

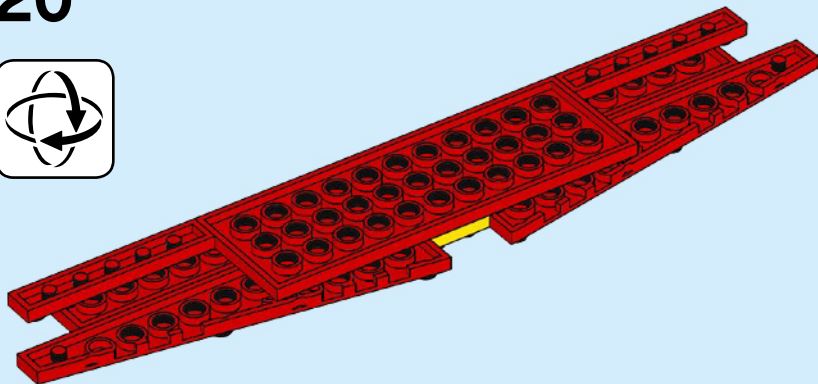
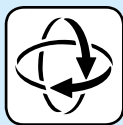



2x

21

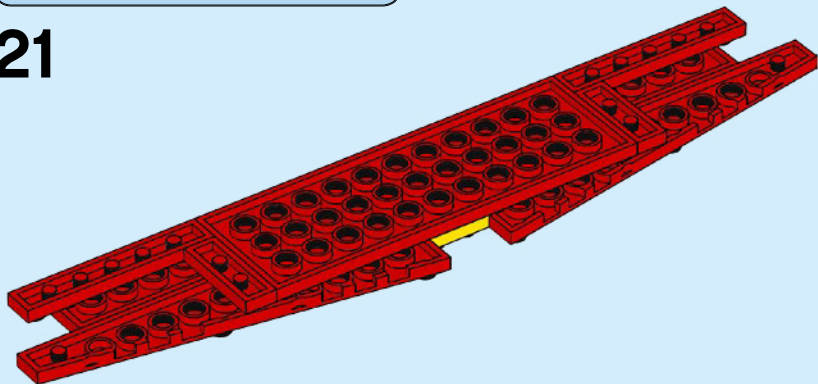

1x

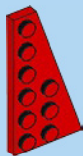

1x

22

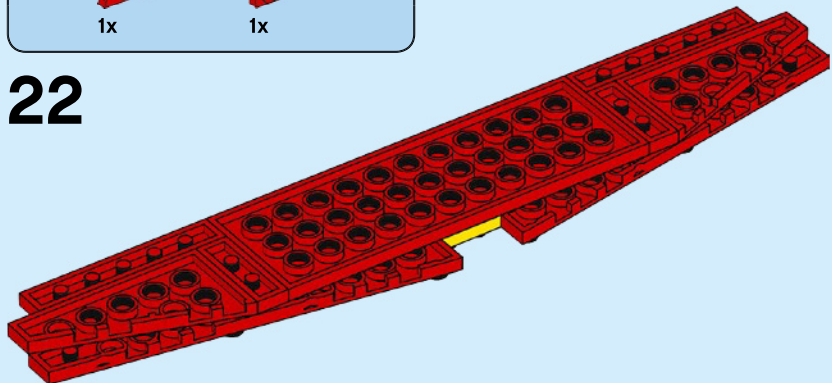

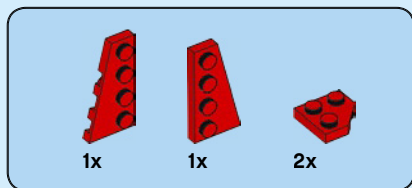

23

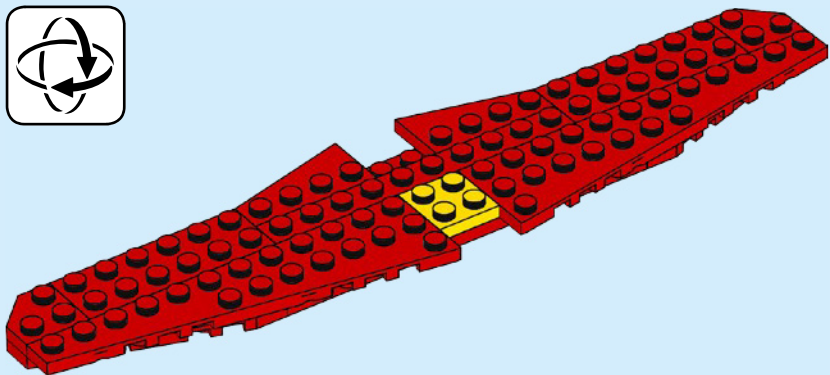
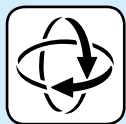

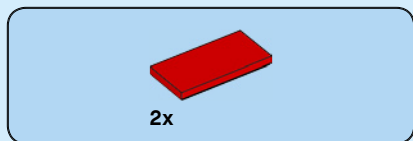

24

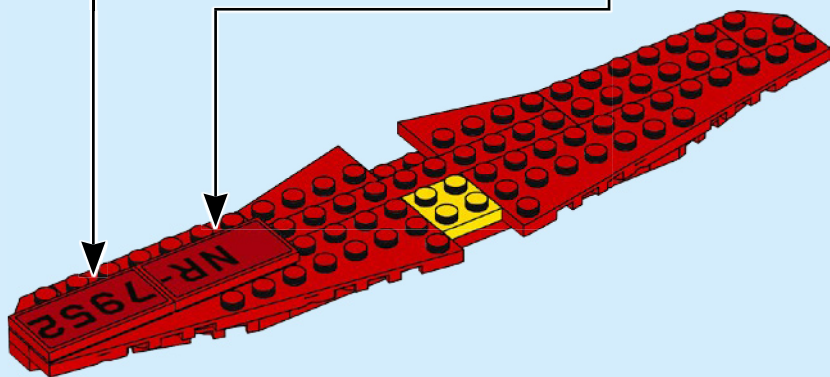
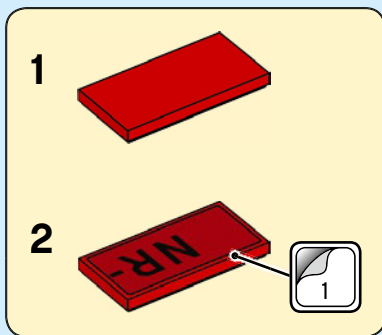
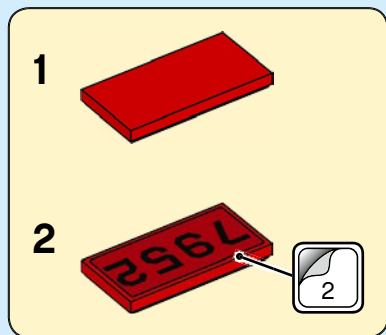

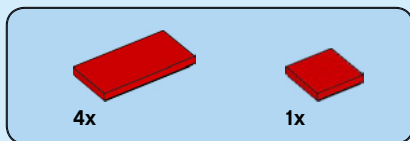

25

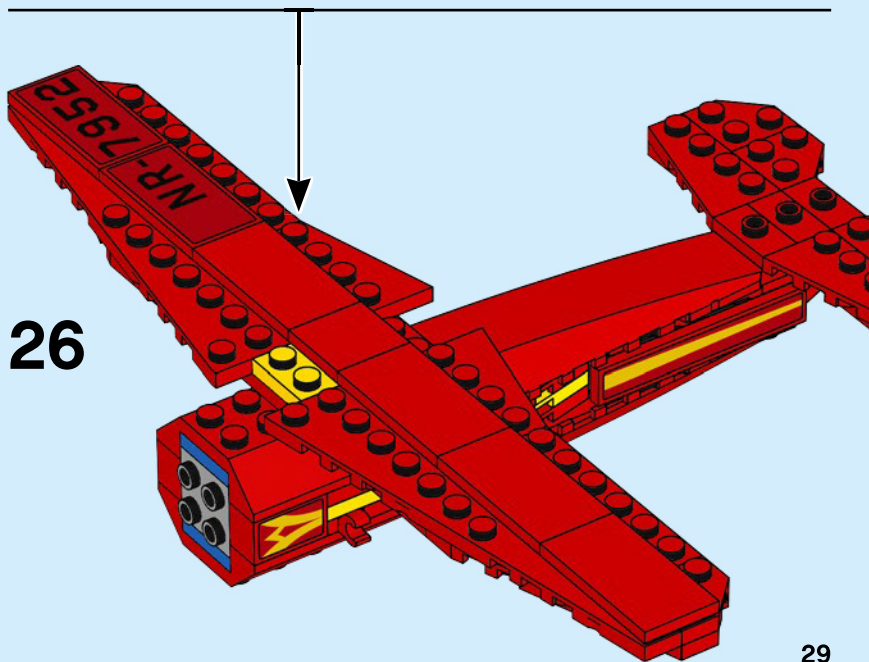
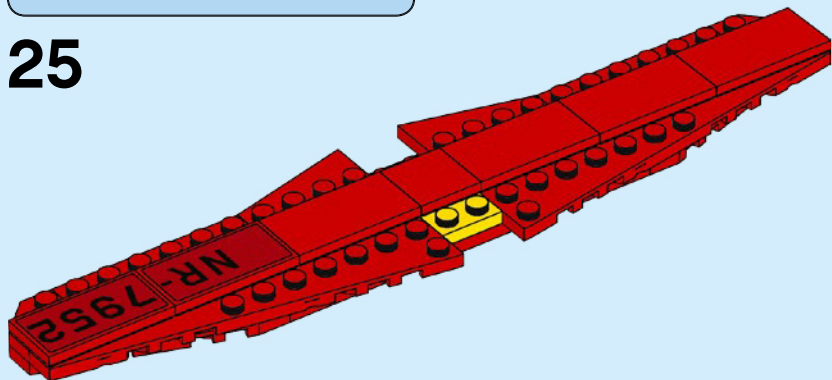



1x



1x



1x

# 27

1



2

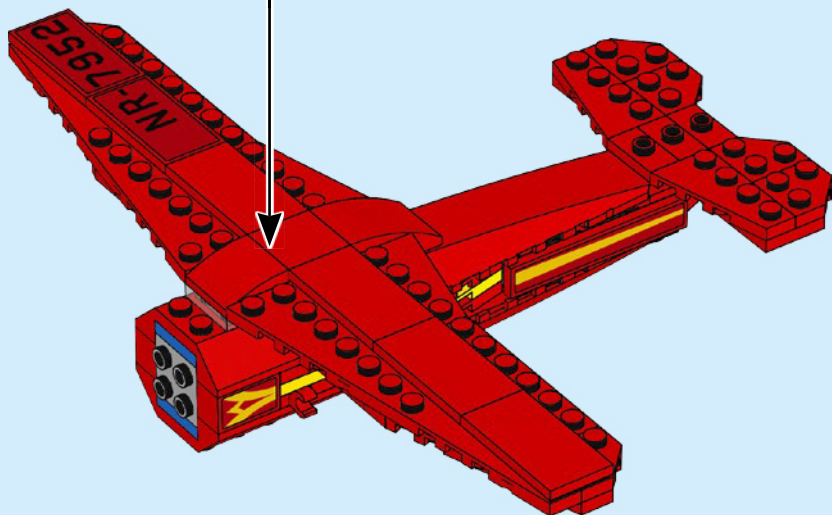
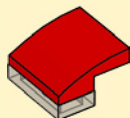



2x

28

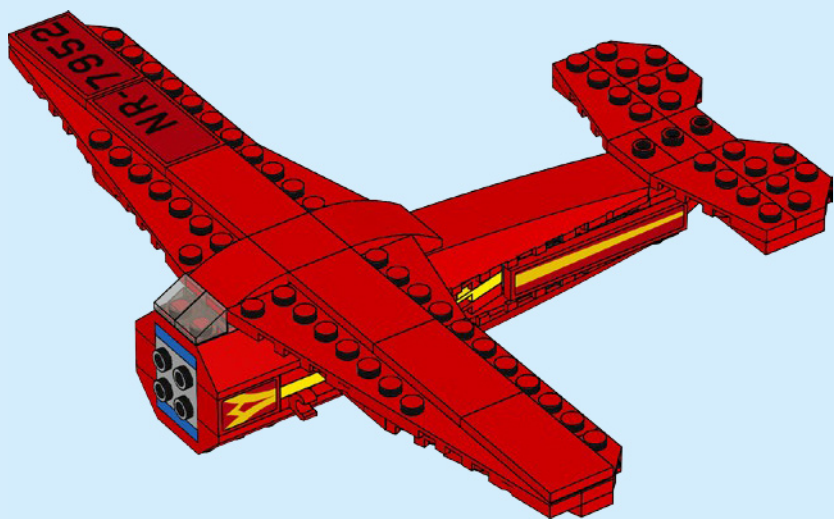



1x



1x

29

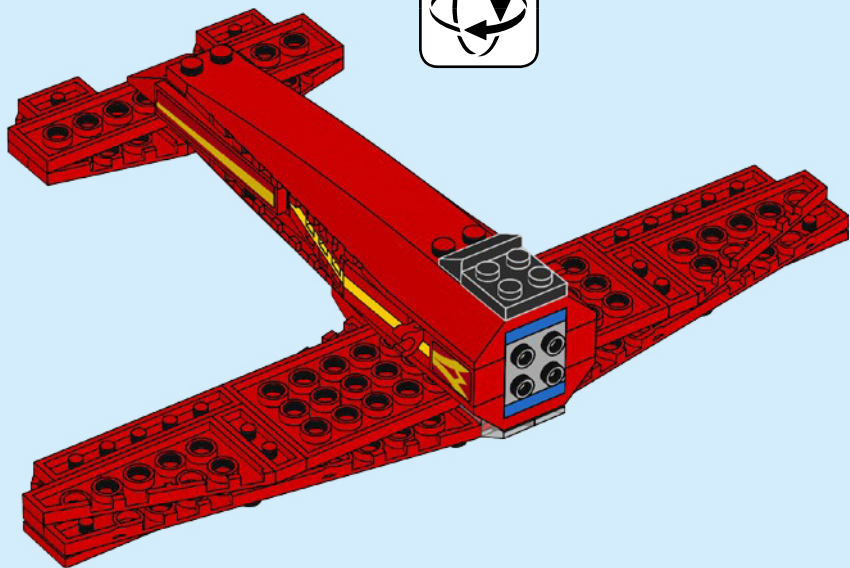





1x



2x

# 30

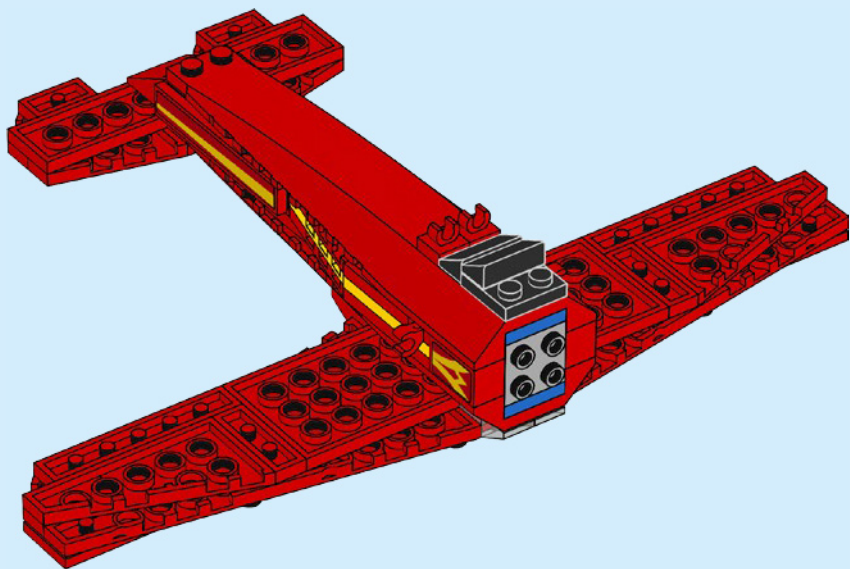

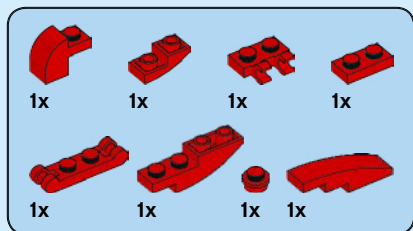

# 31

1

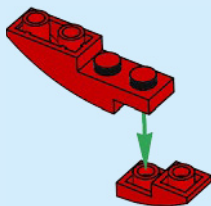

2

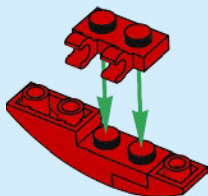

3

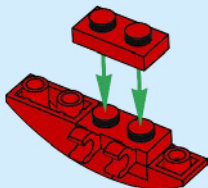

4

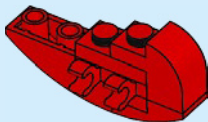

5

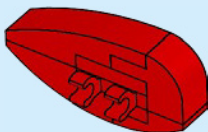

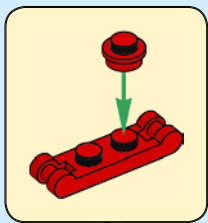

6

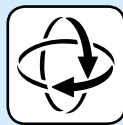
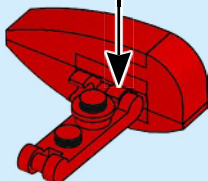

7

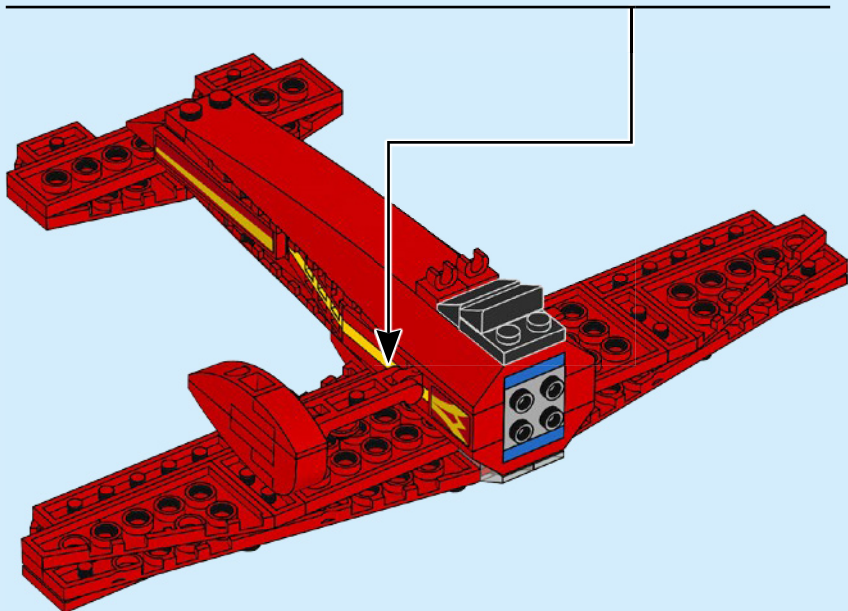
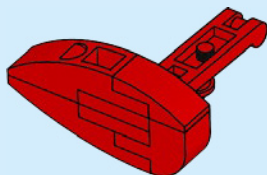

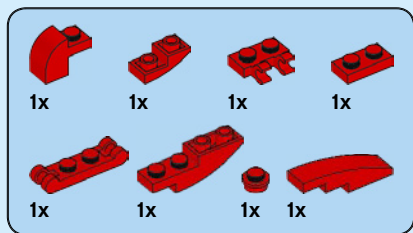

# 32

1

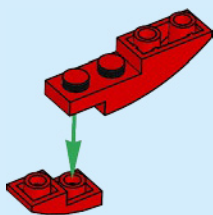

2

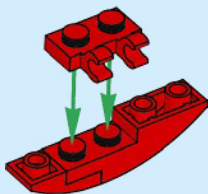

3

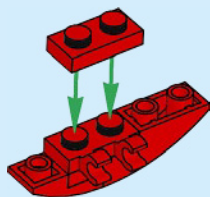

4

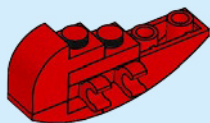

5

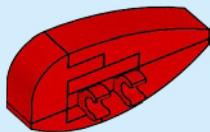

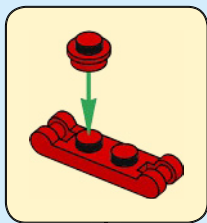

6

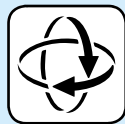
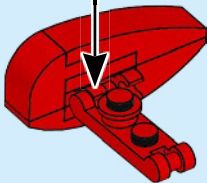

7

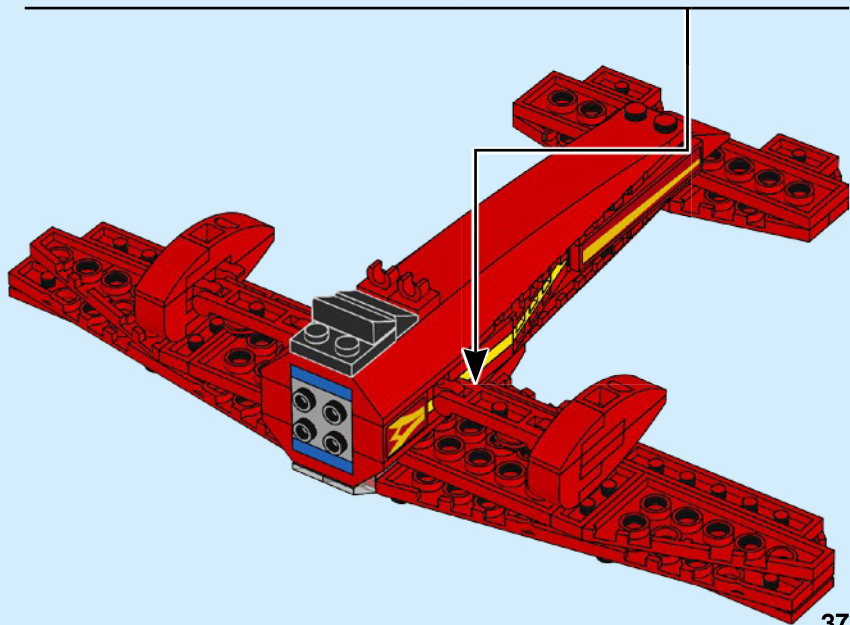
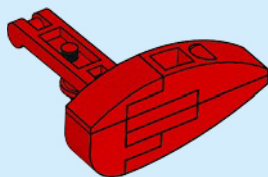



2x

33

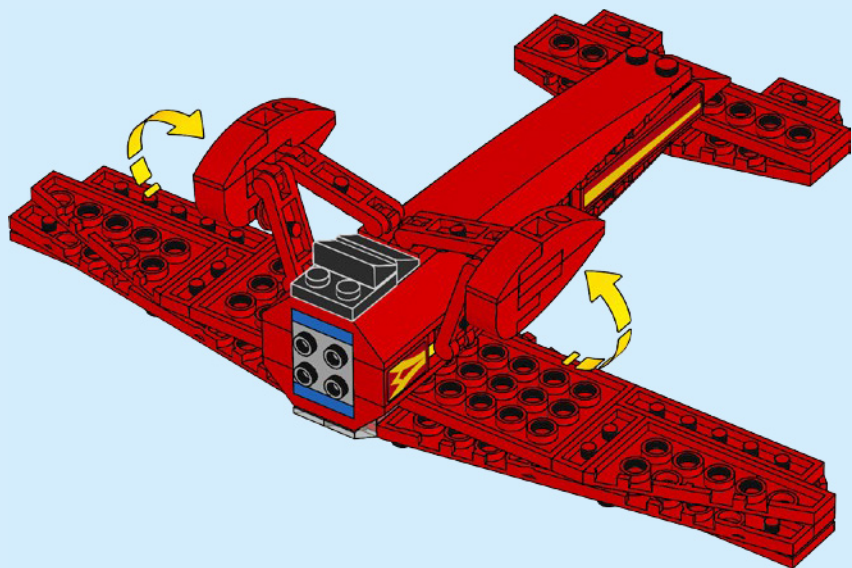

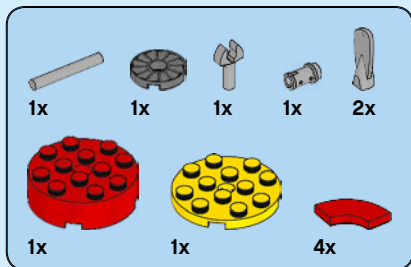

# 34

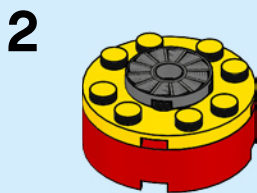
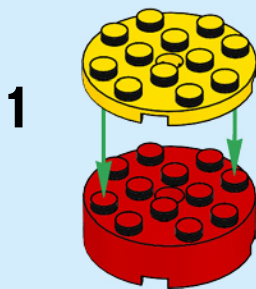

**3**

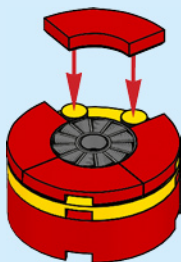

**4**

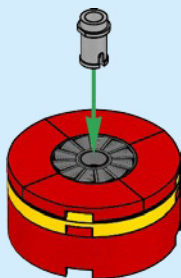

**5**

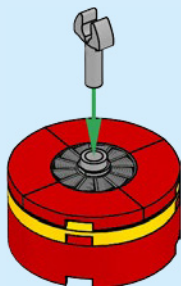



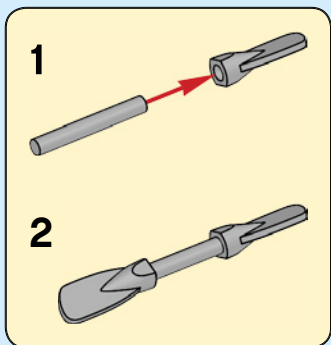

6

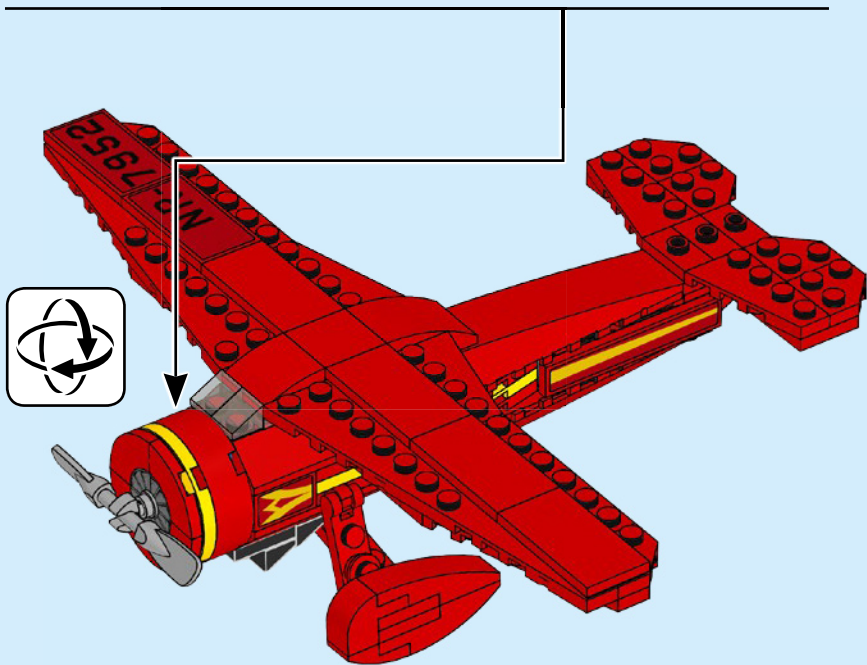
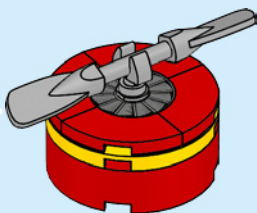

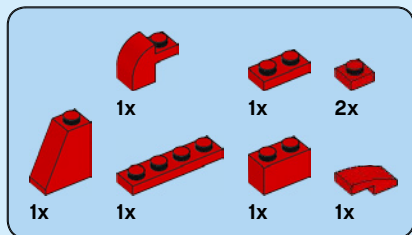

# 35

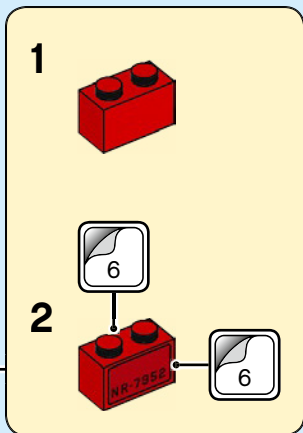
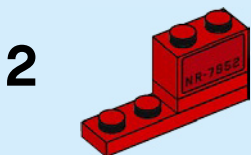
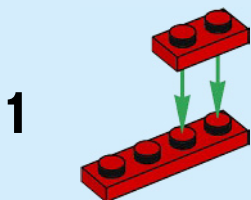

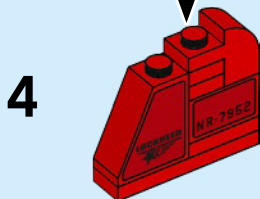
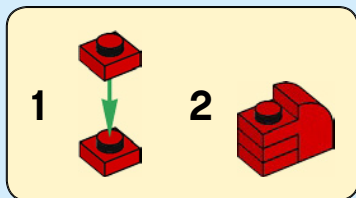
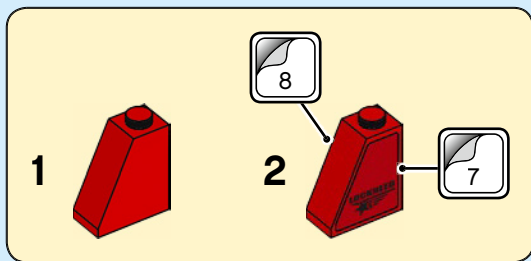

5

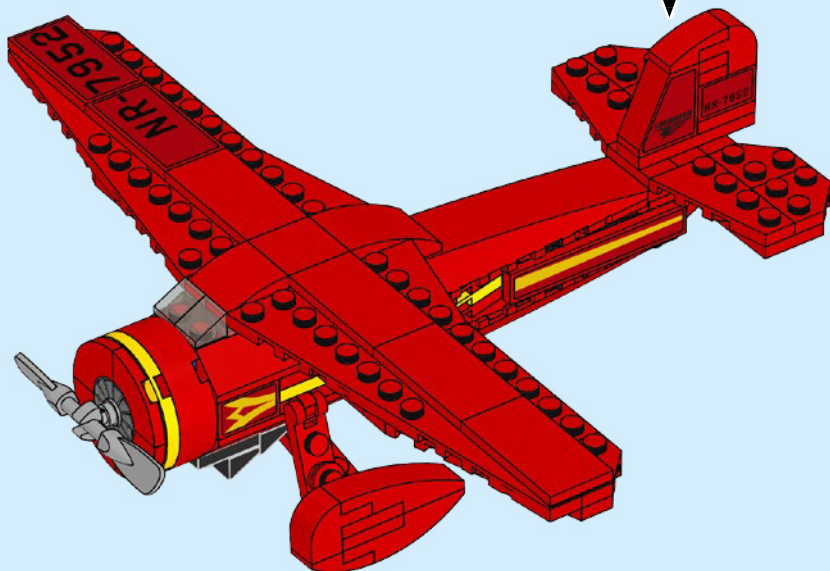
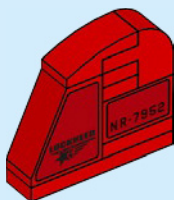

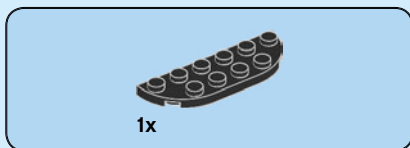
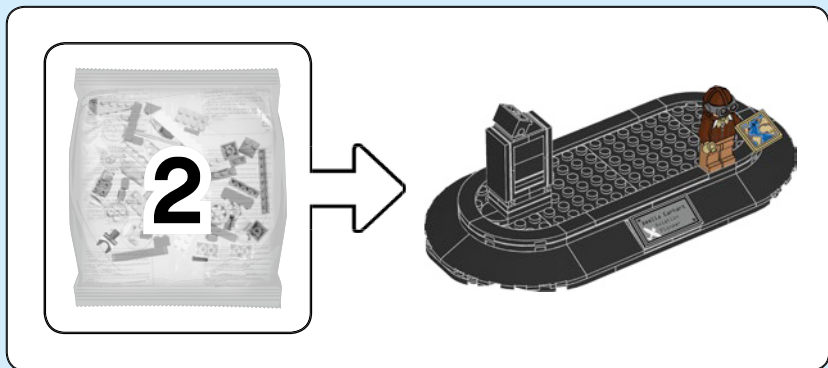

1

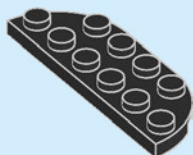

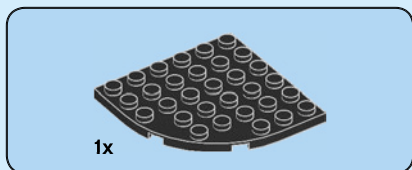

**2**

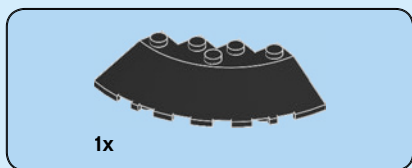
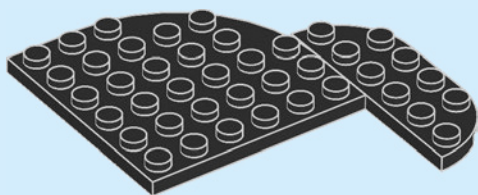

**3**

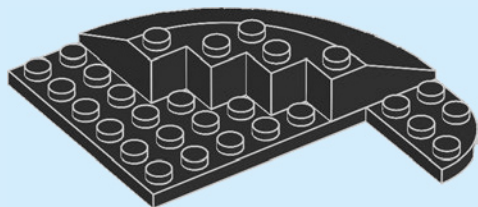

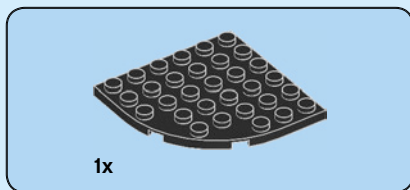

4

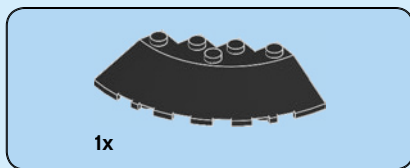
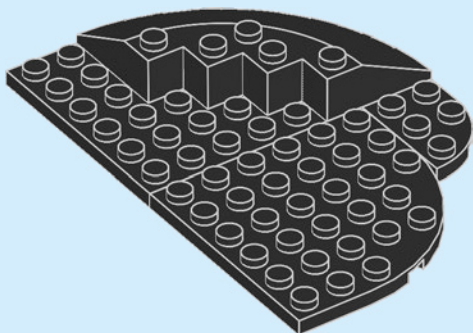

5

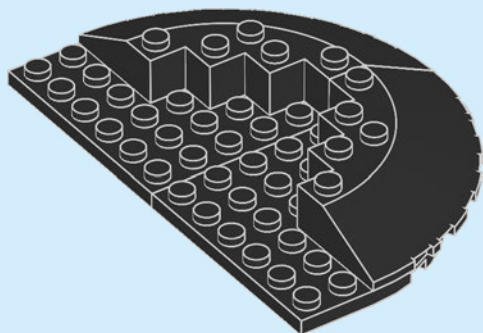

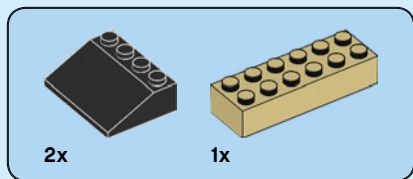

6

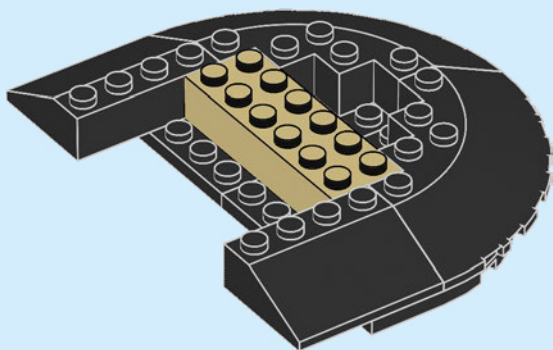



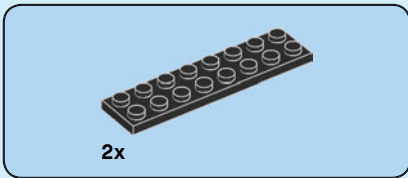

7

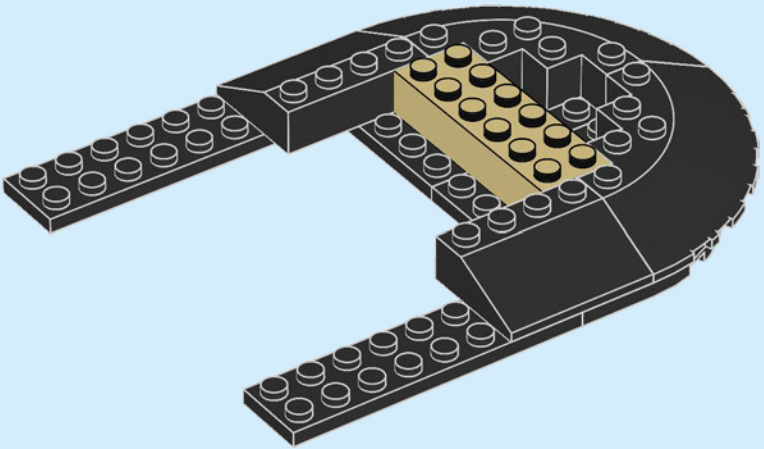



2x

8

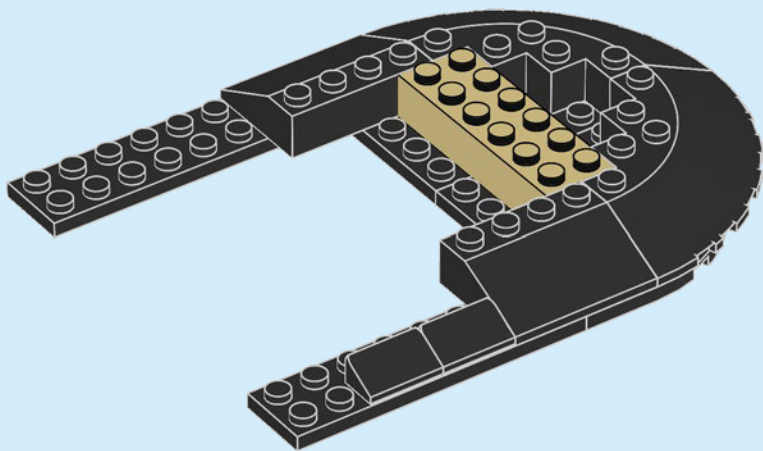



2x



2x

9

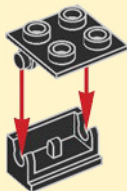

2x

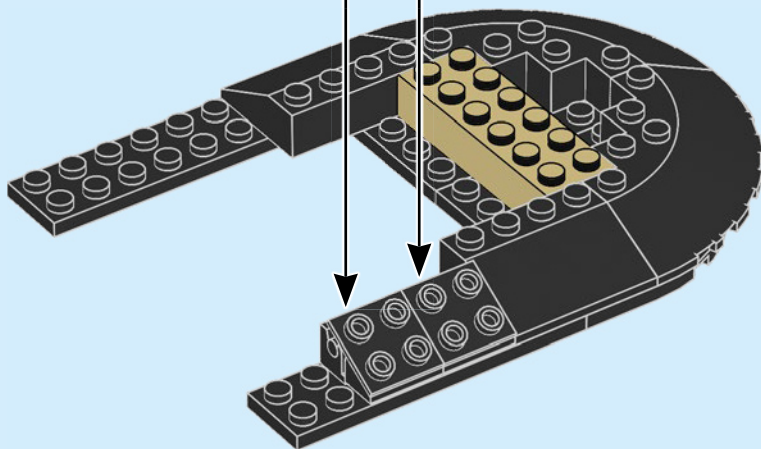

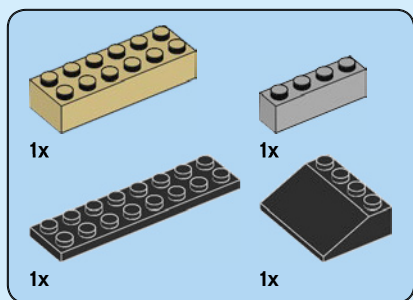

# 10

1

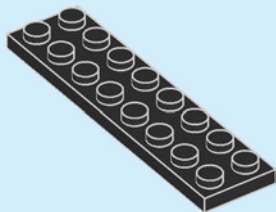

2

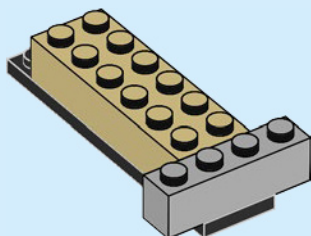

3

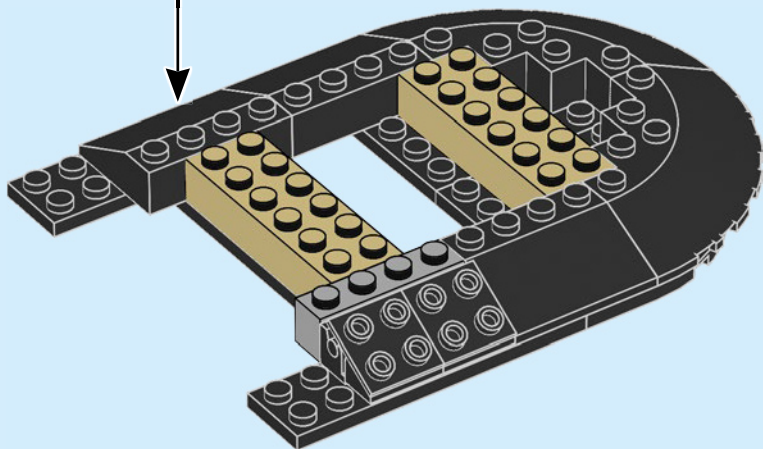
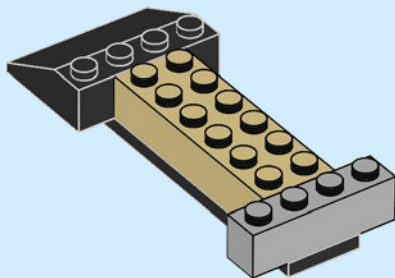

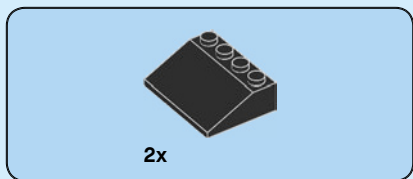

11

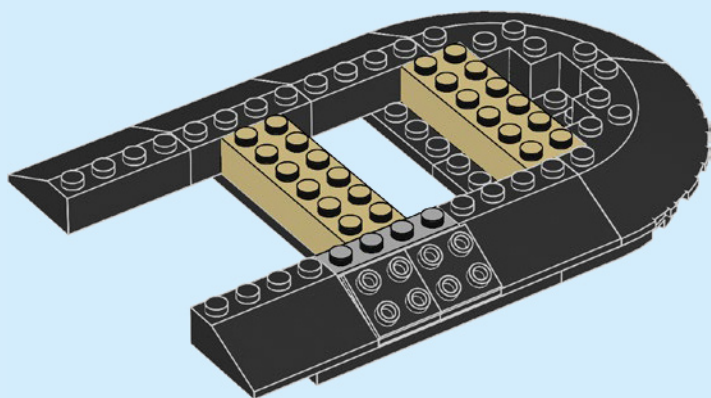

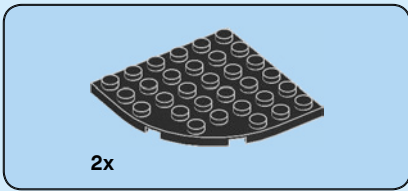

12

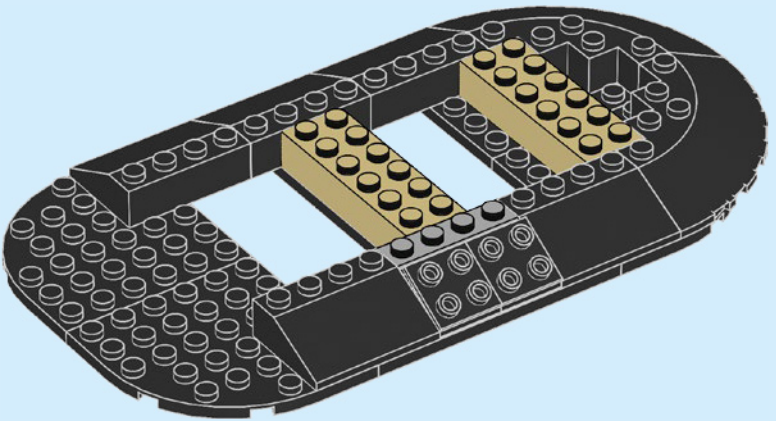

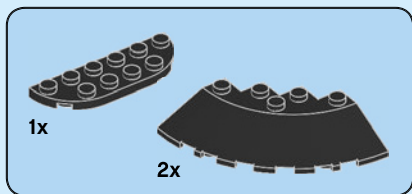

# 13

1



2

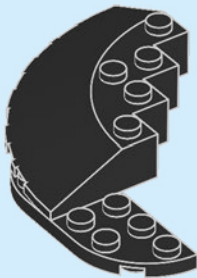



**3**

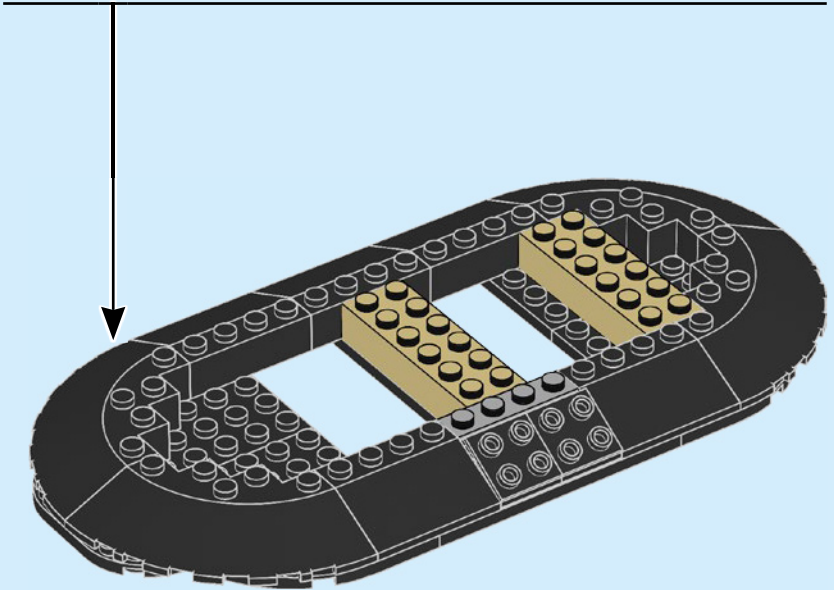
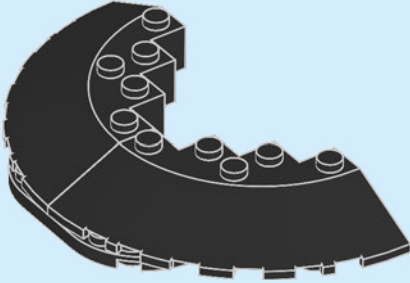

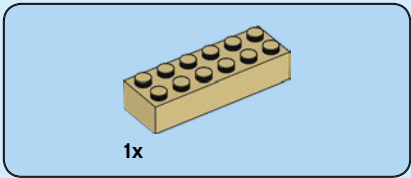

14

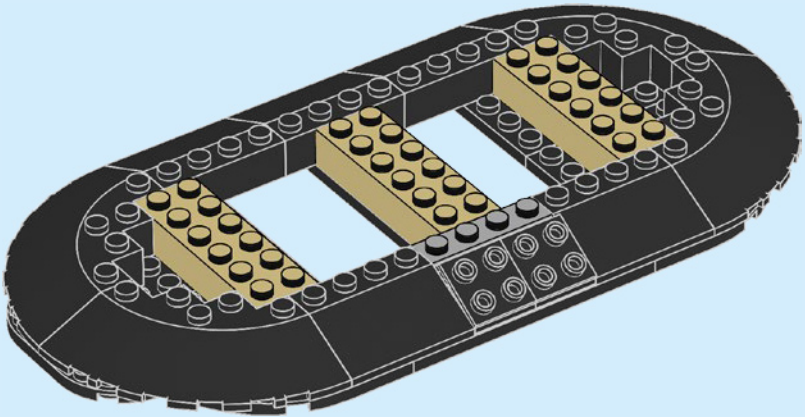

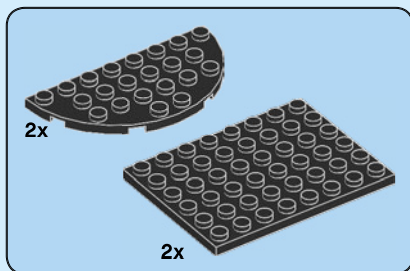

15

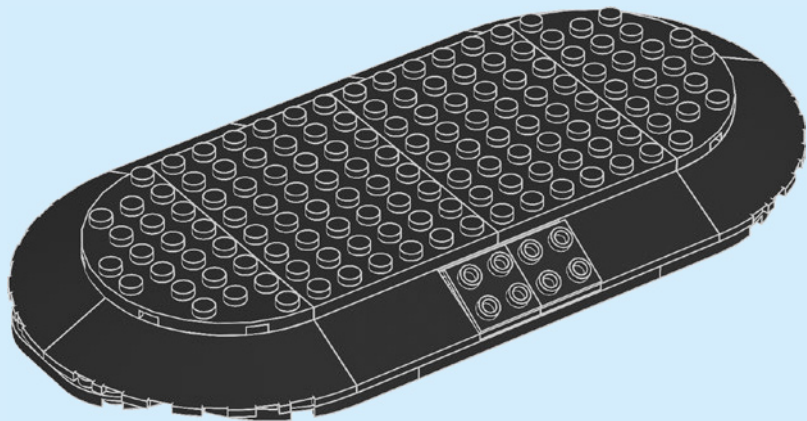

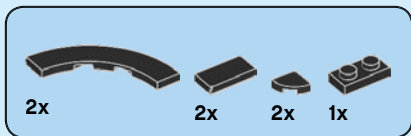

16

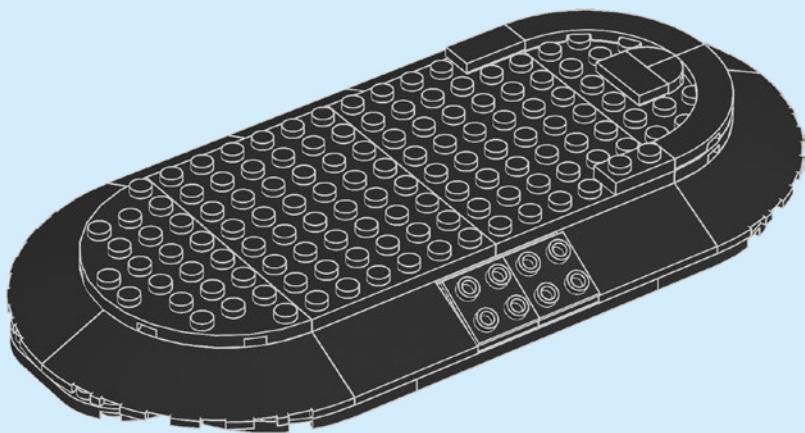

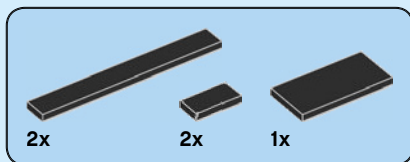

17

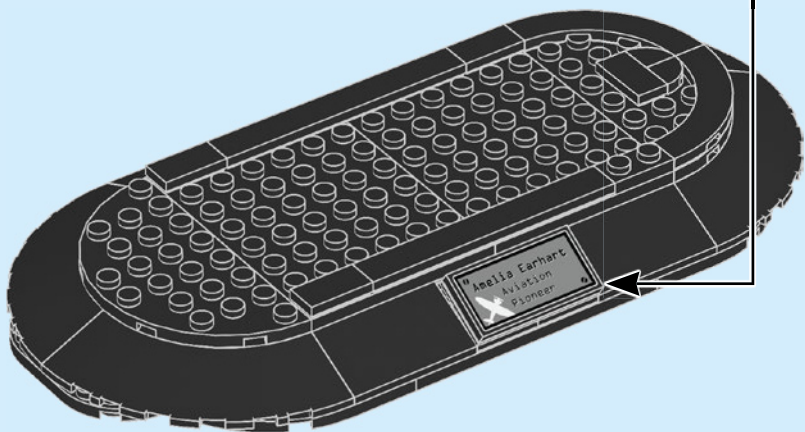
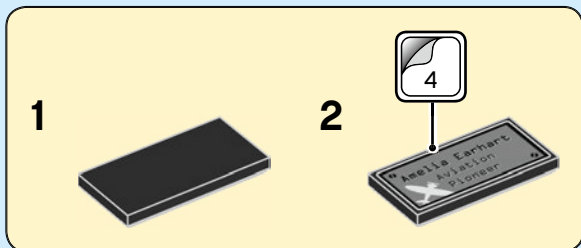

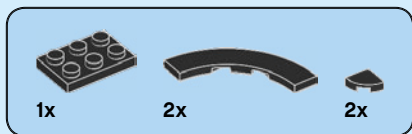

18

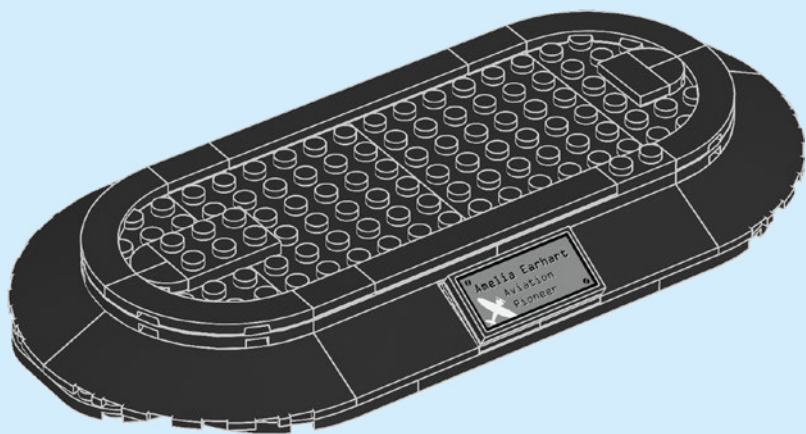



1x

# 19

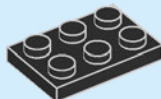

2x

# 20

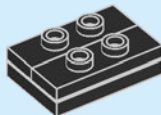



2x

21

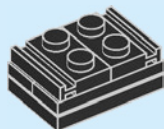

2x

22



1x

23

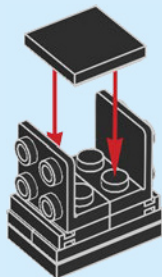



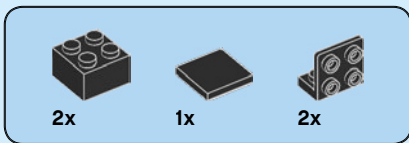

# 24

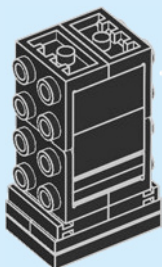
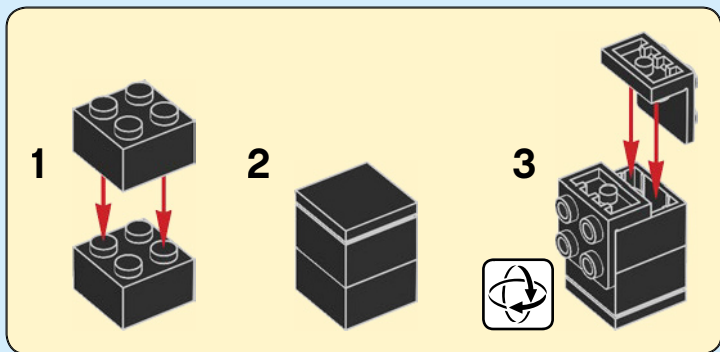

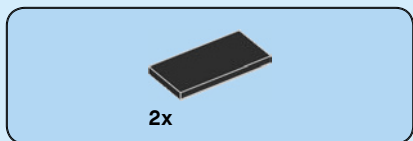

25

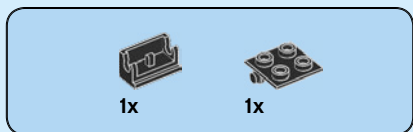
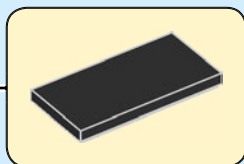
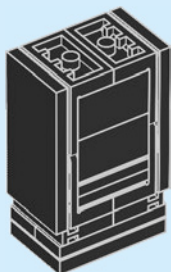

26

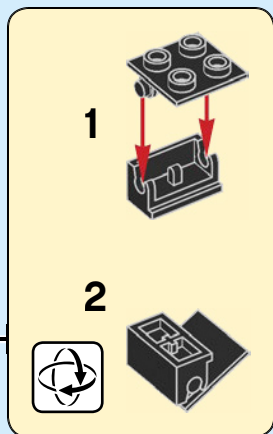

27

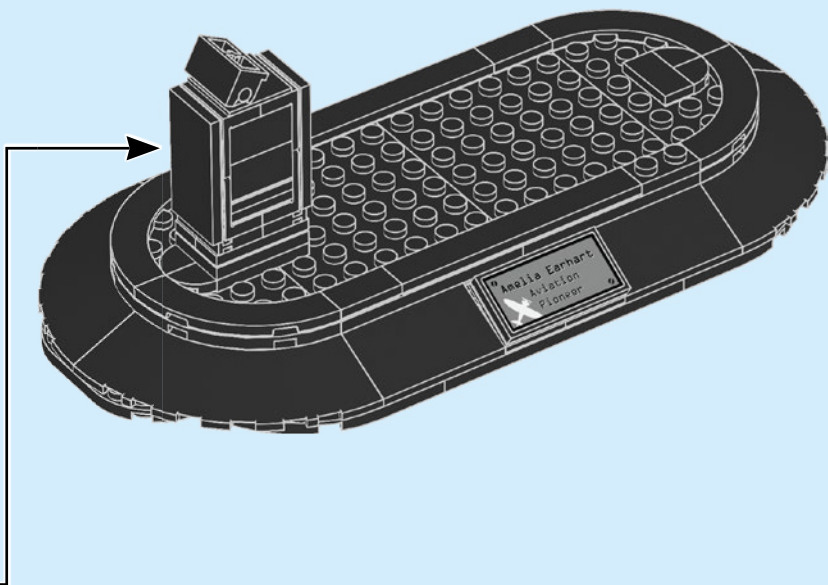

# 28

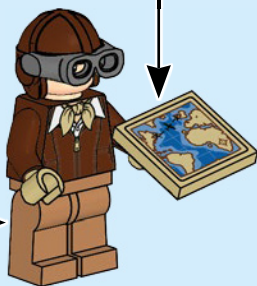
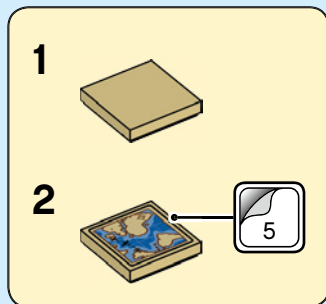
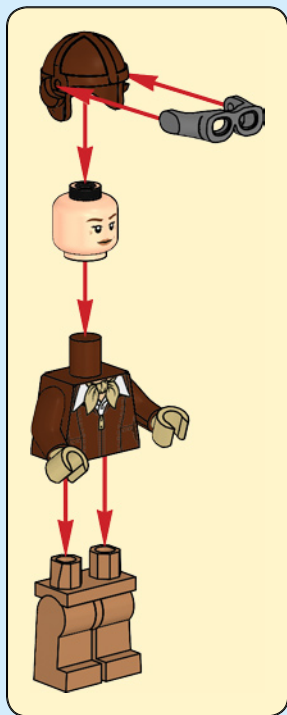

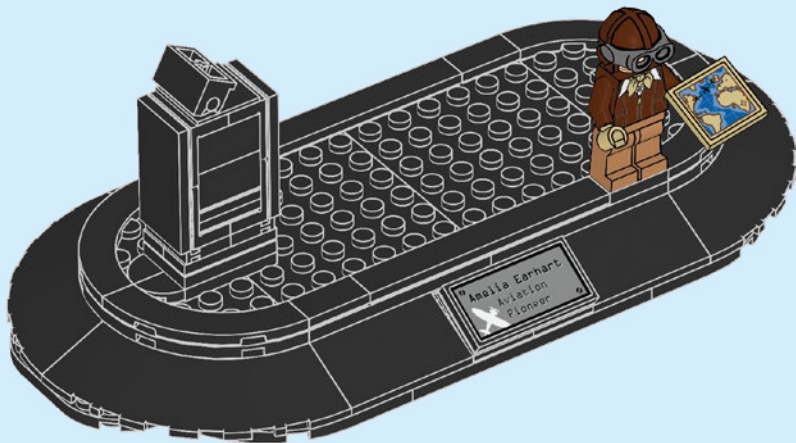

30

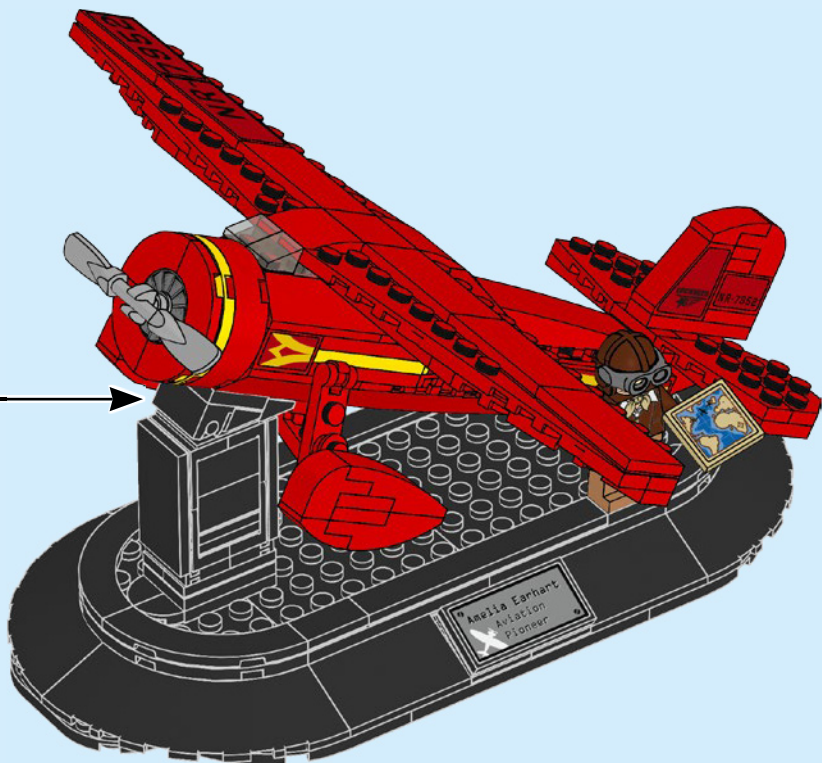



4x  
61224811



2x  
306901



1x  
4185177



2x  
6119197



3x  
302224



2x  
371024



1x  
4515349



1x  
6275404



1x  
4515371



4x  
6286215



3x  
6184782



1x  
6029946



2x  
6001806



2x  
6089698



2x  
4556153



1x  
306821



1x  
6105976



4x  
6310198



4x  
362321



1x  
6132210



1x  
4500462



3x  
371021



2x  
6057432



2x  
6045937



1x  
4610843



6x  
4560179



2x  
6275399



2x  
366621



2x  
4113858



4x  
379521

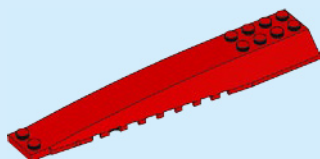

2x  
6287507

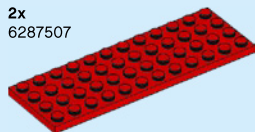

1x  
4514717

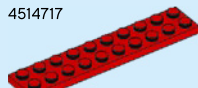

1x  
383221



1x  
447721



2x  
4161329



2x  
4160866



1x  
6170834



1x  
6170832



1x  
6054536



1x  
6054538



2x  
614121



2x  
6348058



2x  
302421



2x  
6335377



6x  
6173961



3x  
6092565



2x  
6186398



3x  
300421



9x  
302321



4x  
6172383



2x  
306826



4x  
6171264



2x  
6105963



2x  
4654580



4x  
4548180



3x  
4124096



2x  
416226

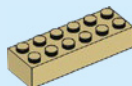

3x  
4181134



1x  
6093527



4x  
306926



2x  
300326



2x  
6133200



2x  
379523



2x  
6337380



3x  
393726



2x  
6199908

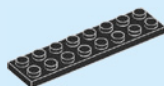

3x  
303426



2x  
302128



1x  
6123809



1x  
302326



2x  
302126



4x  
6337391



1x  
6262262



1x  
6278156



4x  
6000650



3x  
4560182

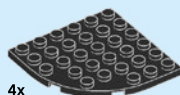

4x  
6137779



2x  
6245263



1x  
4211483



2x  
4107761



5x  
329726

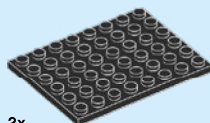

2x  
303626



1x  
6240219



1x  
4211394



1x  
302226



1x  
4527943



1x  
6117346



**Customer Service**

**Kundenservice**

**Service Consommateurs**

**Servicio Al Consumidor**

**LEGO.com/service or dial**



00800 5346 5555 :



1-800-422-5346 :



1x  
4507049



1x  
6170695



1x  
6338706



1x  
6338710