



# STAR WARS



75048



EN IMPORTANT: Never modify the elements or use other projectiles than provided with this toy.

DE WICHTIG: Die Elemente dürfen nicht verändert werden. Es dürfen ausschließlich die mit dem Spielzeug mitgelieferten Geschosse verwendet werden.

FR IMPORTANT : Ne jamais modifier les éléments ni utiliser d'autres projectiles que ceux fournis avec ce jouet.

IT IMPORTANTE: non modificare gli elementi o utilizzare proiettili non forniti con questo prodotto.

NL BELANGRIJK! Verander niets aan de elementen en gebruik geen andere projectielen dan de bij het speelgoed geleverde.

ES IMPORTANTE: No modifique los elementos ni utilice otros proyectiles diferentes a los suministrados junto con este juguete.

DA VIGTIGT: Elementerne må ikke ændres, og der må ikke bruges andre projektiler end dem, der følger med legetøjet.

FI TÄRKEÄÄ: Älä koskaan tee osiin muutoksia tai käytä lelussa muita kuin sen sisälttämiä ammuksia.

SV VIKTIGT: Modifiera aldrig delarna och använd aldrig andra projektiler än de som medföljer denna leksak.

PT IMPORTANTE: Nunca modifique os elementos nem utilize projecteis que não tenham sido fornecidos com este brinquedo.

EL ΣΗΜΑΝΤΙΚΟ: Ποτέ μην τροποποιείτε τα στοιχεία του παιχνιδιού και μην χρησιμοποιείτε άλλα βλήματα εκτός από αυτά που συνοδεύουν αυτό το παιχνίδι.

ZH 重要： 部品を改造したり、本製品に付属の発射体以外のものを使用しないでください。

JA 重要提示： 切勿更改组件或使用并非由本玩具附带的弹丸。

KO 중요함: 이들 부품을 수정하거나 이 완구와 함께 제공된 것이 아닌 발사체는 결코 사용하지 마십시오.

RU ВАЖНО: запрещается вносить изменения в элементы или использовать другие снаряды, отличные от тех, которые поставляются с данной игрушкой.

PL WAŻNE: Nigdy nie modyfikować elementów zabawki ani nie używać pocisków innych niż dostarczone z zabawką.

CZ UPOZORNĚNÍ: Nikdy neupravujte součástky a nepoužívejte jiné projektily než ty, které jsou dodávány s touto hračkou.

SK UPOZORNENIE: Nikdy neupravujte súčiastky a nepoužívajte iné projektily než tie, ktoré sú dodávané s touto hračkou.

HU FONTOS: Az elemeket nem szabad módosítani, és a játékhöz adott lövedékek helyett sem szabad mást használni.

UA ВАЖЛИВО: забороняється вносити зміни до елементів або використовувати інші снаряди на відміну від тих, що поставляються з цією іграшкою.

HR VAŽNO: Nemojte nikad mijenjati elemente ili koristiti druge projektile osim onih koji su bili priloženi uz ovu igračku prilikom kupnje.

SR Важно: Nemojte da modifikujete elemente i ne koristite druge projektile osim onih koji dolaze uz ovu igračku.

SL POMEMBNO: Nikoli ne spreminjajte elementov in uporabljajte le izstrelke, ki so bili priloženi tej igrači.

RO IMPORTANT: Nu modificați niciodată elementele și nu utilizați alte proiectile decât cele furnizate cu această jucărie.

BG ВАЖНО: Не видоизменяйте елементите и не използвайте други снаряди освен приложените към тази играчка.

LV SVARĪGĪ! Nekad nepārveidojiet rotālietas elementus, vienmēr izmantojiet tikai tās komplektā iekļautās lodītes.

ET OLULINE: Mänguasja osi ei tohi teistega asendada, kasutada võib ainult kaasasolevat heitkeha.

LT DĖMESIO! Niekuomet nekeiskite elementų ir naudokite tik tuos šovinius, kurie yra pridėti prie šio žaislo.

TR ÖNEMLİ: Hiçbir zaman parçalarda değişiklik yapmayın veya bu oyuncakla sağlananlar dışında mermiler kullanmayın.



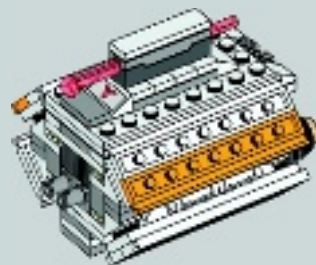
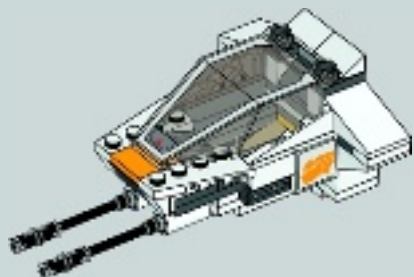

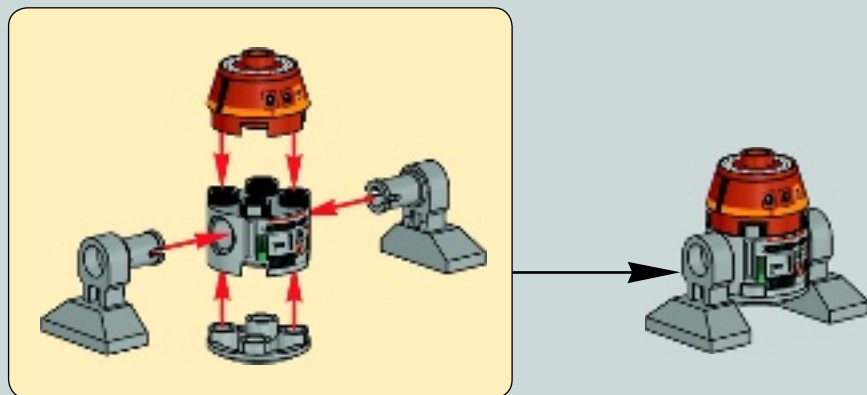
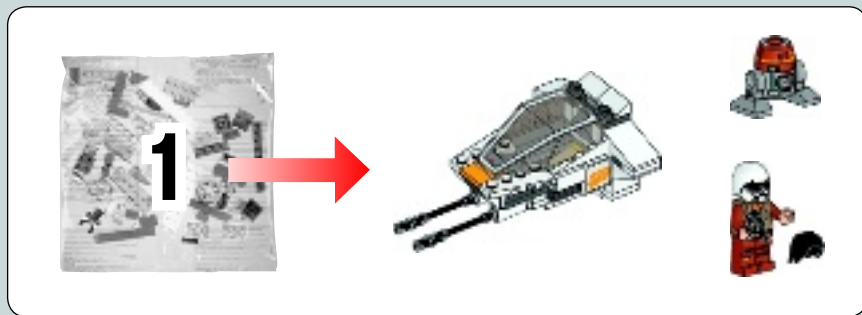

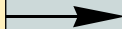
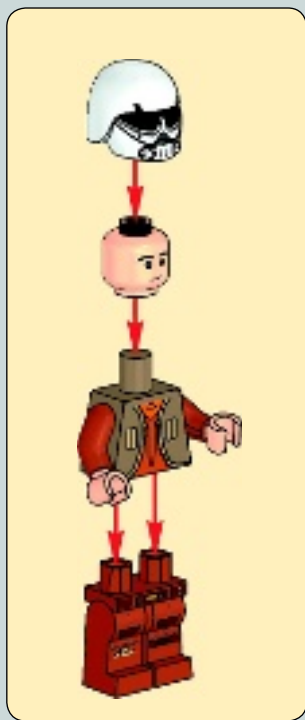



1

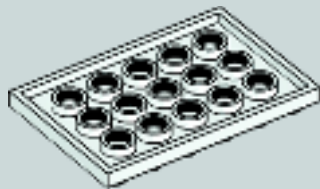

2

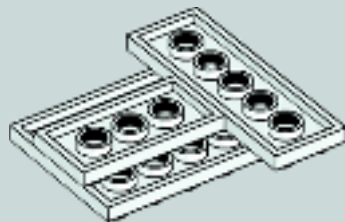



1x



1x

# 3

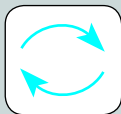

2x



1x

# 4

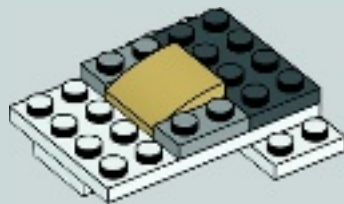





1x



2x

# 5



2x



1x

# 6

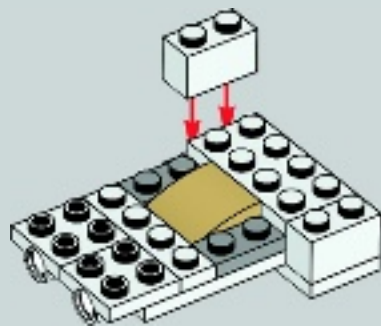



7

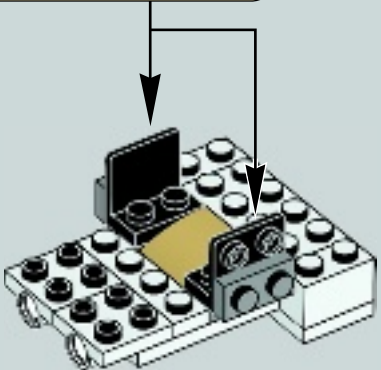
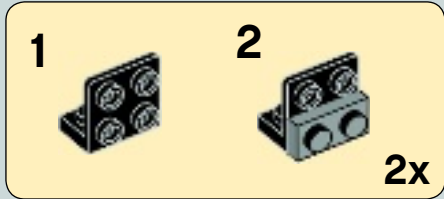



2x



2x

# 8

1



2



2x





1x



2x

9



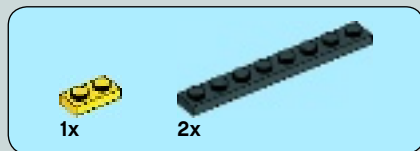

10

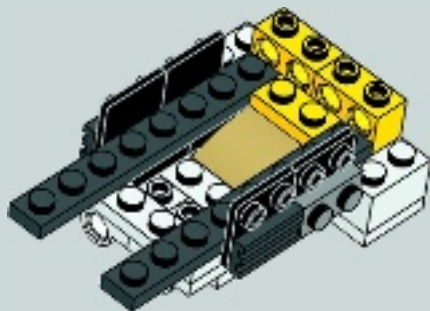

11

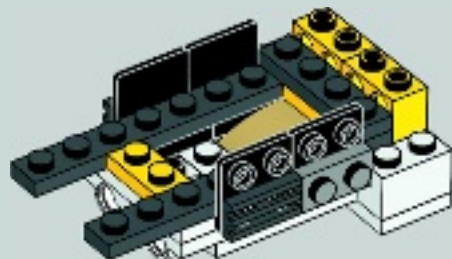



1x



2x

# 12

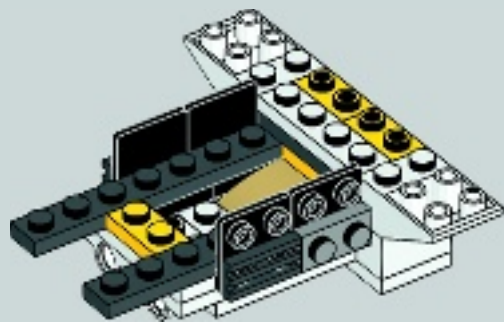



2x

# 13

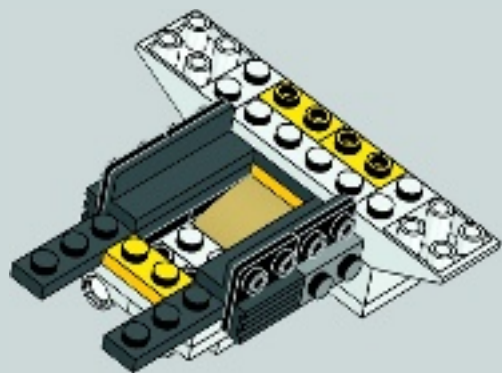

1x



1x

# 14

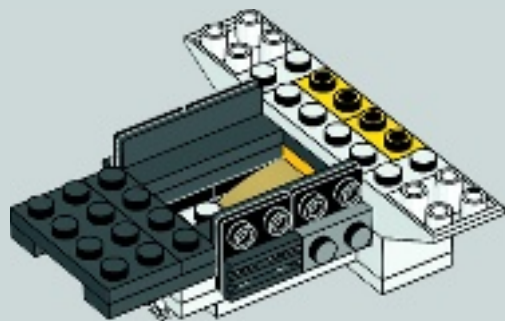



2x



1x

# 15

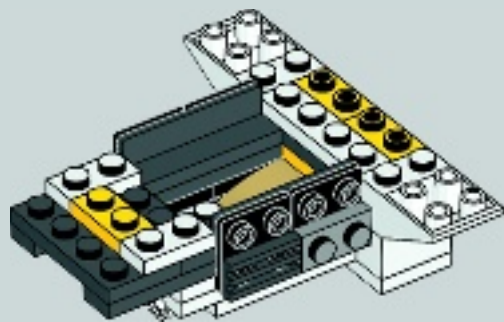





2x

# 16

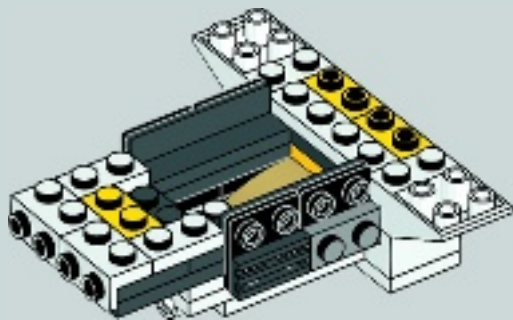

2x



1x

# 17

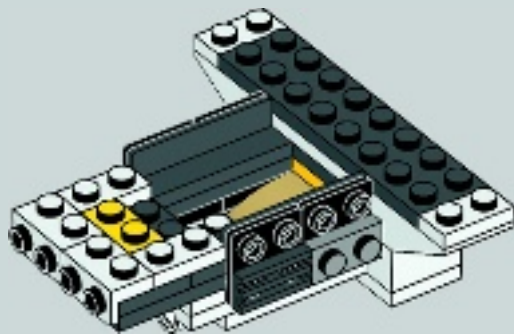



2x



1x

# 18

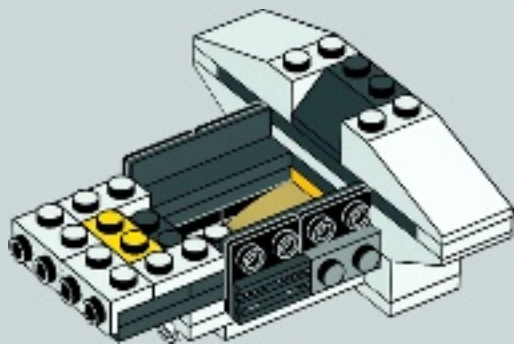

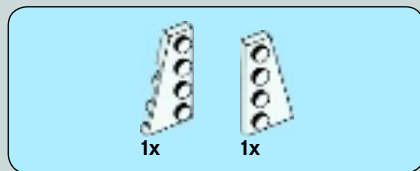

19

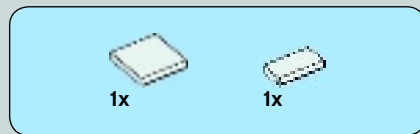
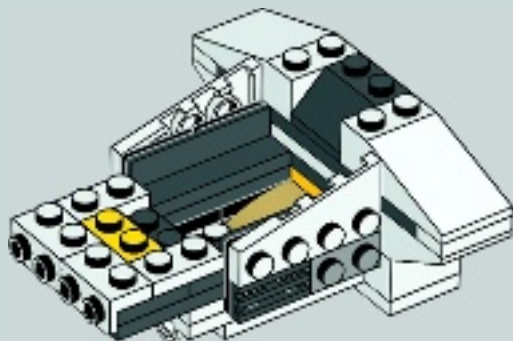

20

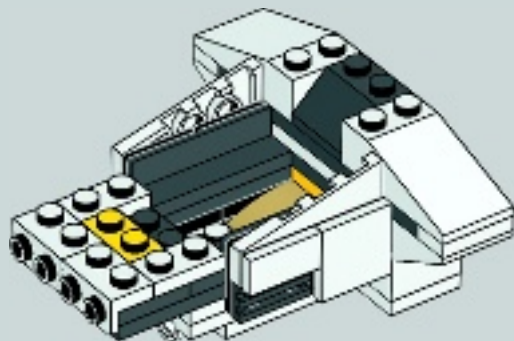



1x



1x

# 21

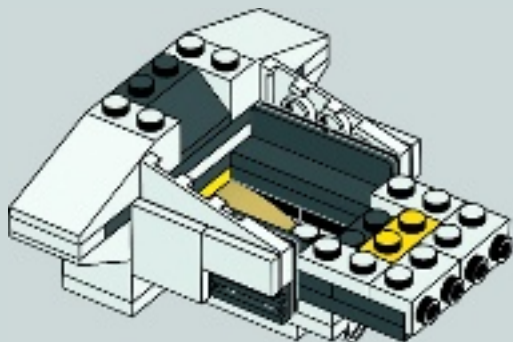
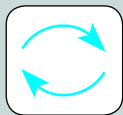



2x



1x

# 22

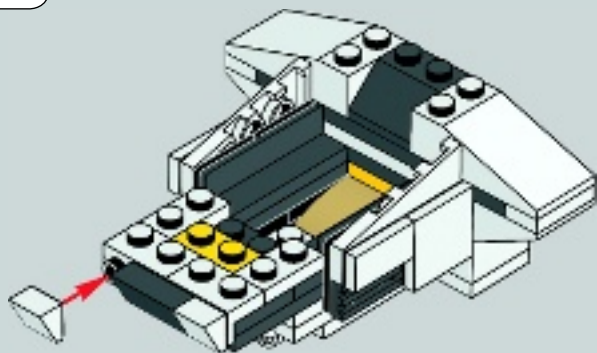
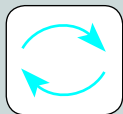

1x



1x

# 23

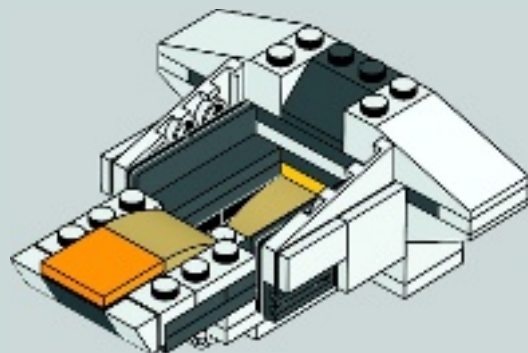

24

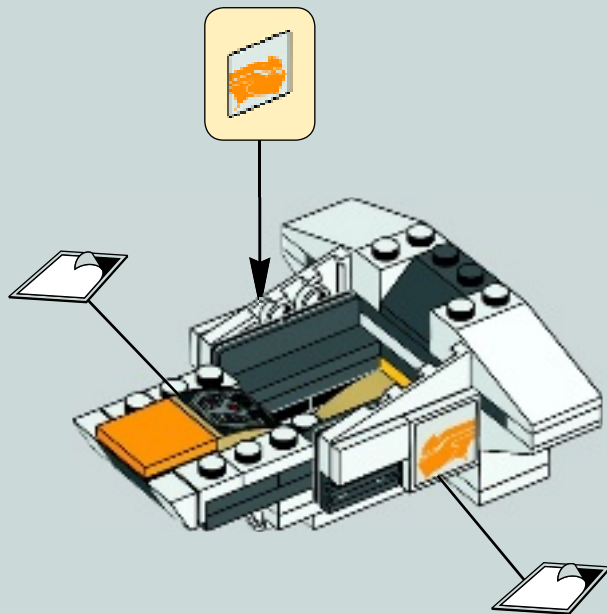

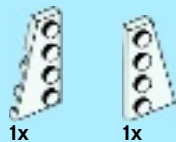

1x

1x

# 25

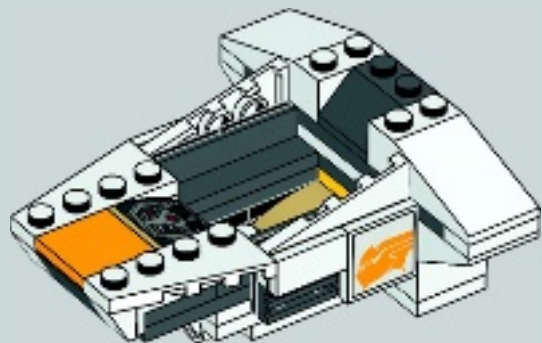

2x



1x

# 26

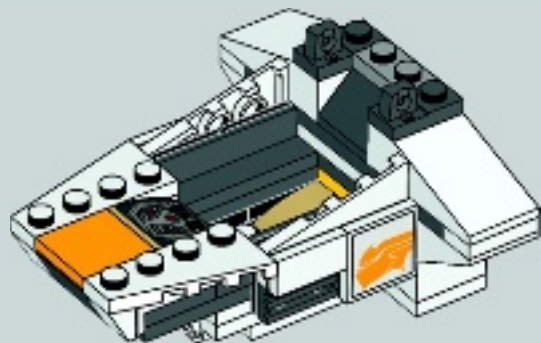



2x

27

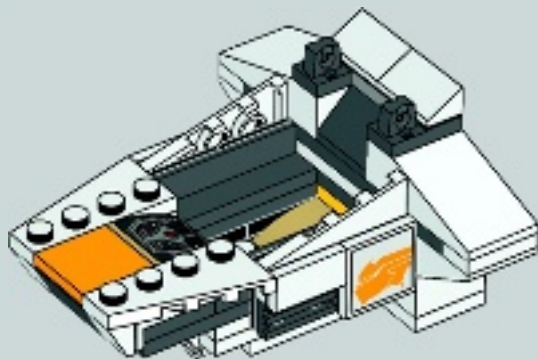



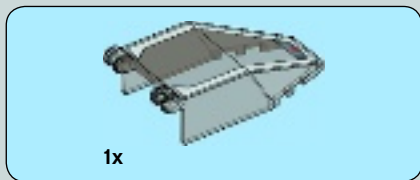

28

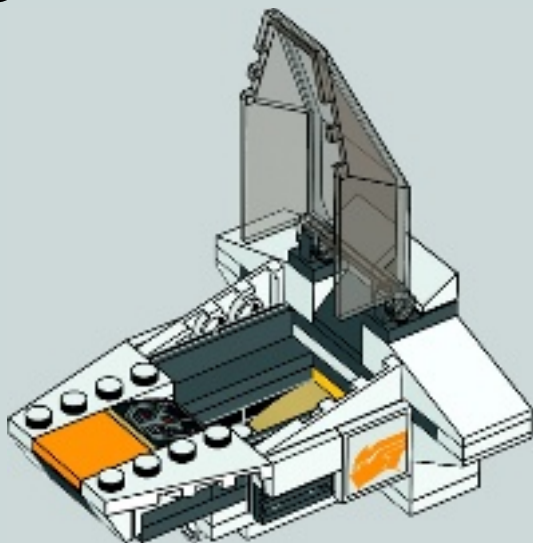

29

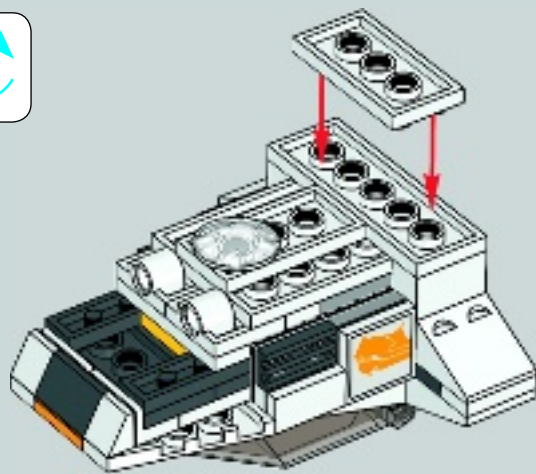
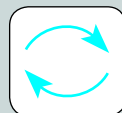

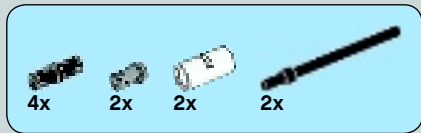

30

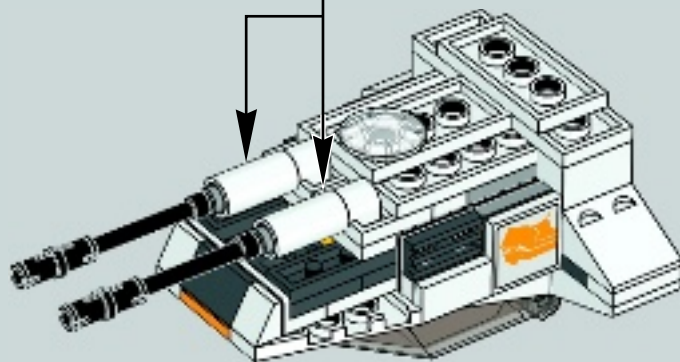
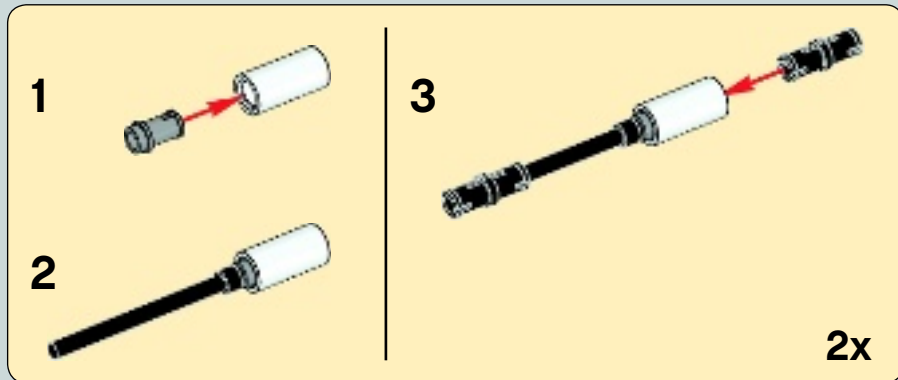

# 31

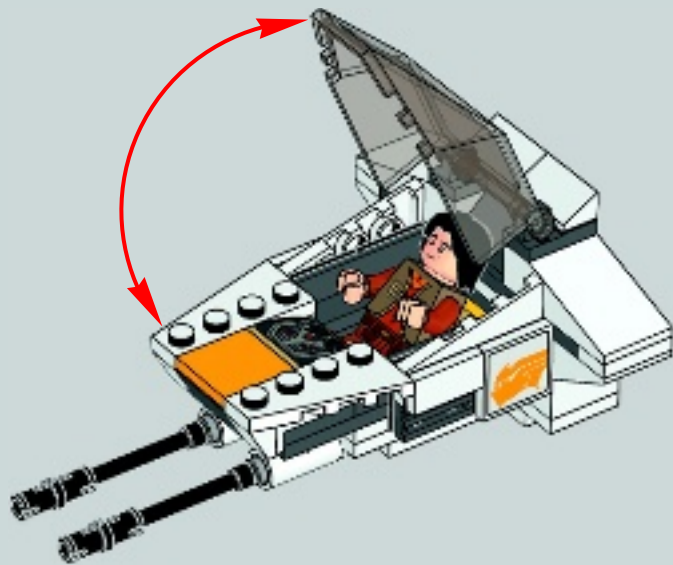
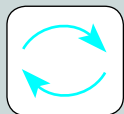

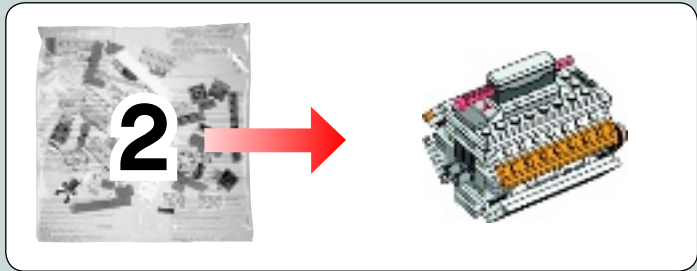

**2**

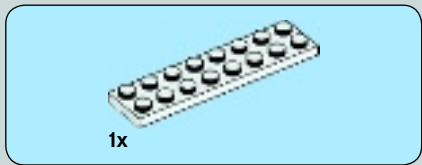

**1**

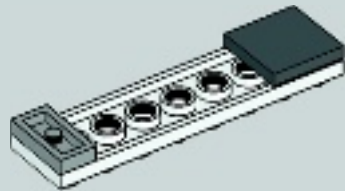
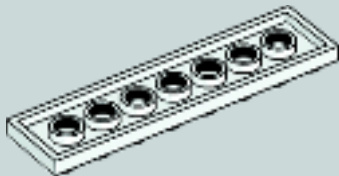



2x

3

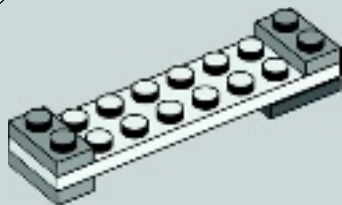
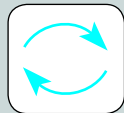

6x

4

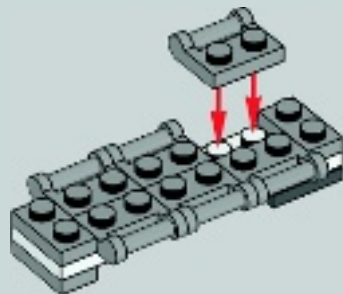



2x

5

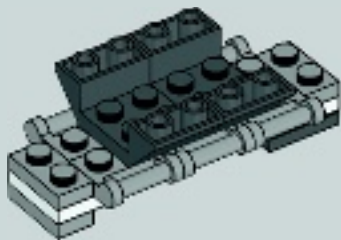



4x

# 6

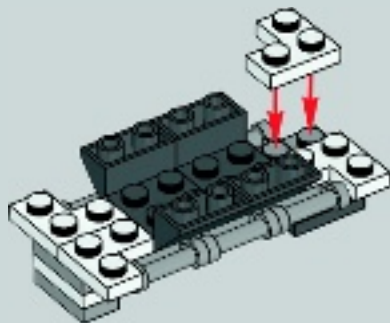

3x



1x



1x

# 7

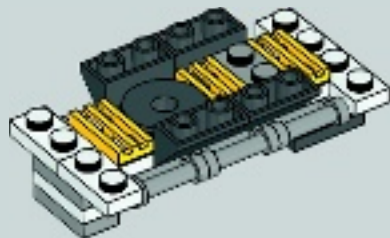



1x

1

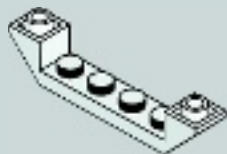

1x

2

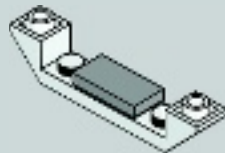

2x



2x

3

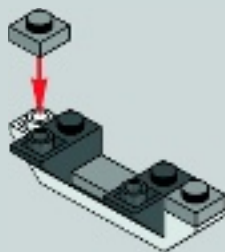





2x

4

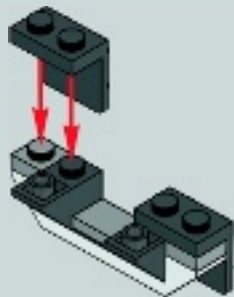

2x



2x

5

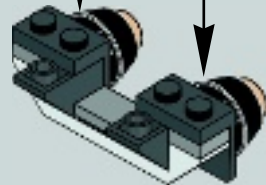



2x

6

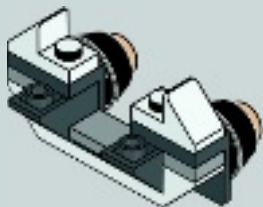

2x



2x

7



2x

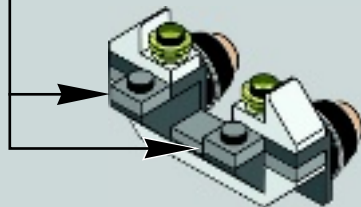



1x



2x

8



9

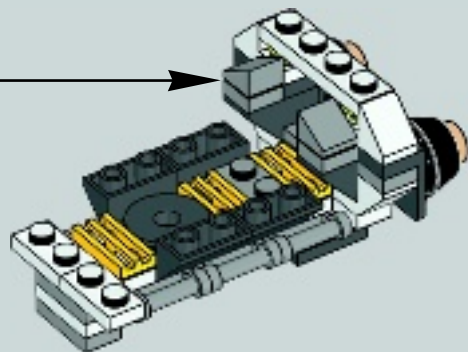



2x



4x



1x



1x

# 10

## 1

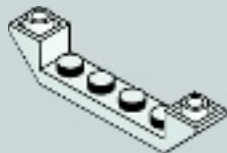

## 2

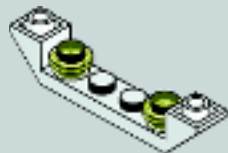

## 3

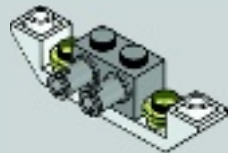

4

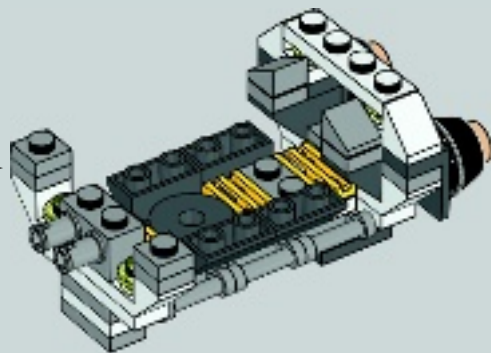
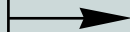
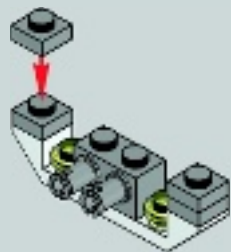



2x

# 11

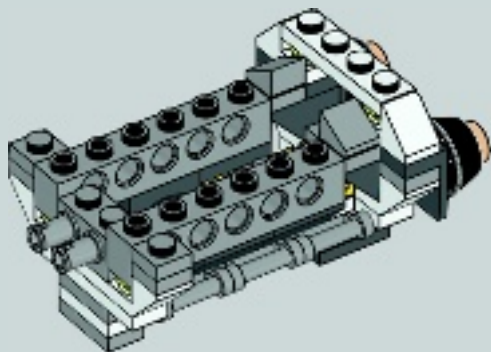

4x

# 12

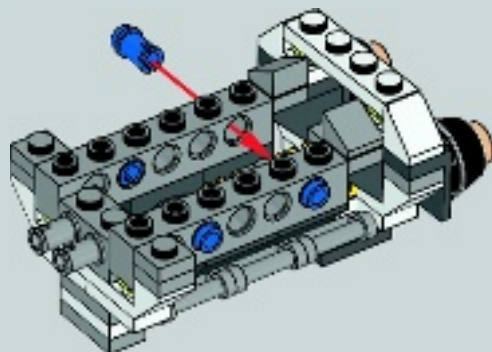

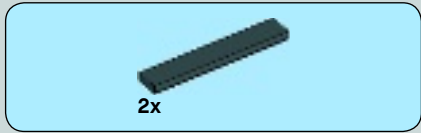

# 13

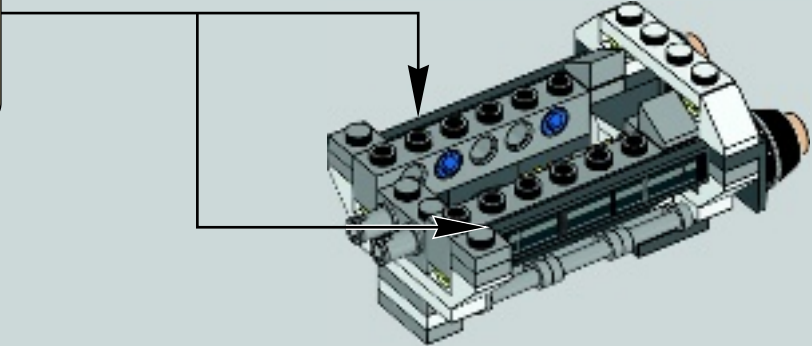
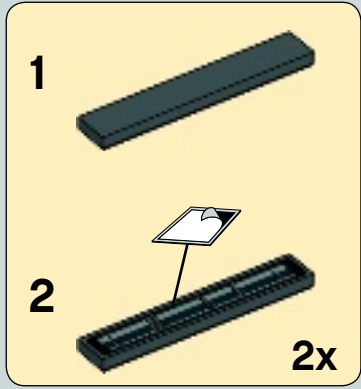



14

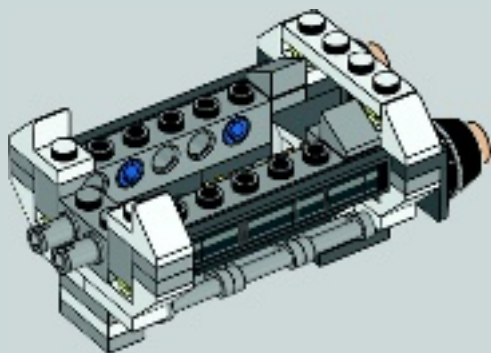

15

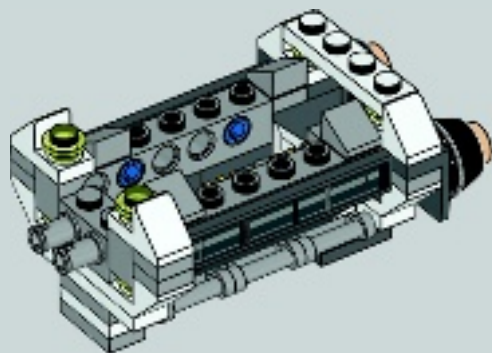





16

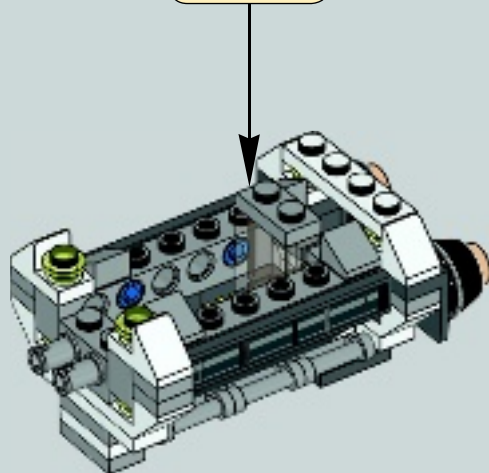
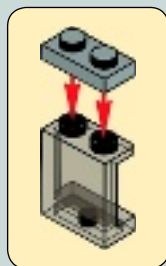



5x

17

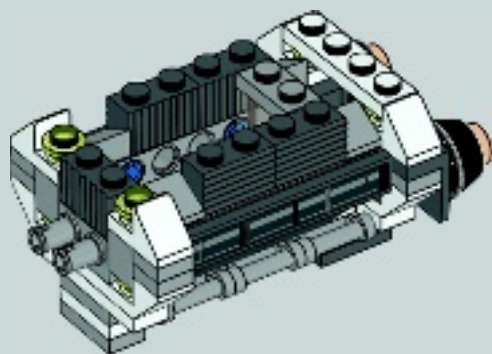



1x

# 18

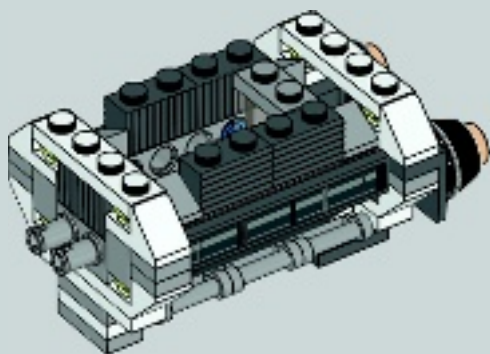



2x



1x

# 19

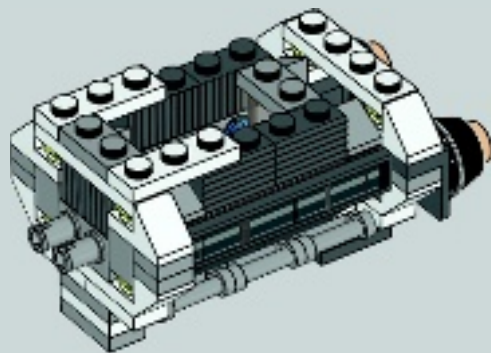



20

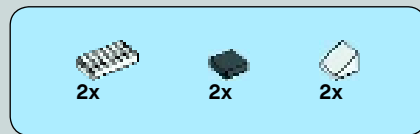
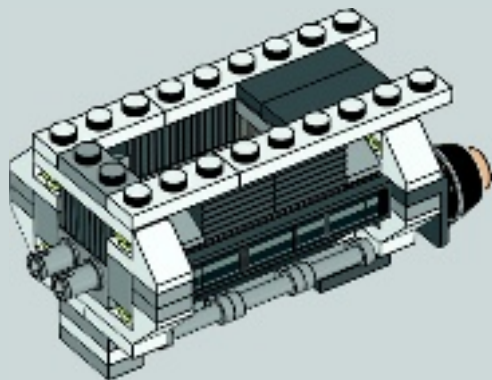

21

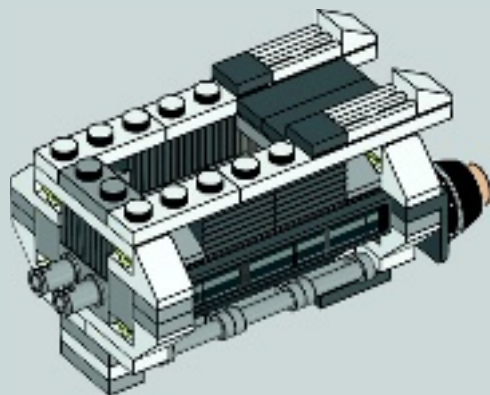



1x



2x

# 22

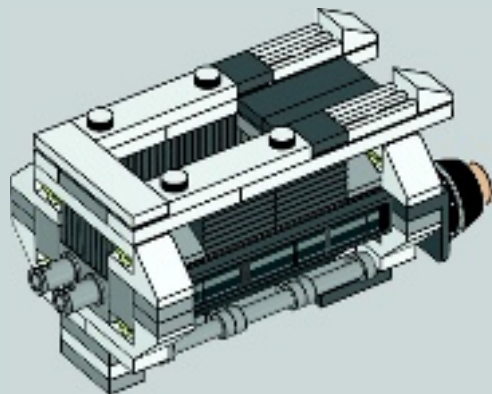

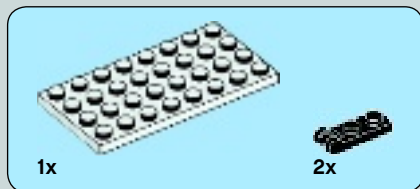

# 23

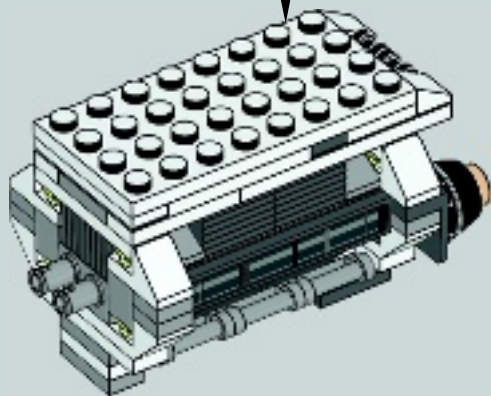
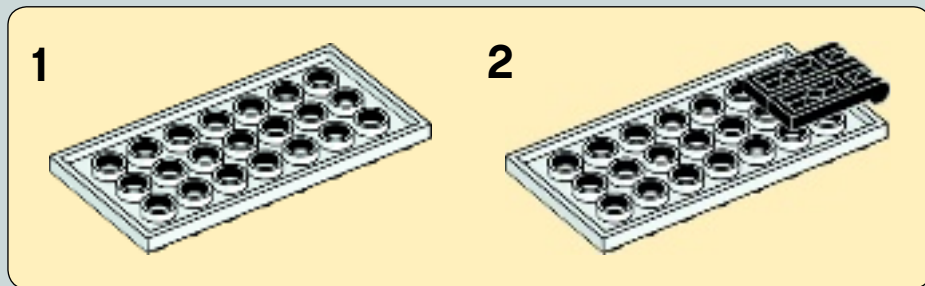



1x

# 24

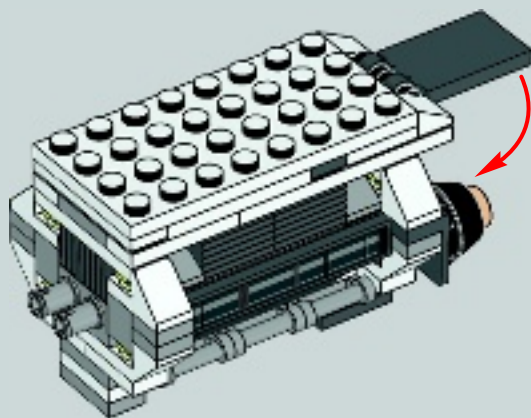





2x



2x



2x



2x

4x



8x



4x

# 25

## 1

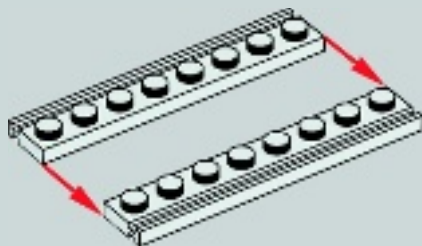

## 2

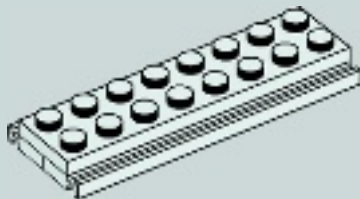

**3**

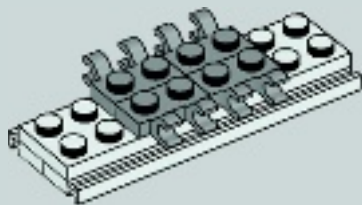

**4**

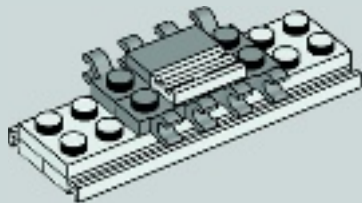

**5**

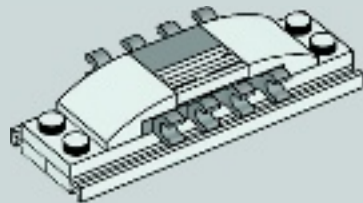

**2x**

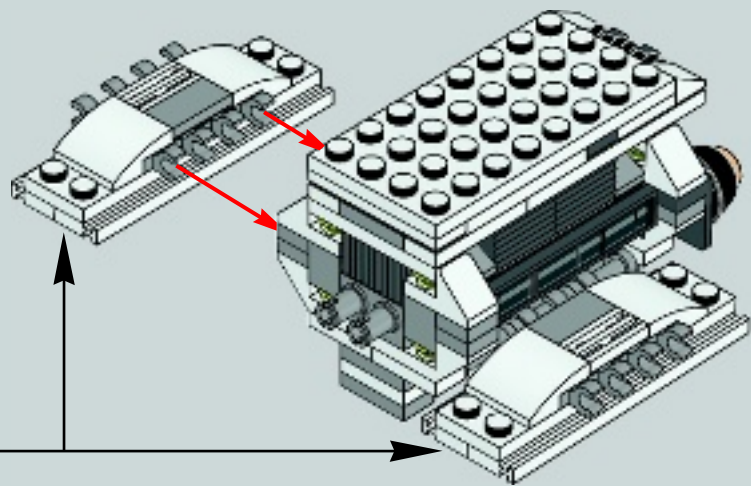



2x



4x



4x



2x

2x



2x



2x

26

1

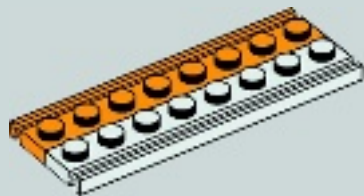

2

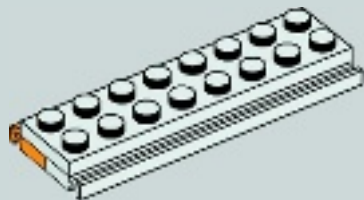

3

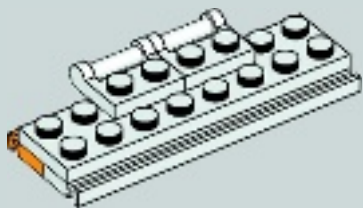

4

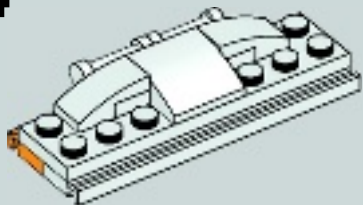

2x

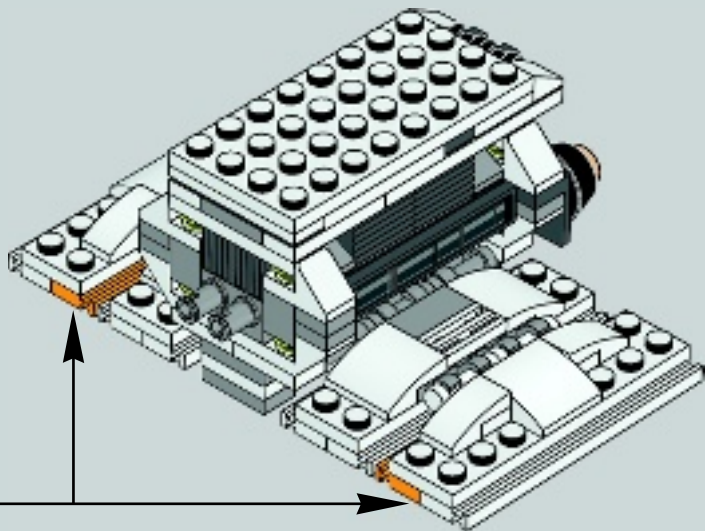

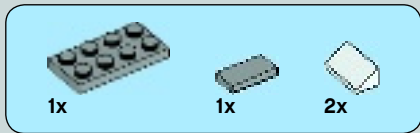

27

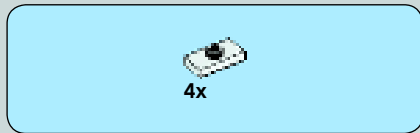
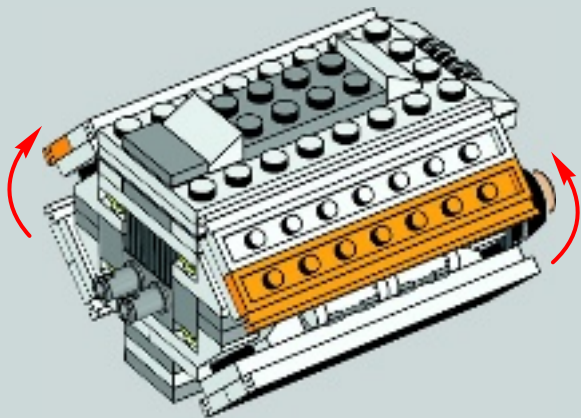

28

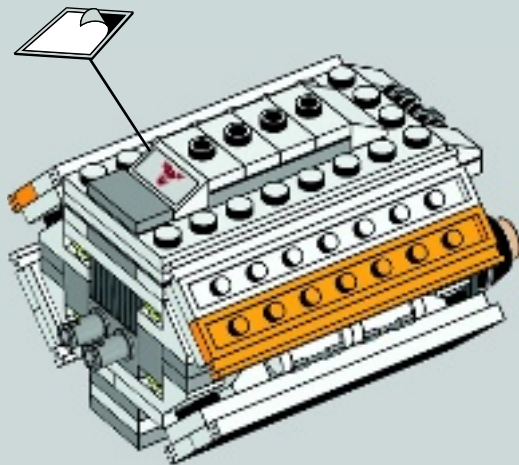

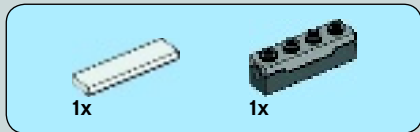

29

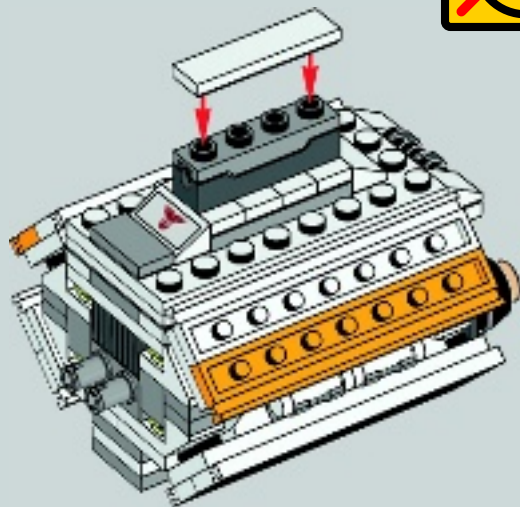

# 30

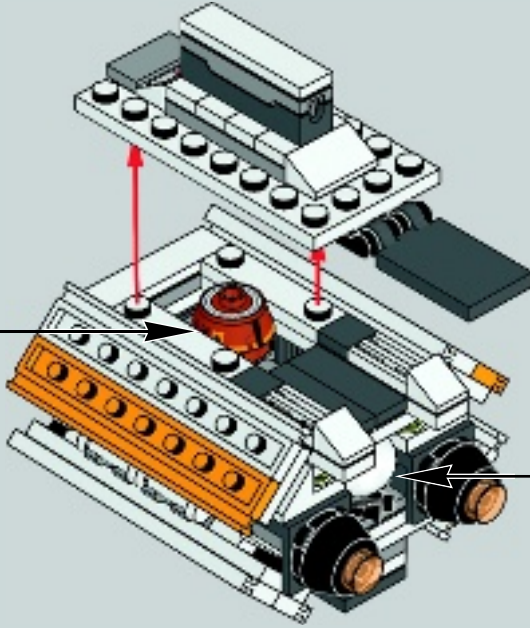



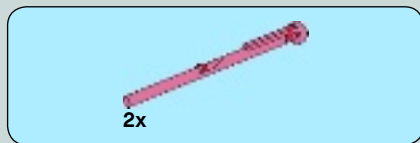

31

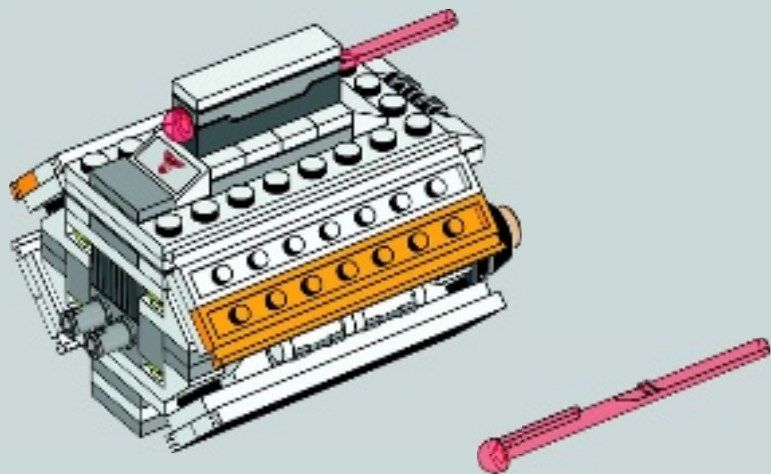



32

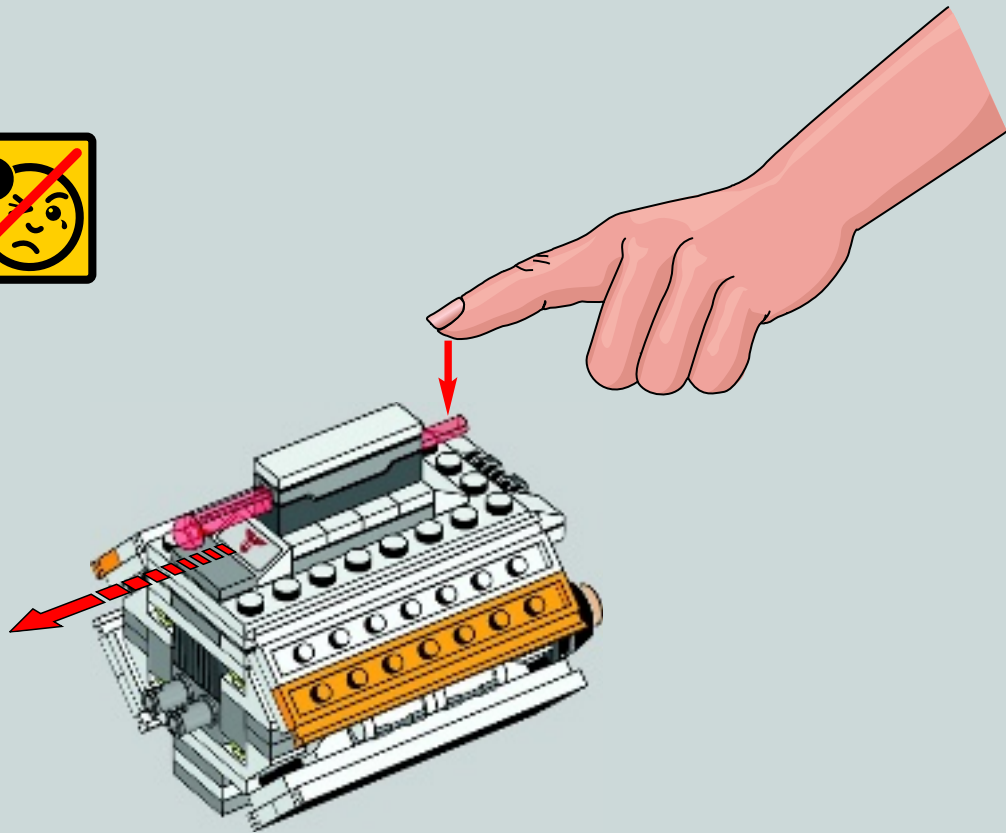

33

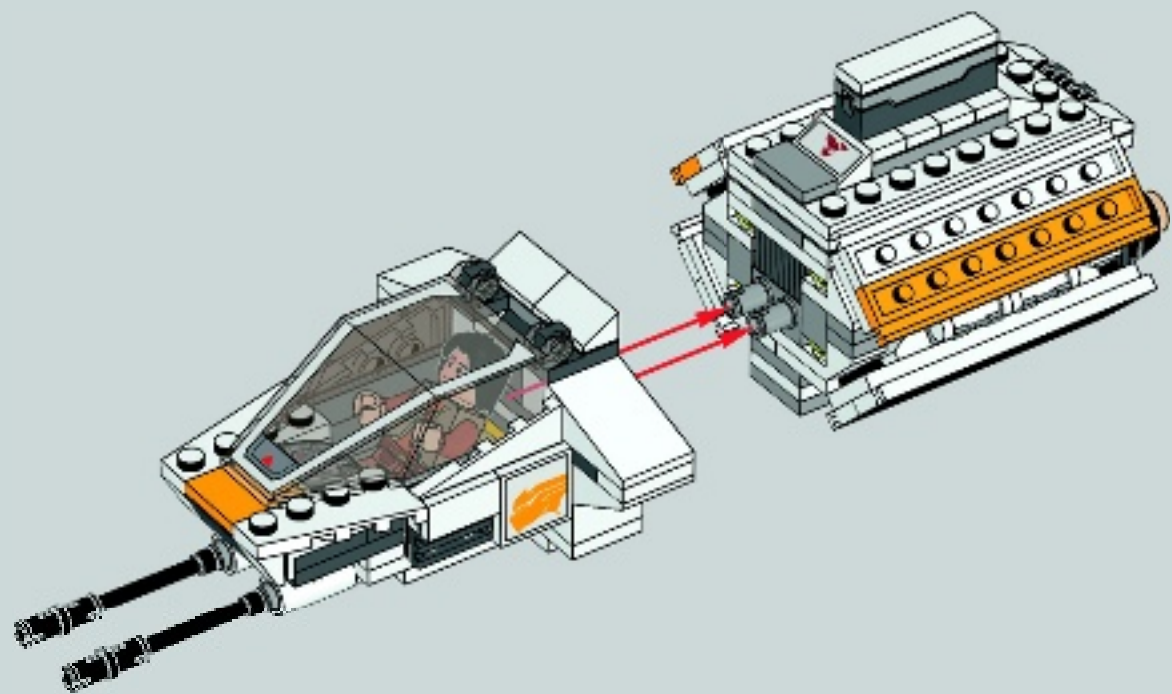

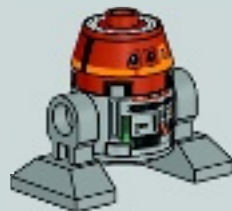
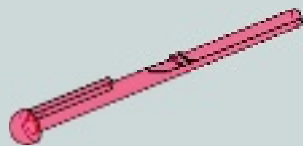
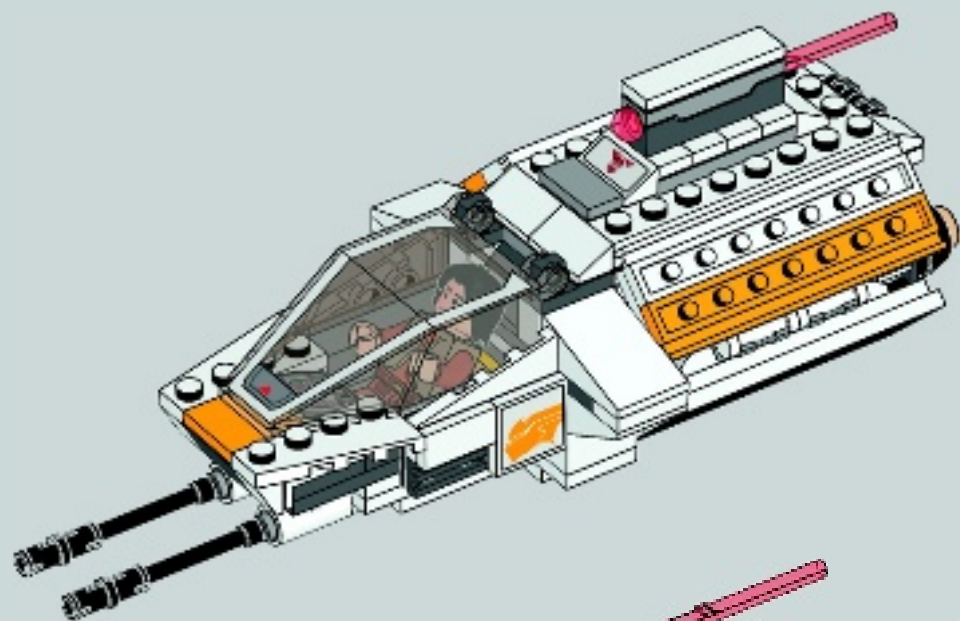



**Customer Service**

**Kundenservice**

**Service Consommateurs**

**Servicio Al Consumidor**

**LEGO.com/service or dial**



**: 00800 5346 5555**

**: 1-800-422-5346**



[LEGO.com/starwars](http://LEGO.com/starwars)



75048



75049



75050



75051



75052



75053



75054



 [LEGO.com/starwars](http://LEGO.com/starwars)

75055





# LEGO.com/productfeedback

## GEWINNE



Erzähle uns auf  
[www.LEGO.com/productfeedback](http://www.LEGO.com/productfeedback)

etwas über die Erfahrungen, die du mit  
diesem LEGO® Set gemacht hast, und  
sichere dir die Chance auf einen coolen  
LEGO Preis!

## GAGNE



Rends-toi sur  
[www.LEGO.com/productfeedback](http://www.LEGO.com/productfeedback)

et donne-nous quelques commentaires  
sur ce produit LEGO® pour avoir une  
chance de gagner un prix LEGO !

## GANAN



Visita  
[www.LEGO.com/productfeedback](http://www.LEGO.com/productfeedback)

y envíanos tu opinión acerca de este set  
LEGO®. ¡Participarás en el sorteo de un  
premio LEGO!

## 获取奖品



登录  
[www.LEGO.com/productfeedback](http://www.LEGO.com/productfeedback)

给出关于此乐高®套装的简短反馈，  
就有机会获得炫酷乐高奖品

LEGO and the LEGO logo are trademarks of the LEGO Group. ©2014 The LEGO Group. © & TM Lucasfilm Ltd.

6106876