

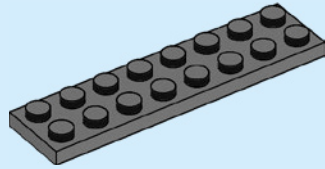

1

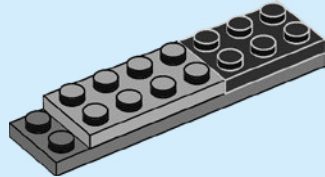

2



3

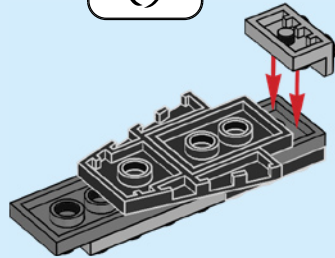

4

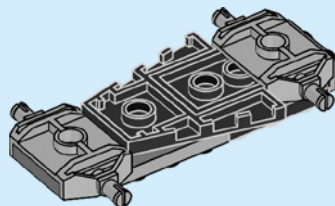

5

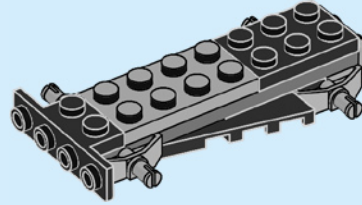

6

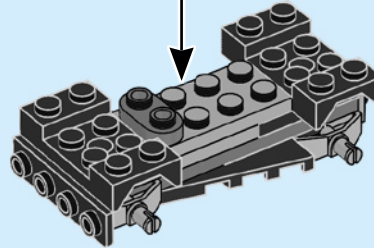
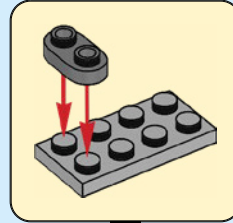

7

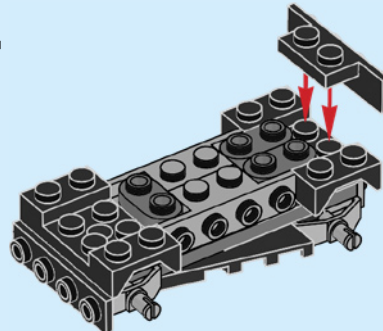

8

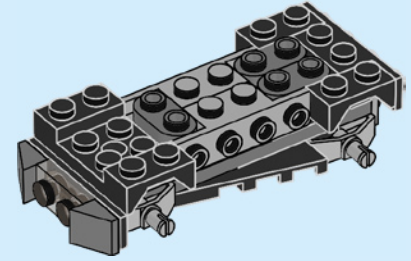

9

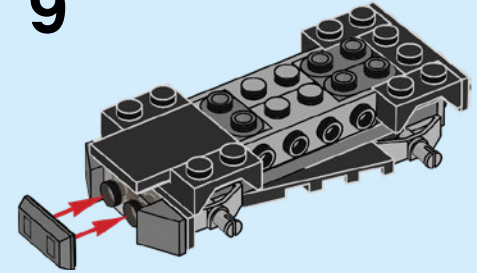

10

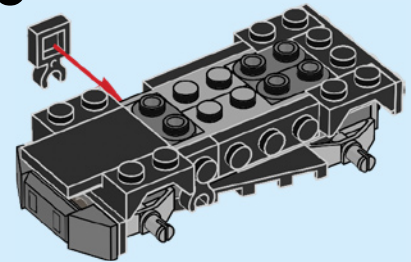

11

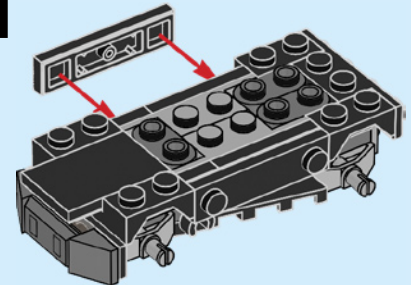

12

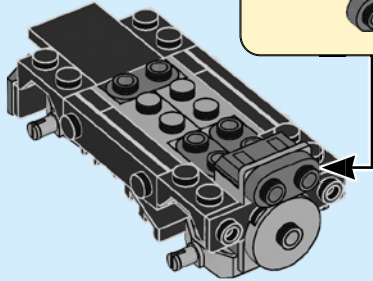
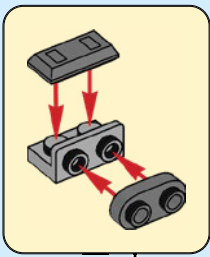

15

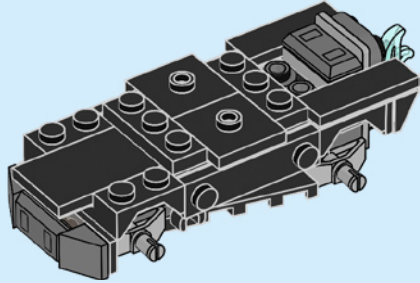

17

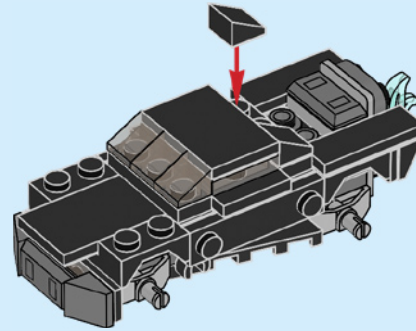

20

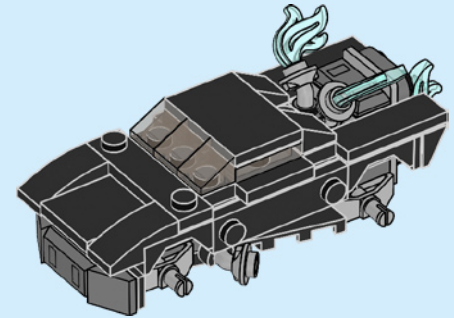

13

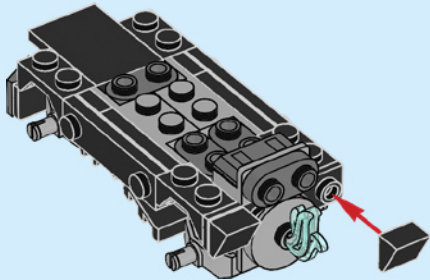

18

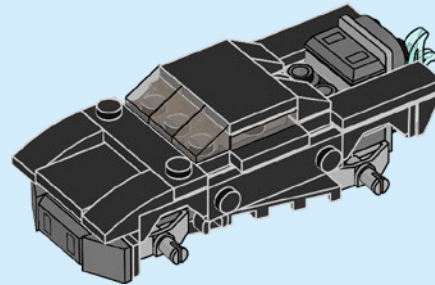

LEGO.com/DCSUPERHEROES

LEGO.com/service

LEGO and the LEGO logo are trademarks of the LEGO Group.
©2022 The LEGO Group. 6380101



THE BATMAN and all related characters and elements © & ™ DC Comics and Warner Bros. Entertainment Inc. WB SHIELD: © & ™ WBEI. (s22)

14

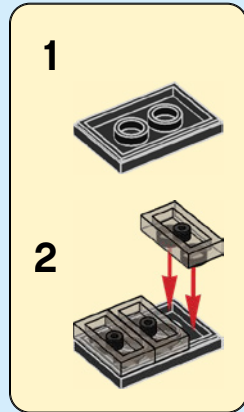
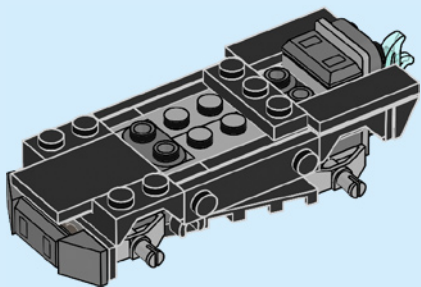

16

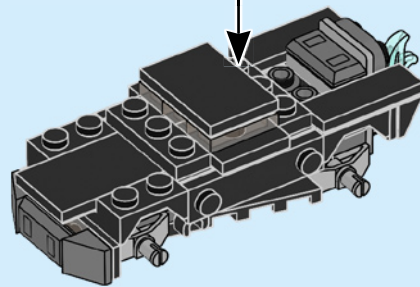

19

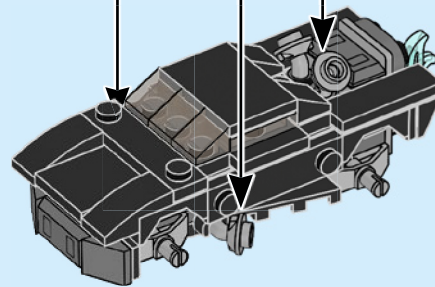
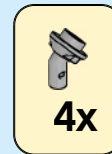

21

