

The LEGO logo is displayed in its characteristic white, bold, sans-serif font with a black outline, set against a solid red square background.

ages/edades

4+

3600

idea book

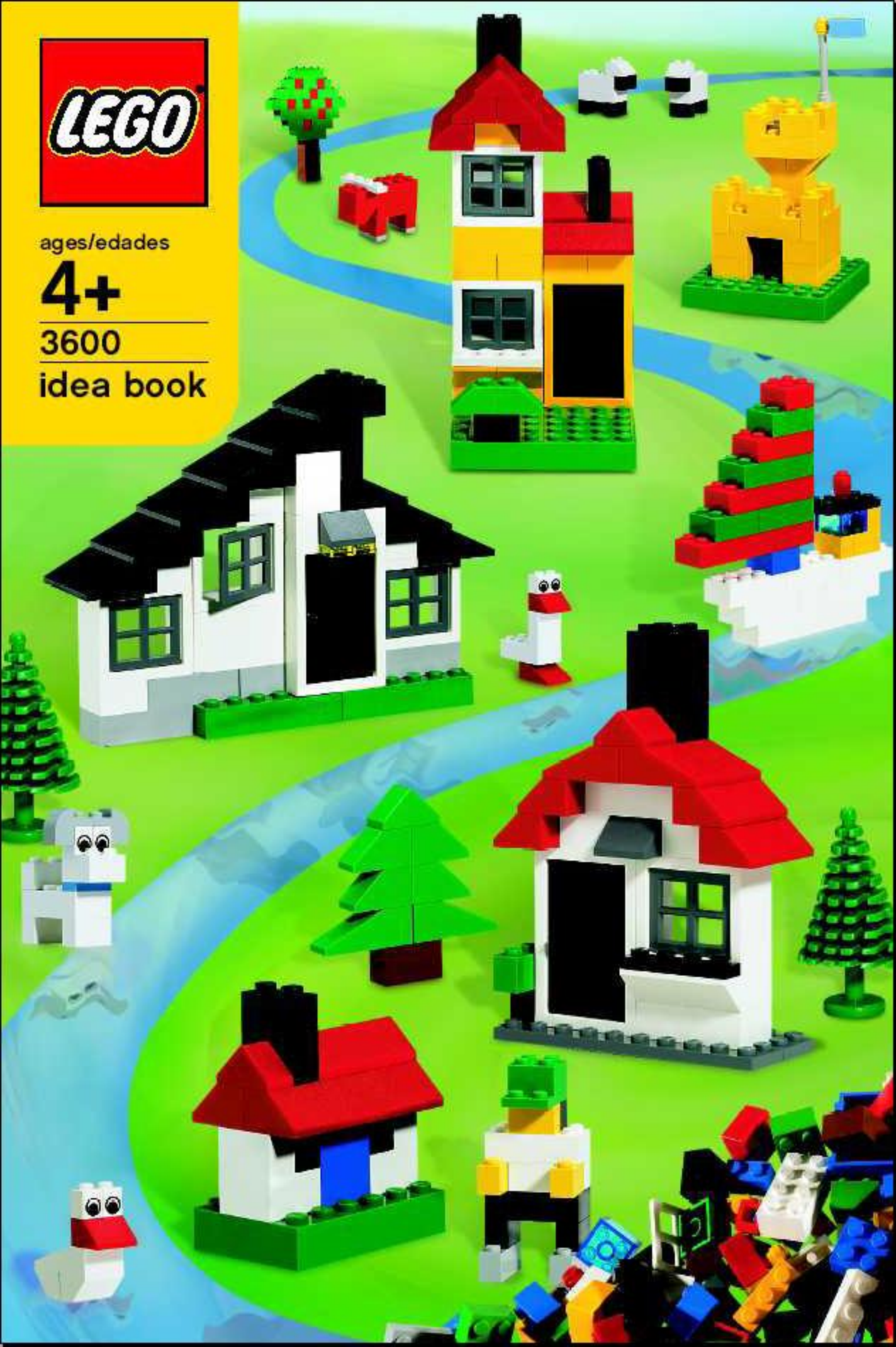

Contents

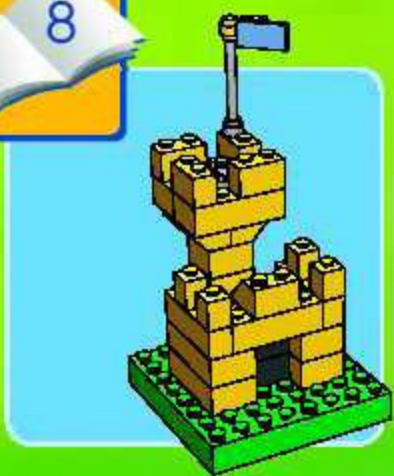
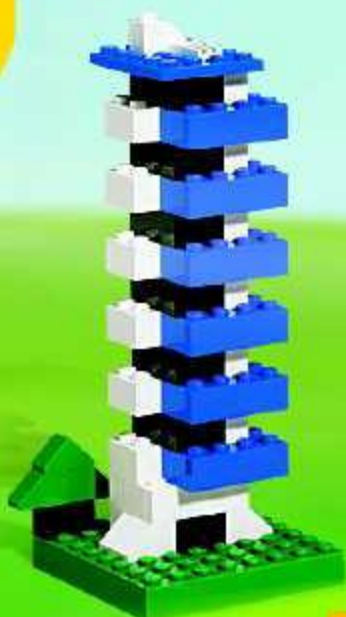

Pictured models cannot be built simultaneously
Die abgebildeten Modelle lassen sich nicht gleichzeitig bauen
Les modèles présentés ne peuvent pas être construits simultanément
I modelli illustrati non possono essere costruiti simultaneamente
De afgebeelde modellen zijn niet tegelijkertijd te bouwen
Los modelos ilustrados no pueden construirse simultáneamente
De viste modeller kan kun bygges én ad gangen
Kuvissa näkyvät mallit voidaan rakentaa yksi kerrallaan
Modellema som visas kan inte bygges samtidigt
Os modelos nas imagens não podem ser construídos em simultâneo
Τα μοντέλα που απεικονίζονται δεν μπορούν να κατασκευαστούν ταυτόχρονα
A képen látható modelleket nem építheted meg egyszerre







1

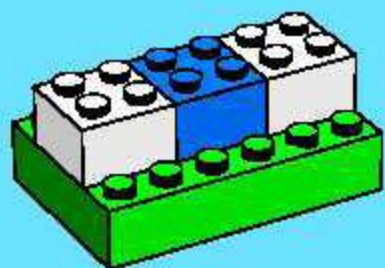

2

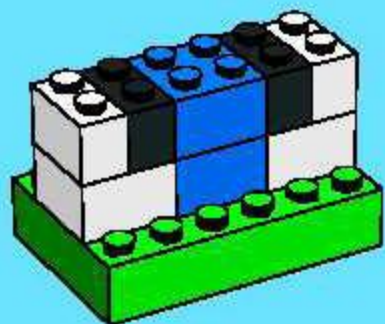

3



4









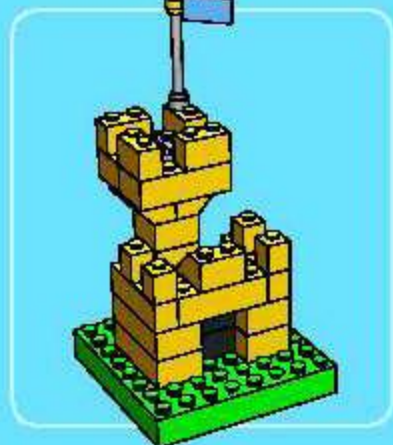

1

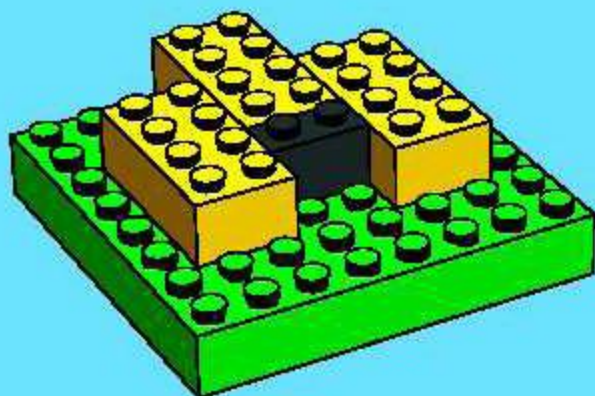

2

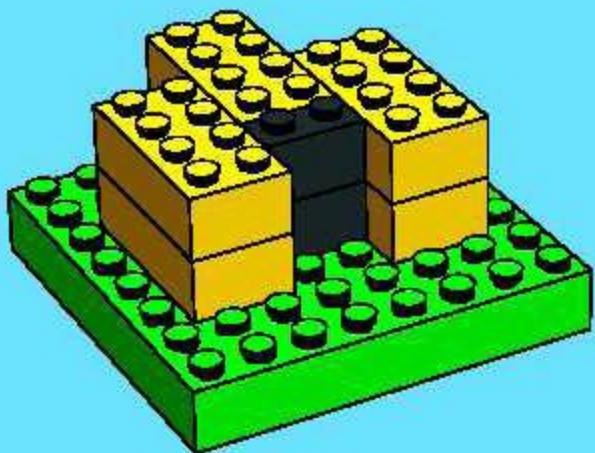

3

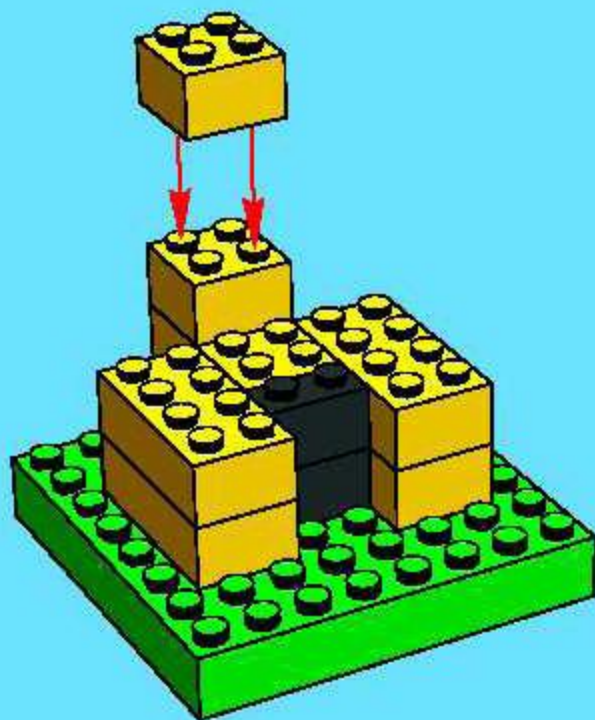

4

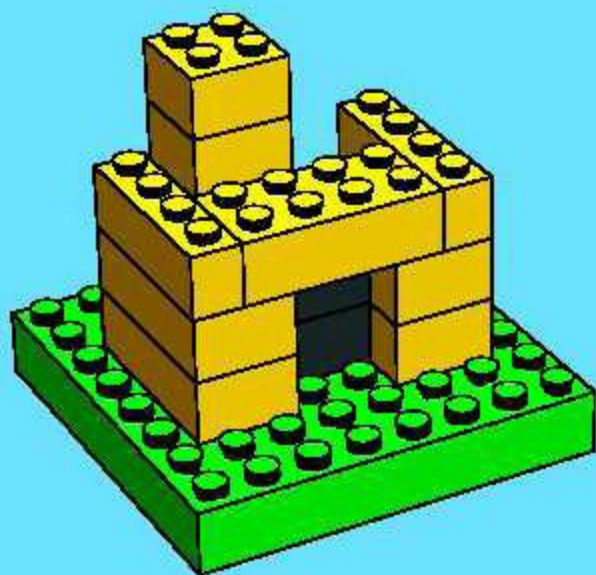

5

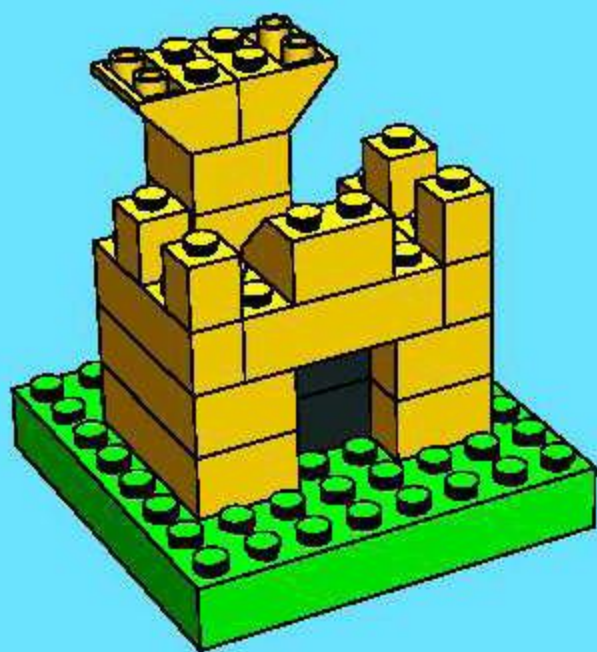

6

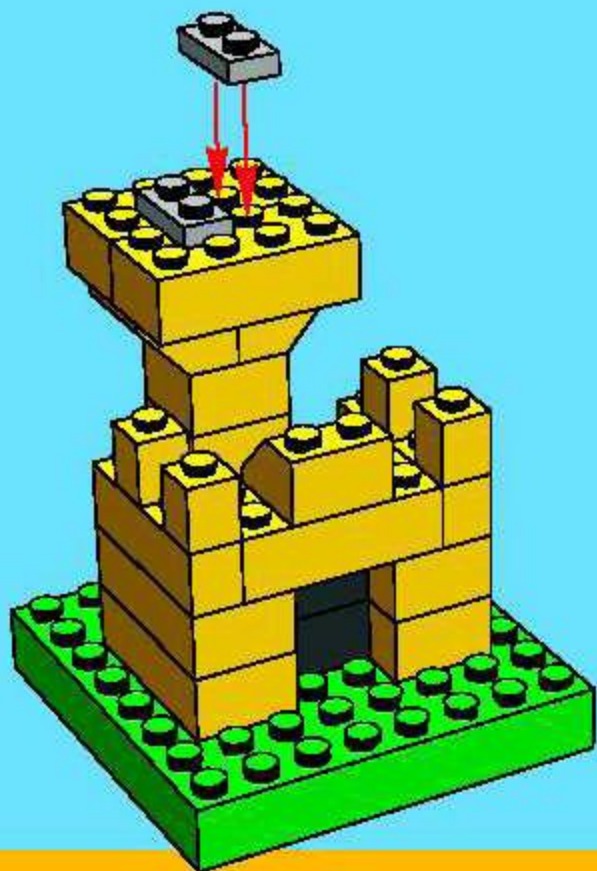

7

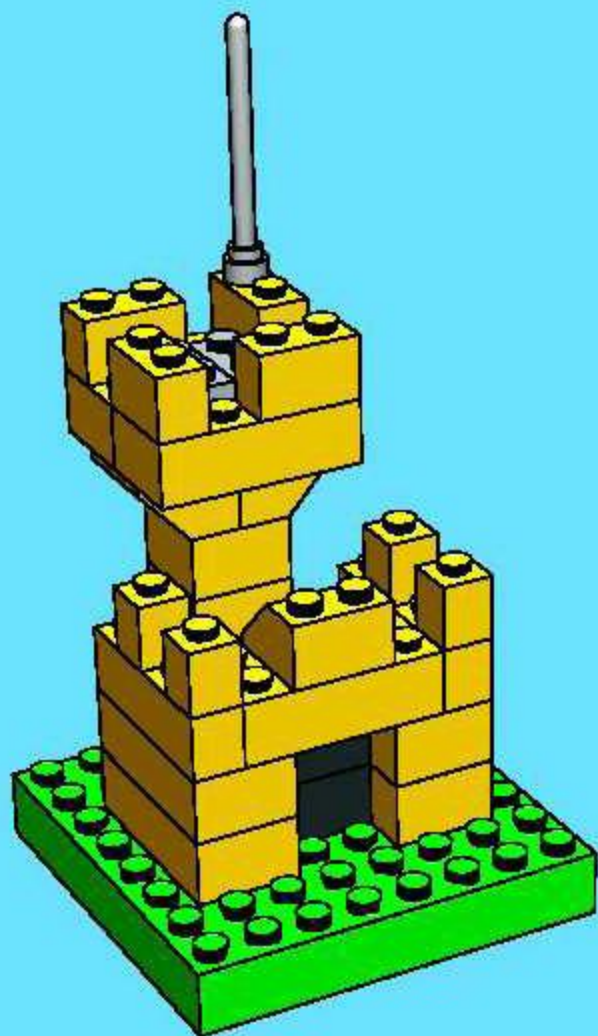

8

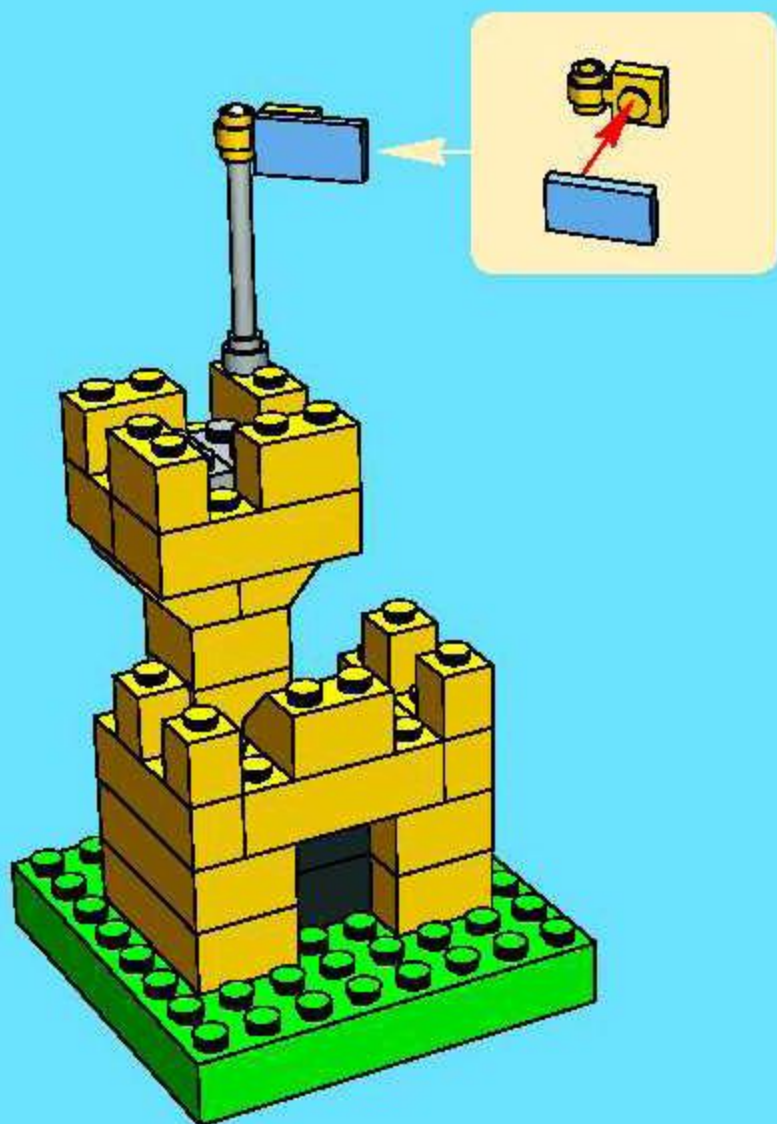





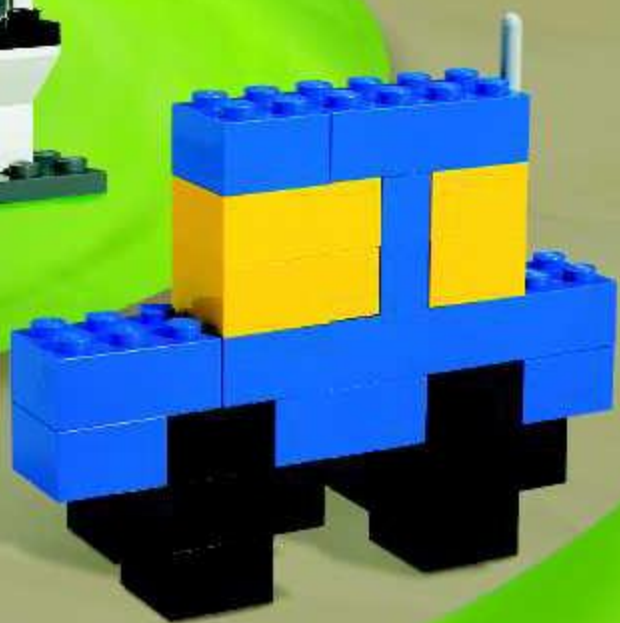



1

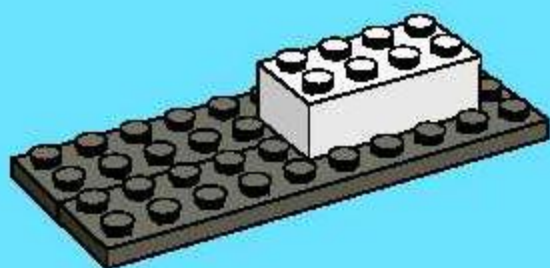

2



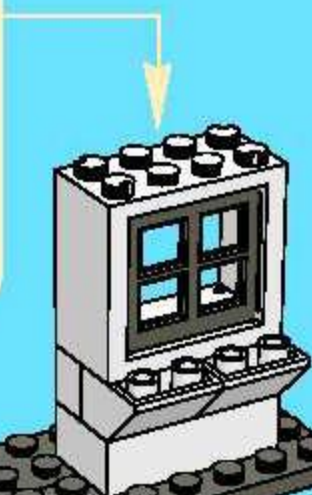
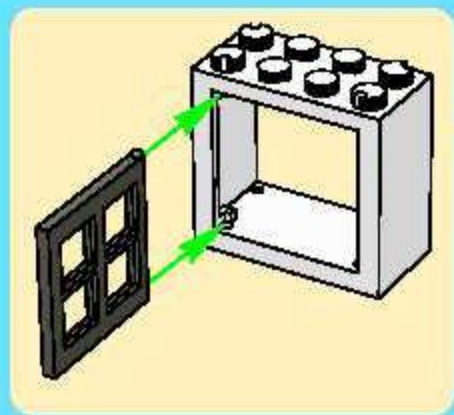

3

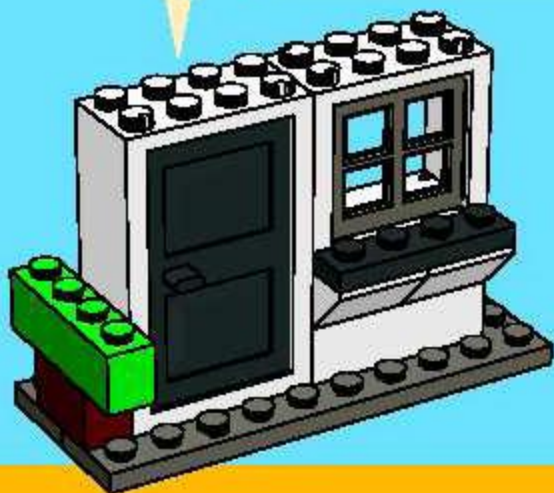
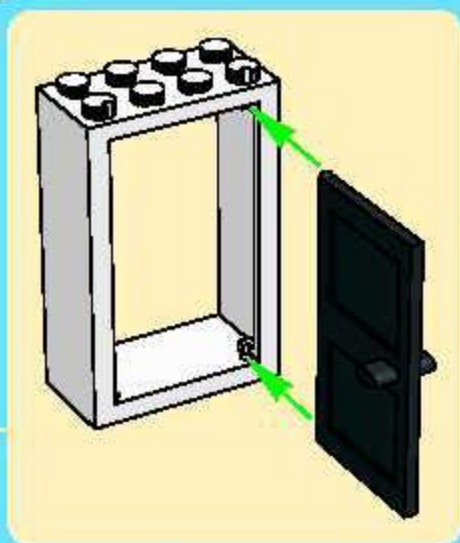

4

5

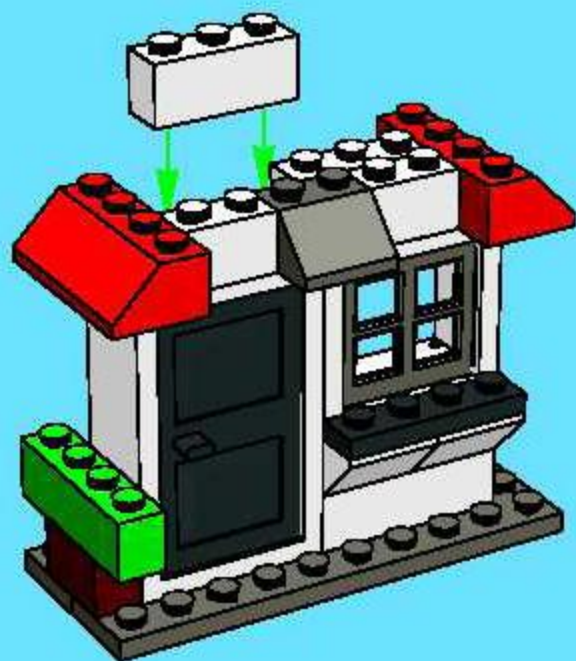

6

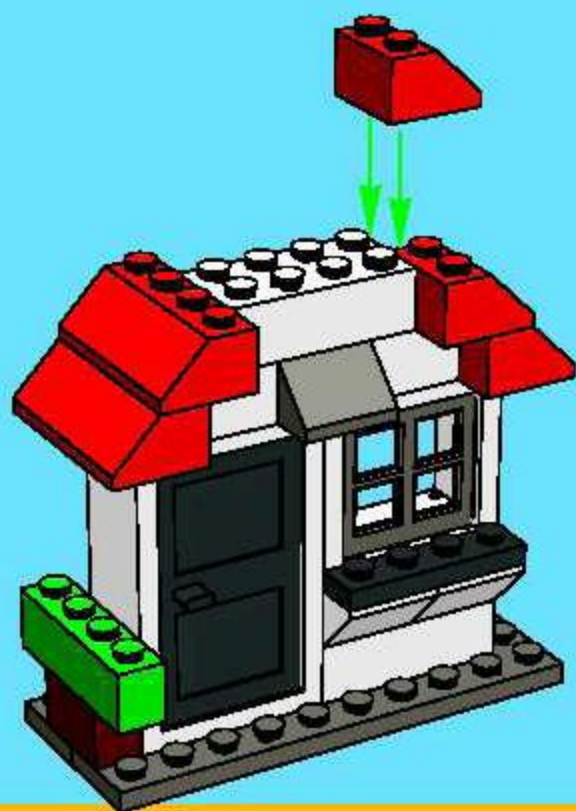

7



8



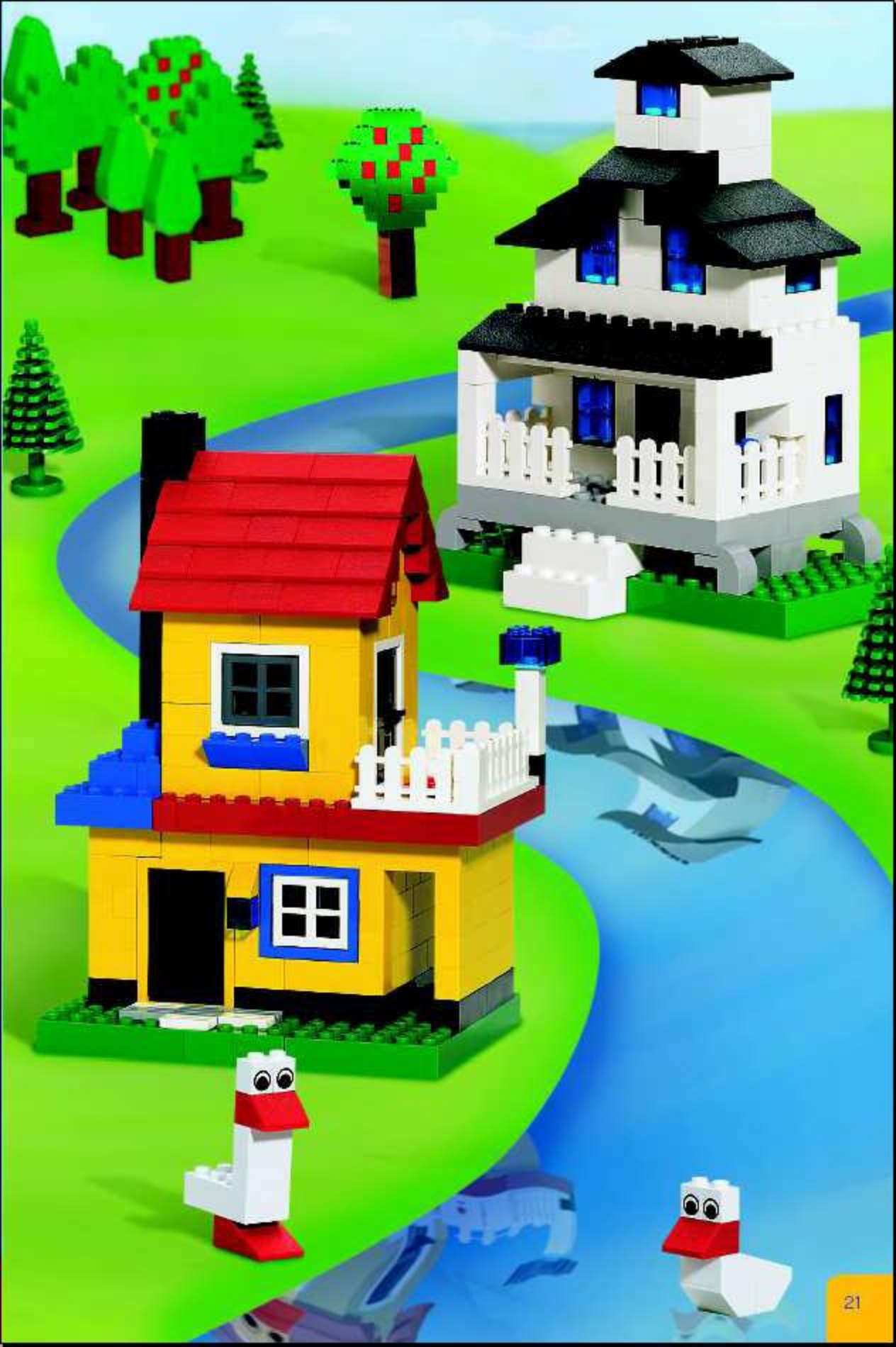

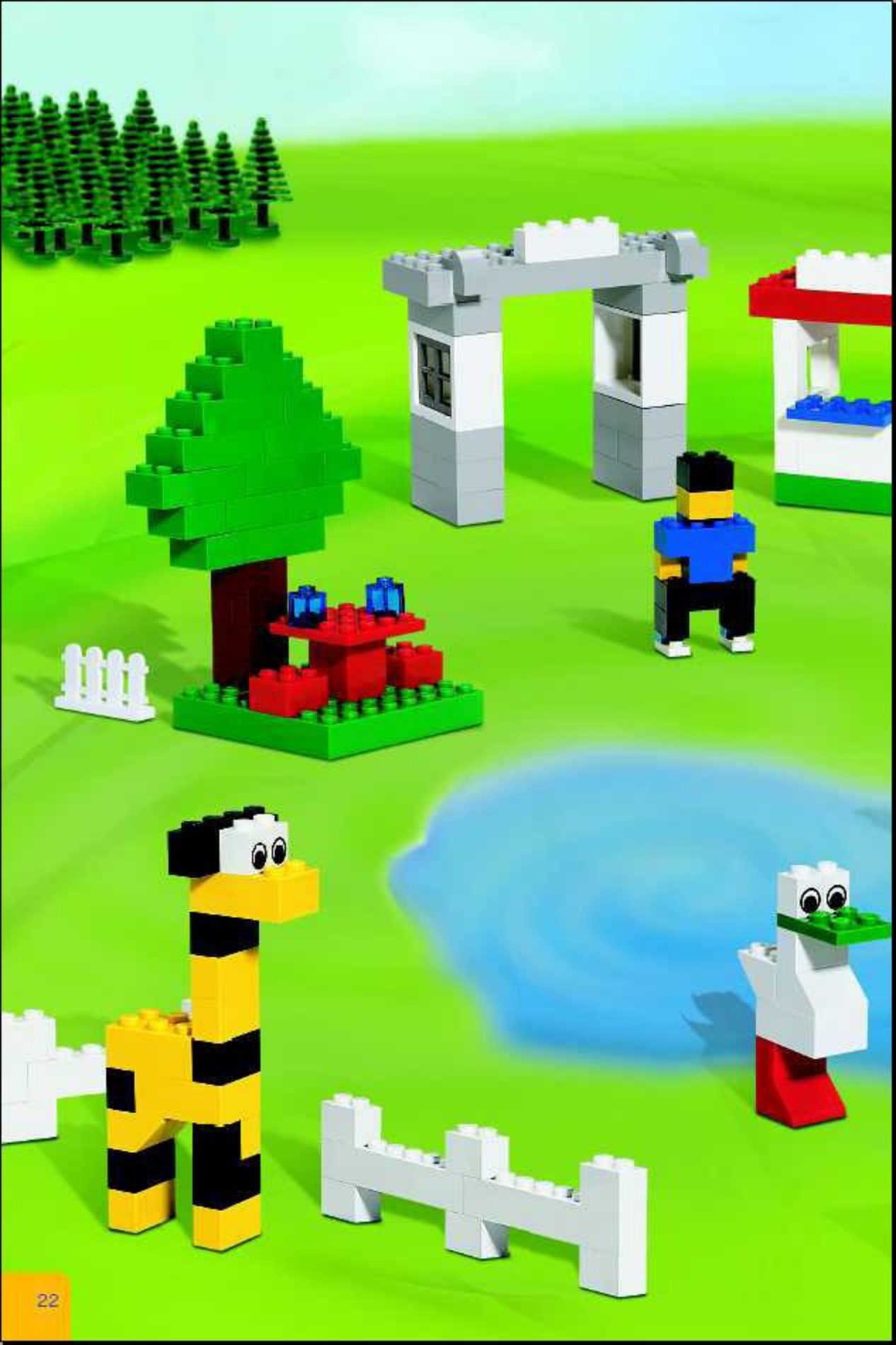





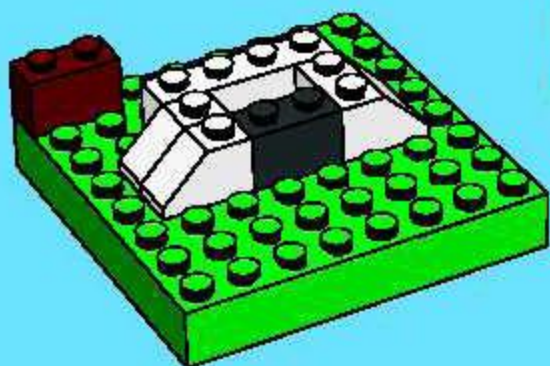

1

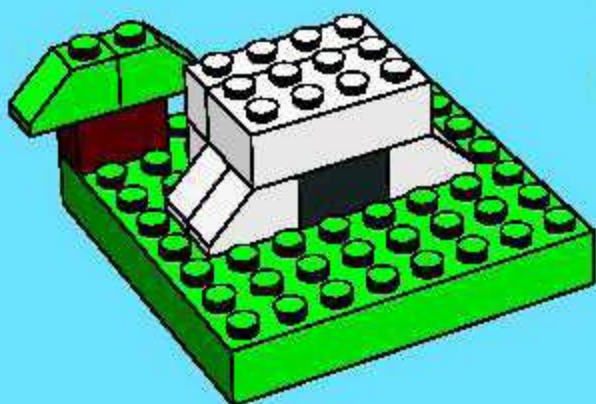

2

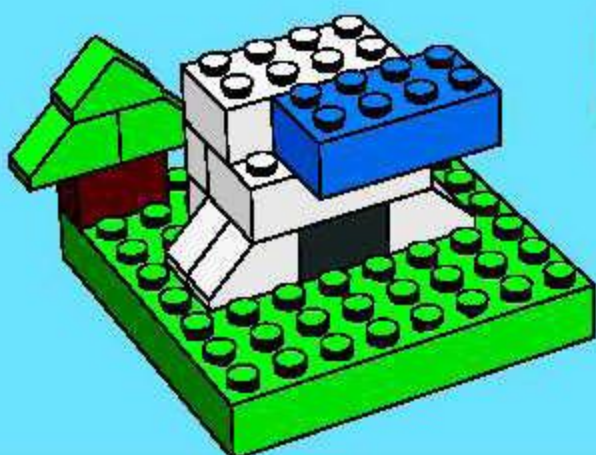

3

4

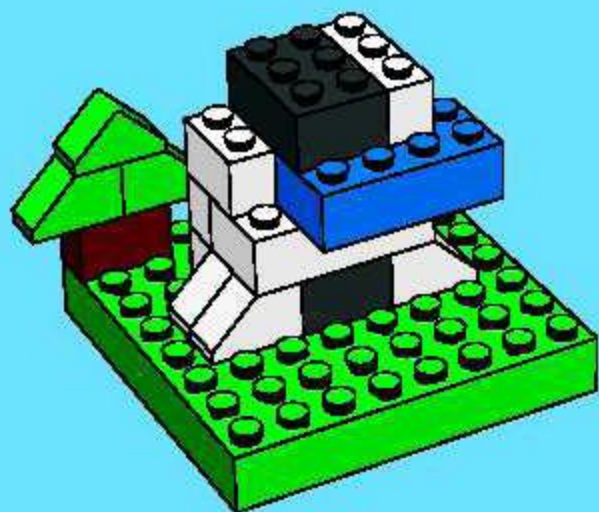

5

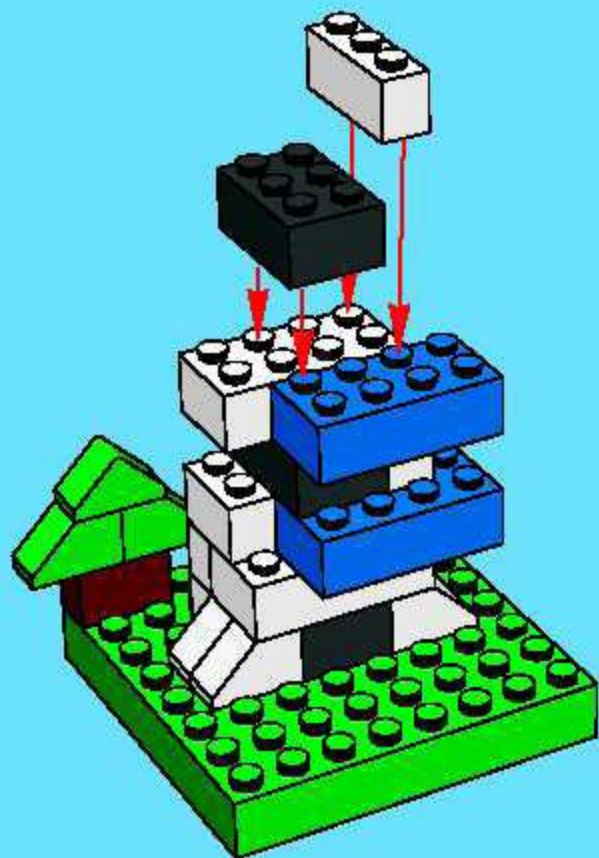

6

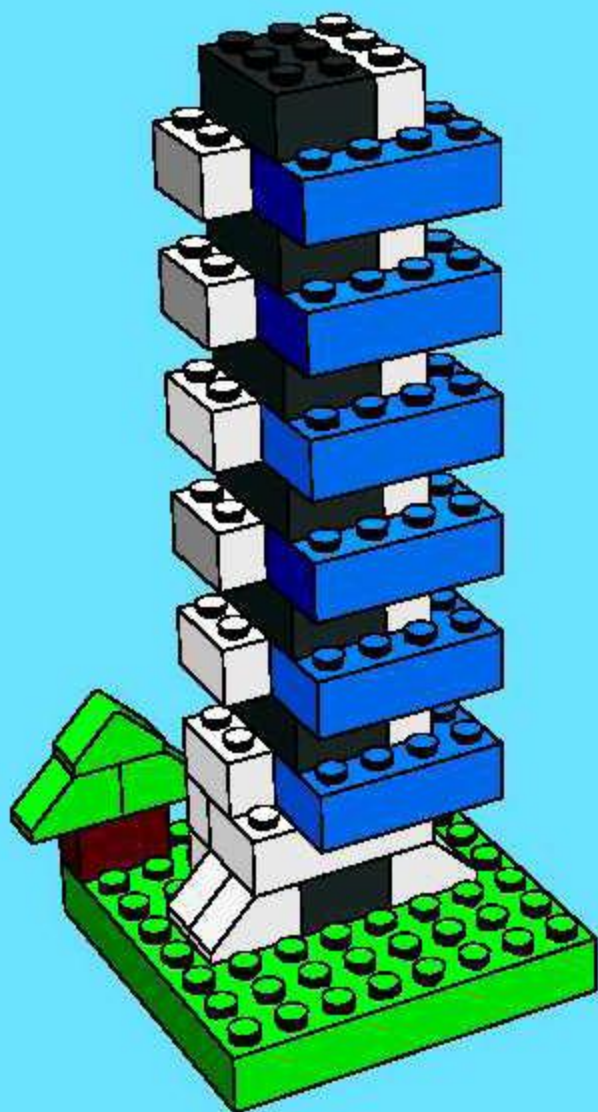

7

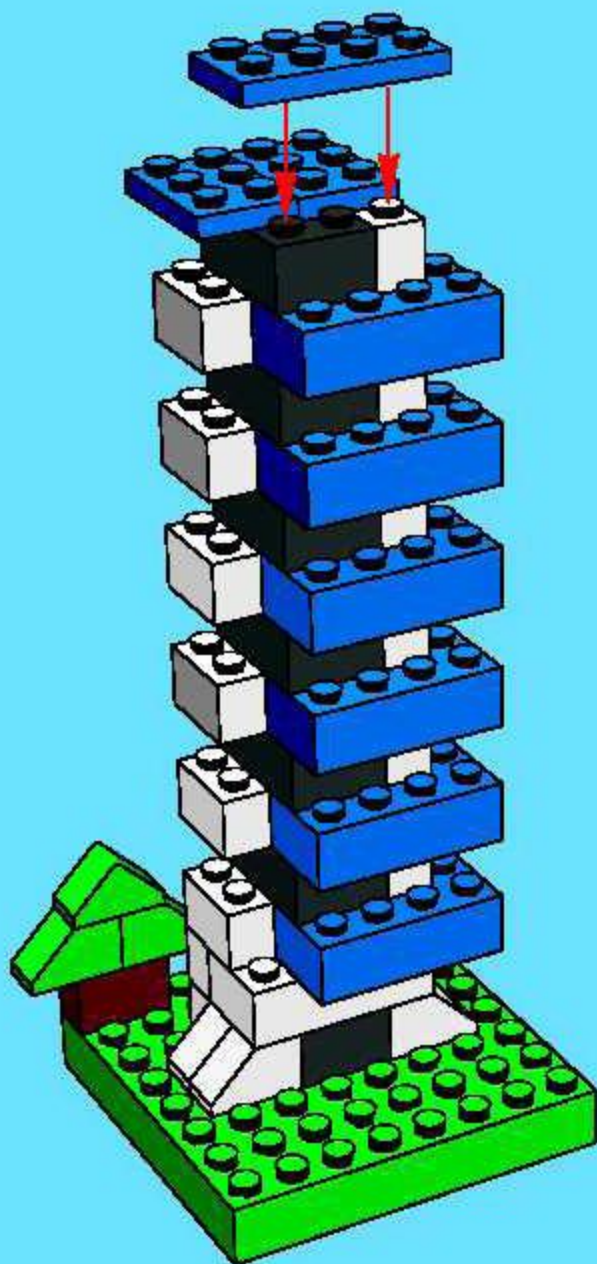

8

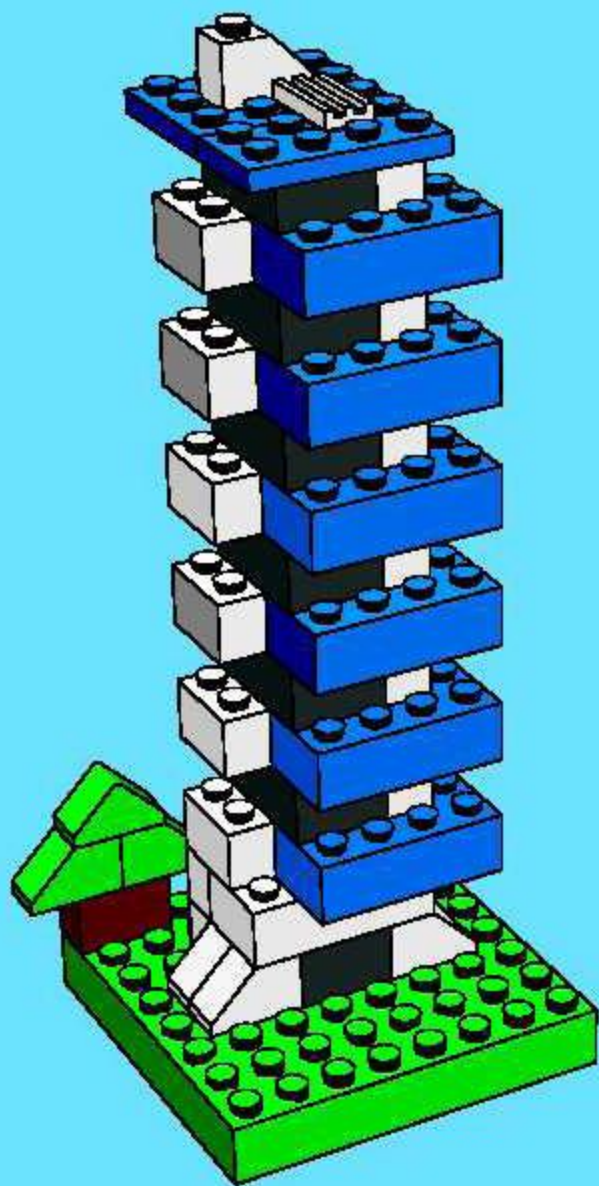





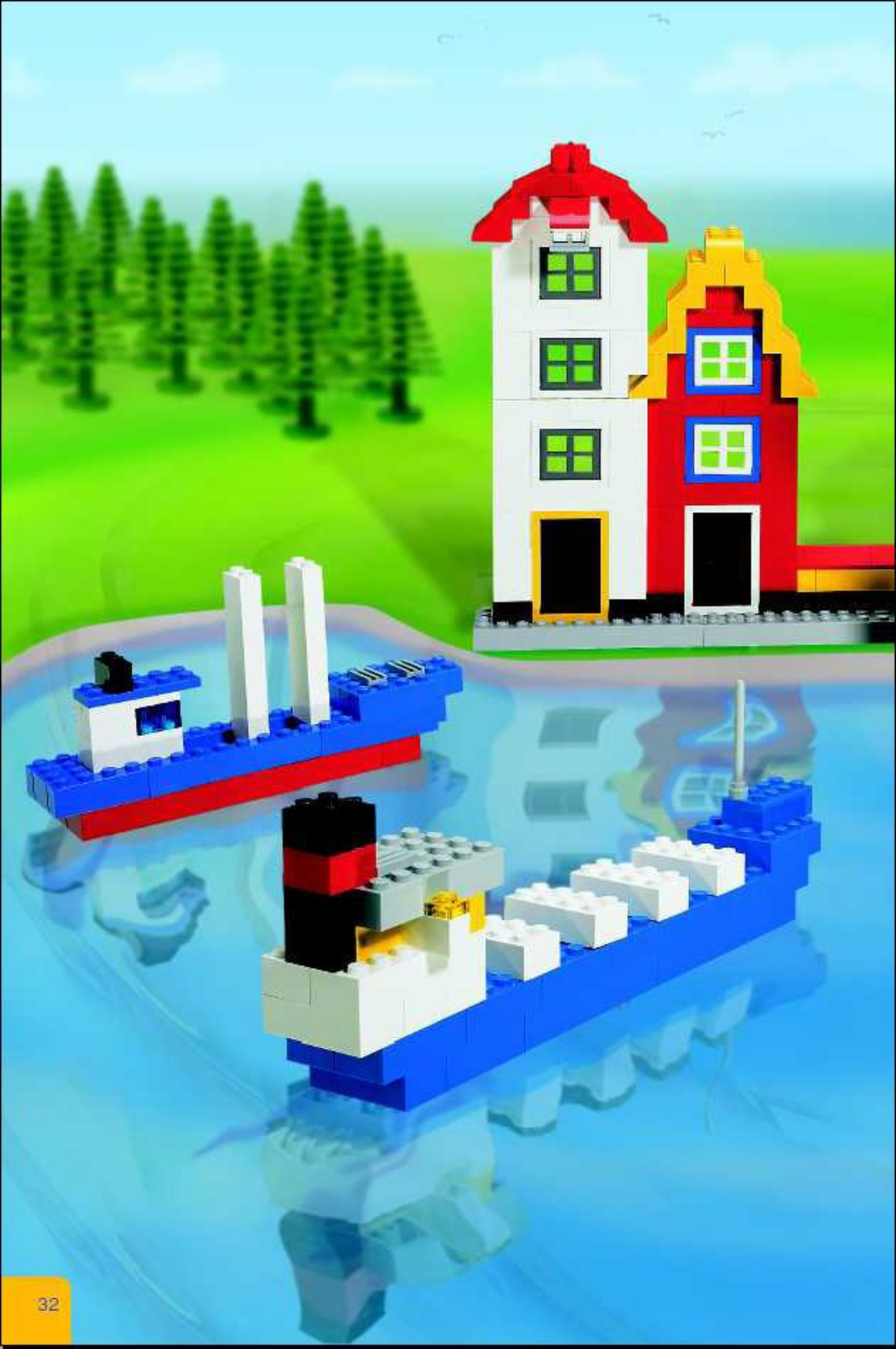





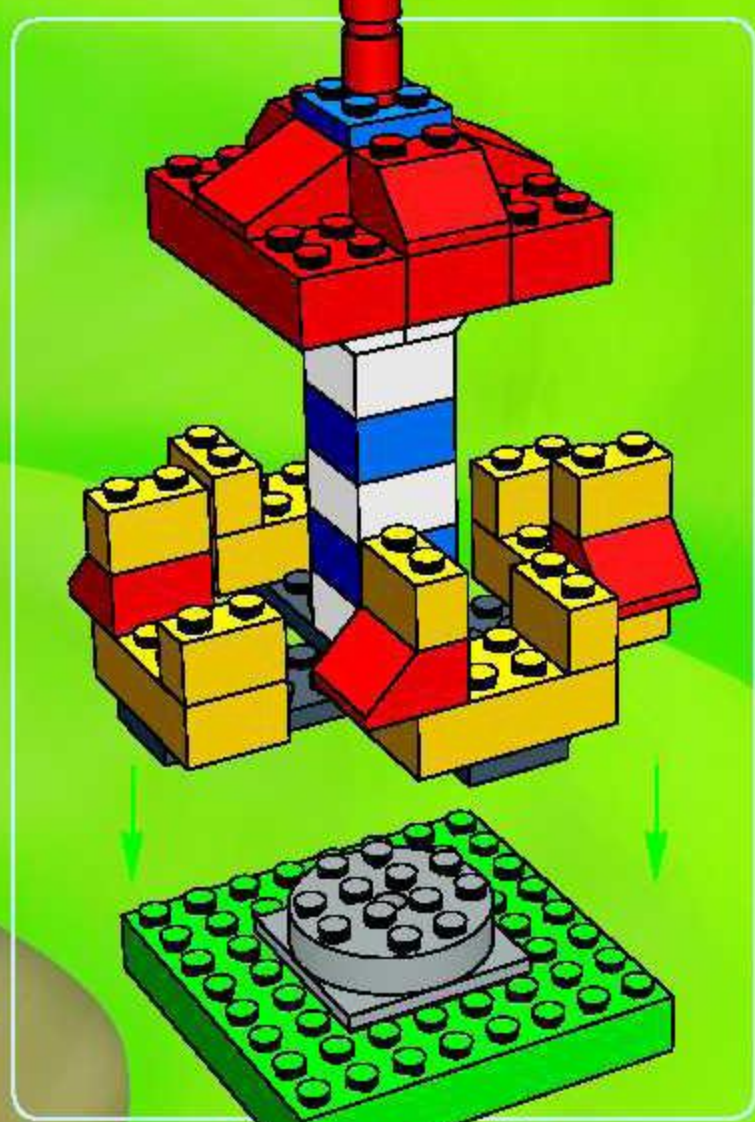



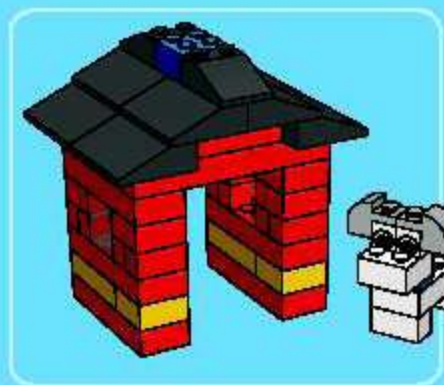

1



2



3

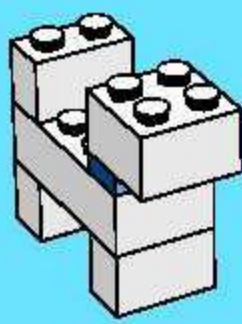

4

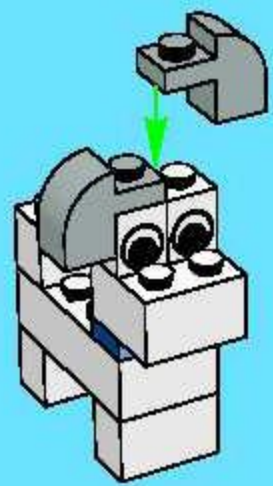

5

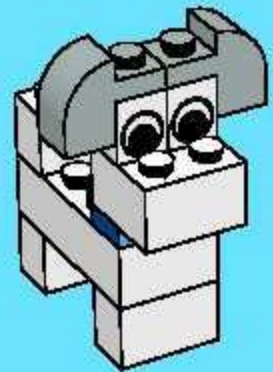

1

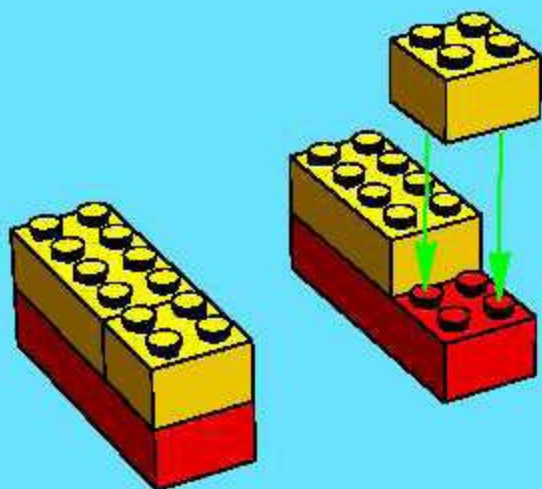

2

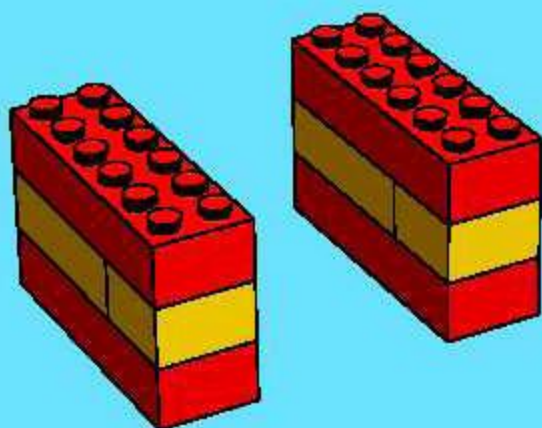

3

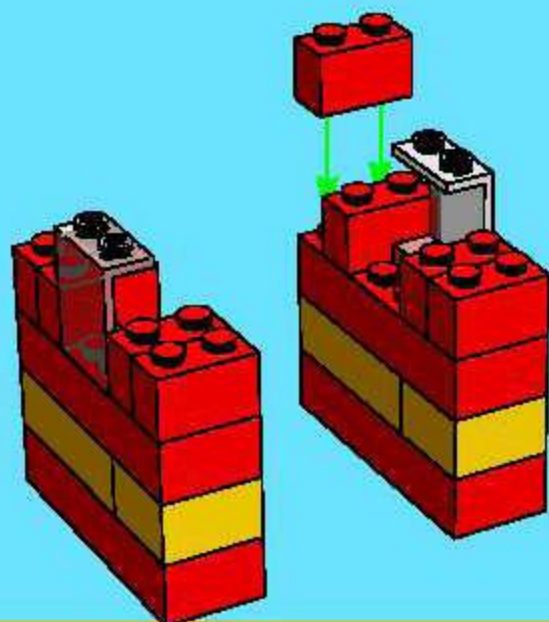

4

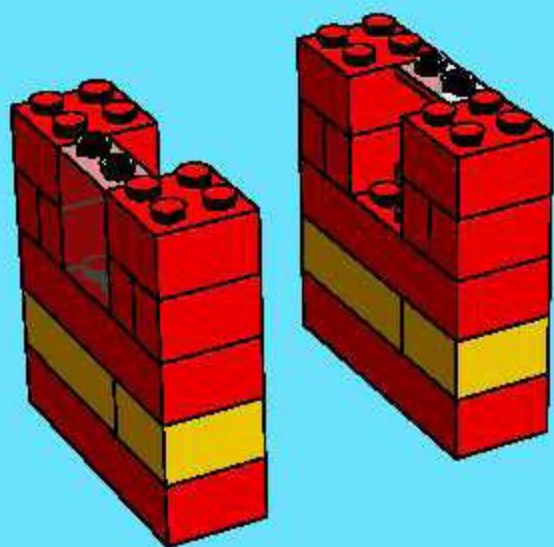

5

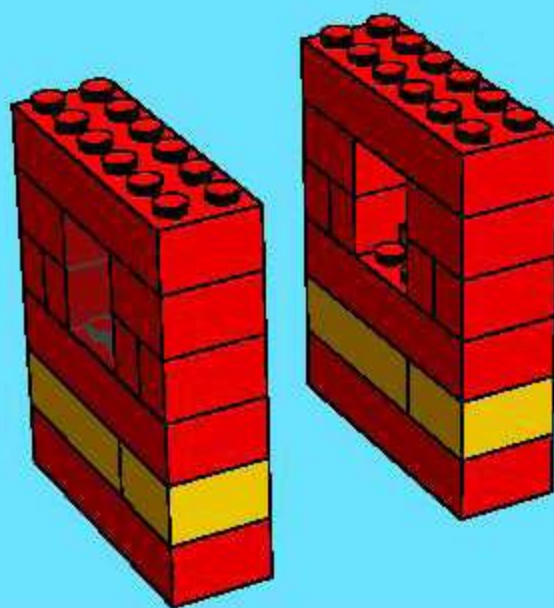

6

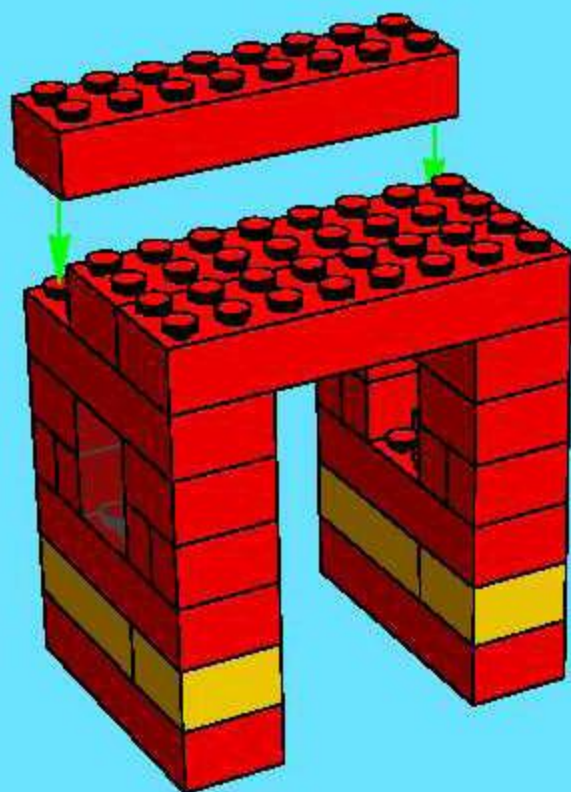

7

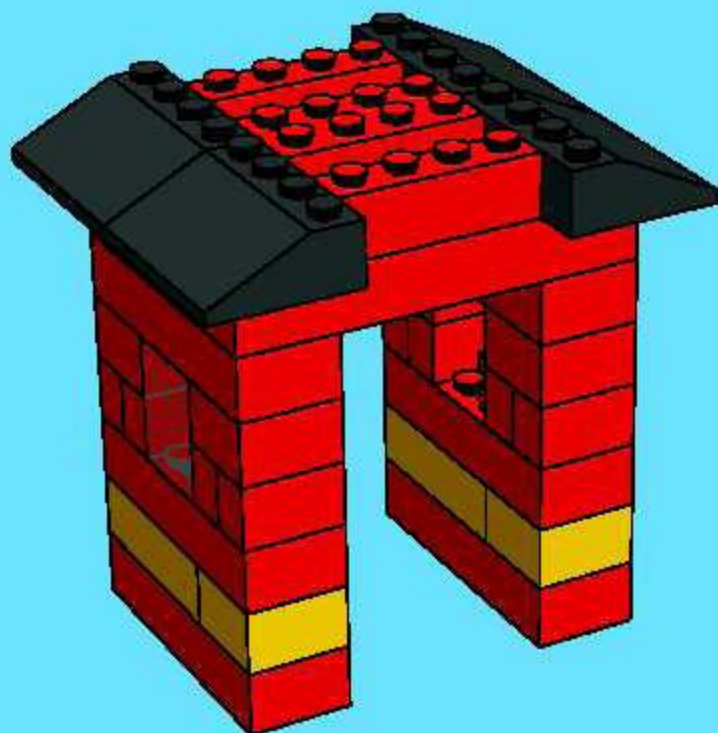

8

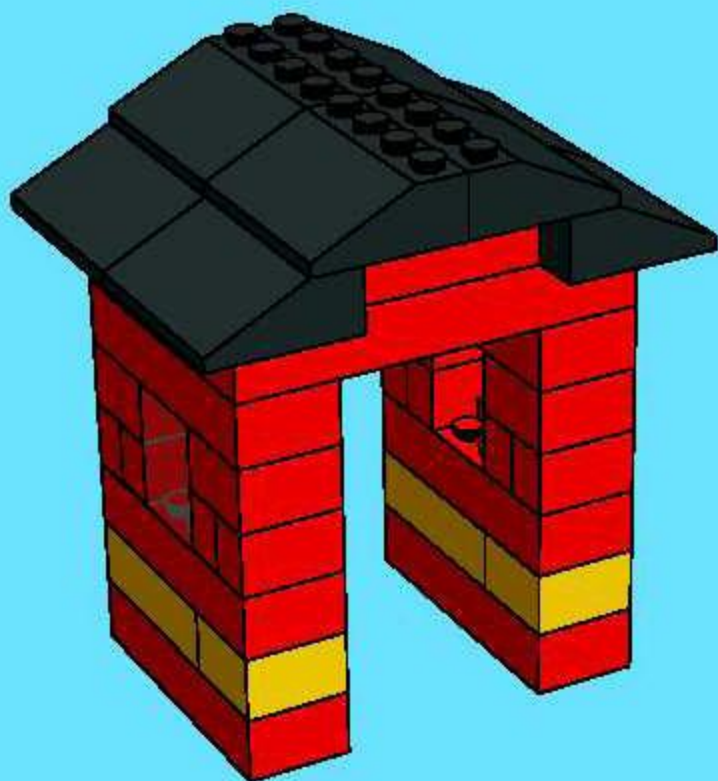

9

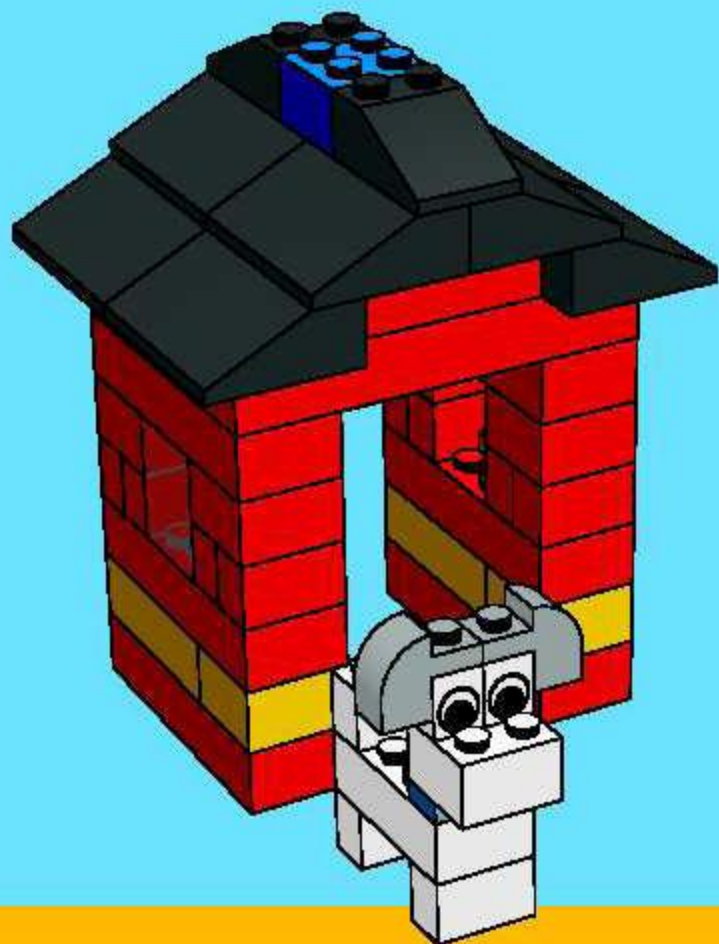









1

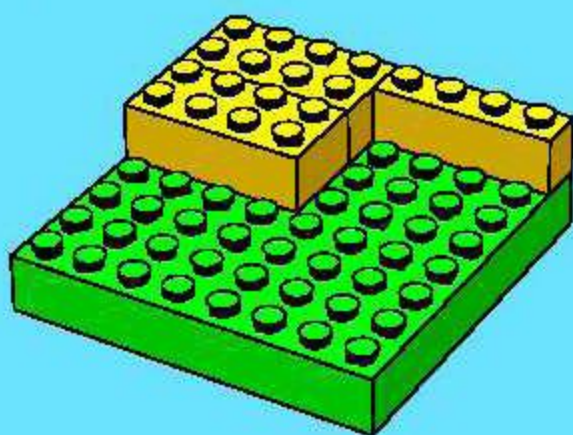

2

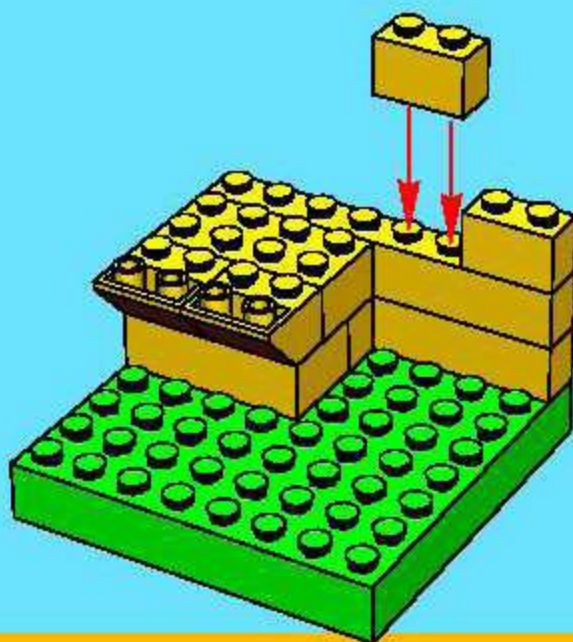

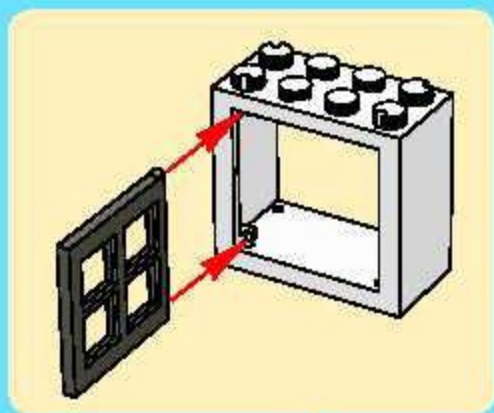

3

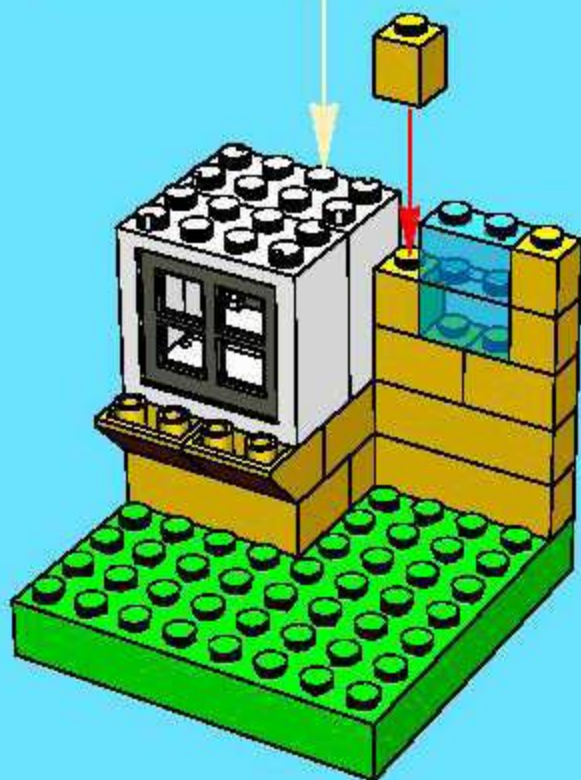

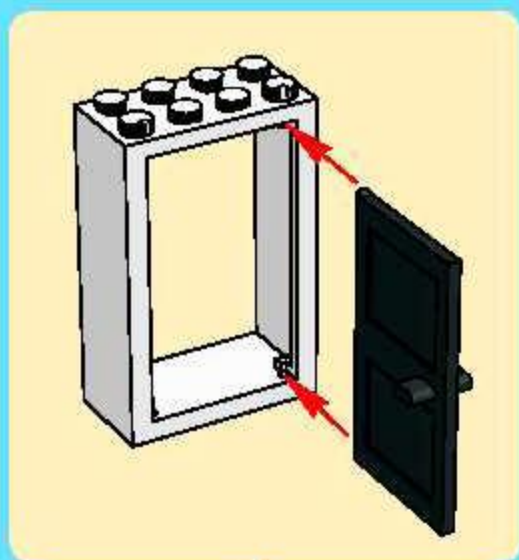

4

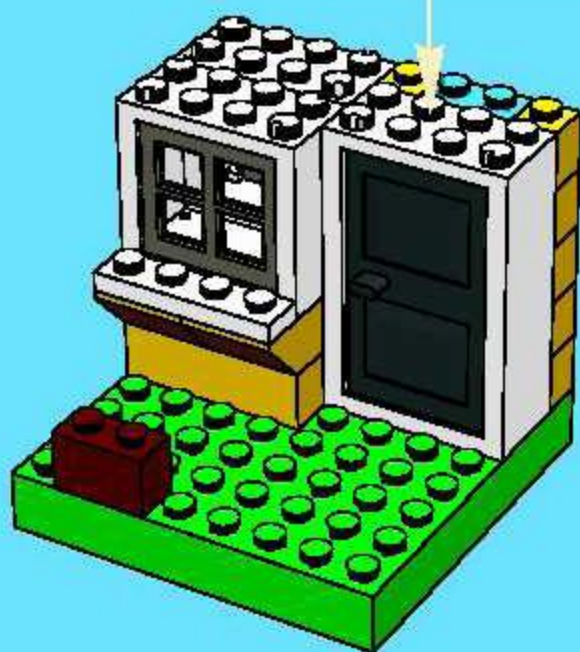

5

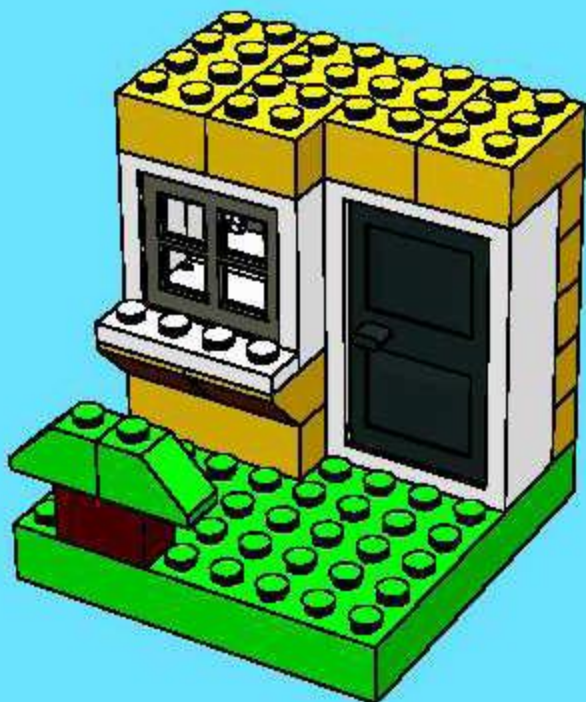

6

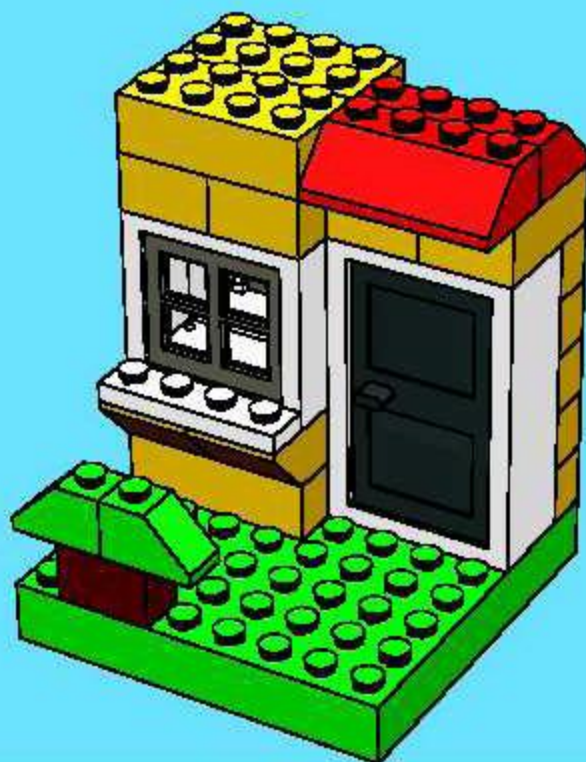

7

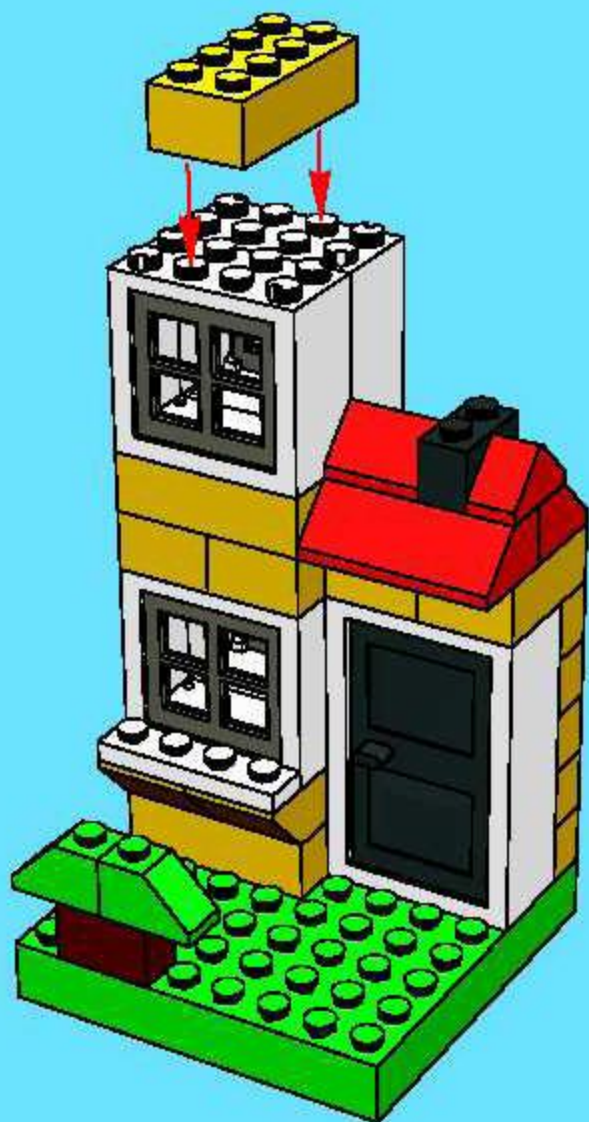

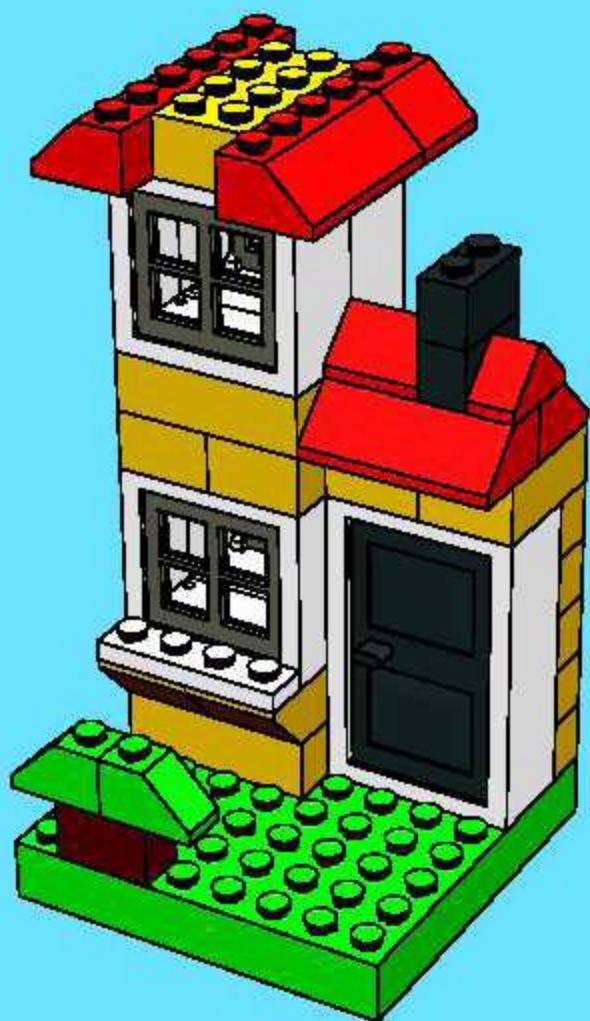

9

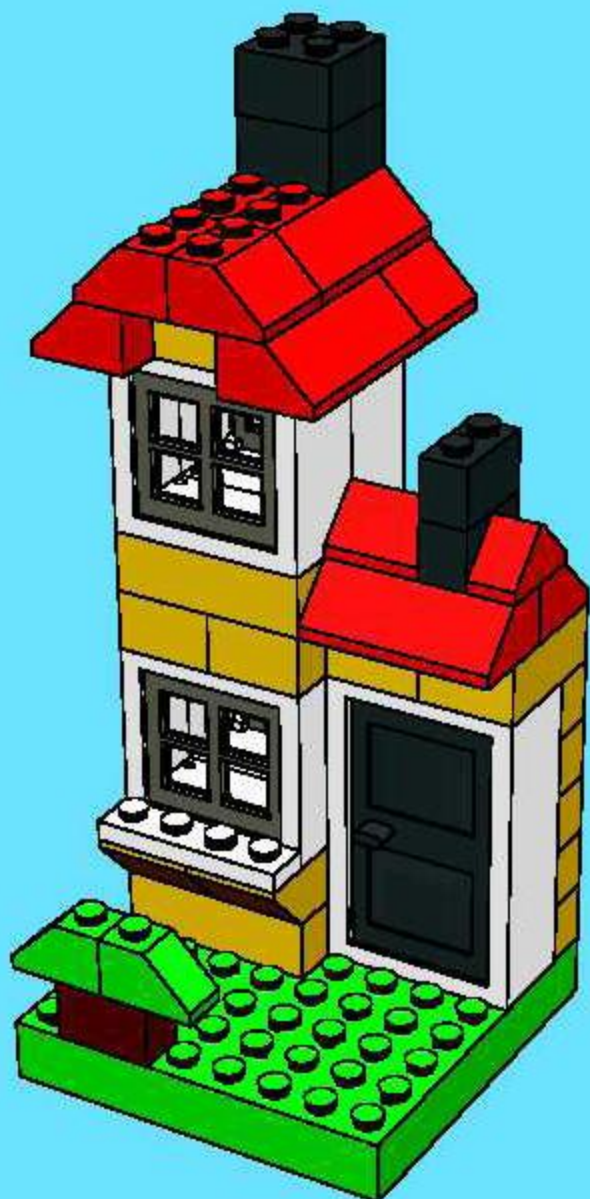

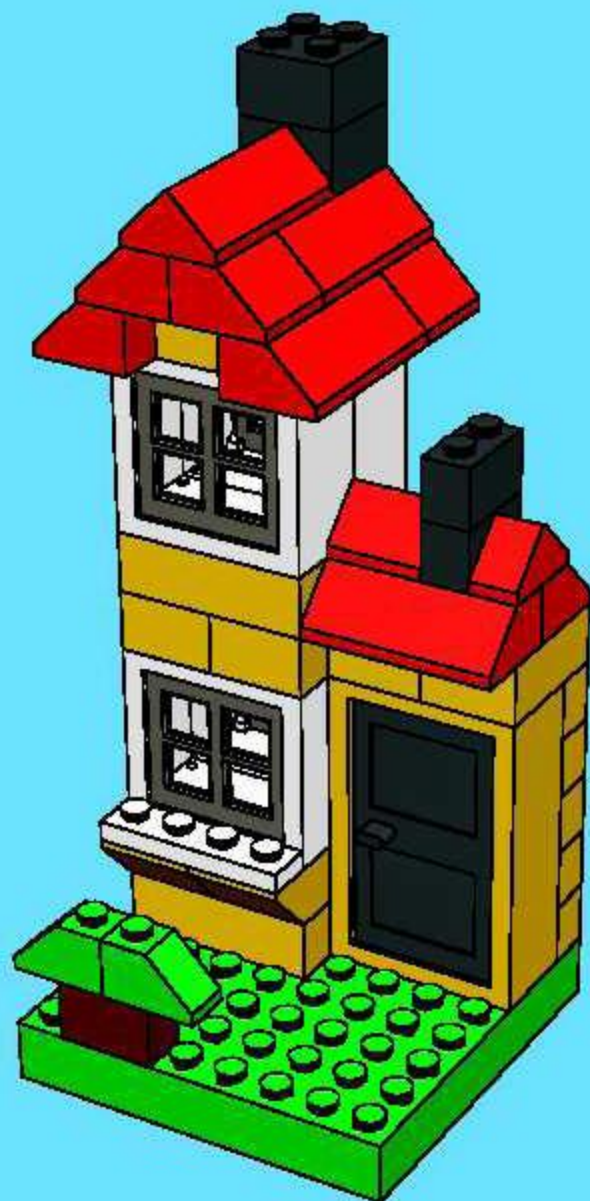









1

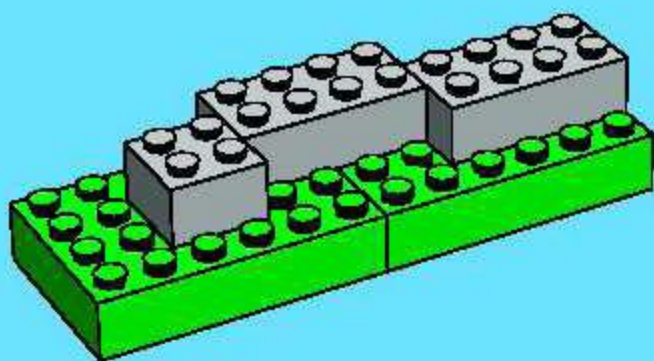

2

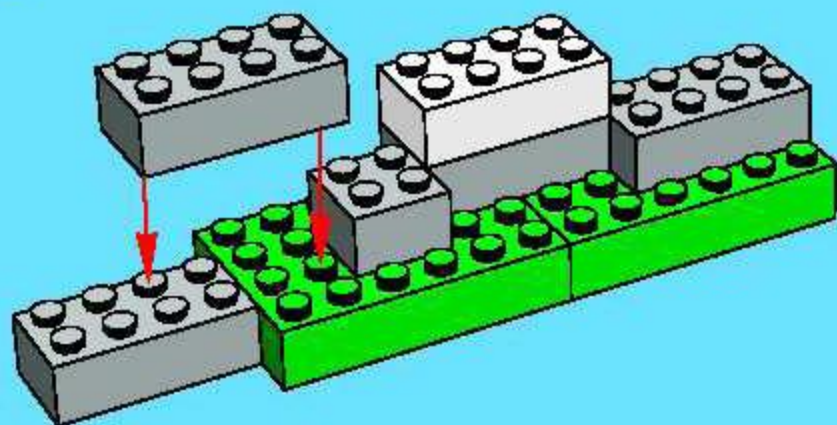

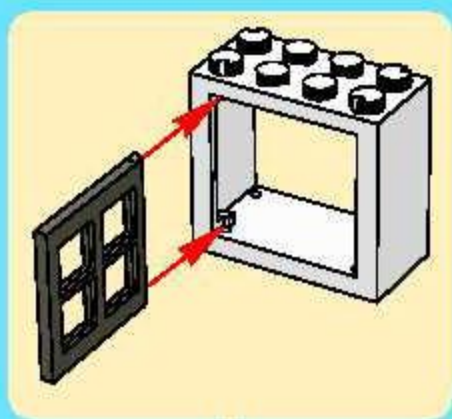

3

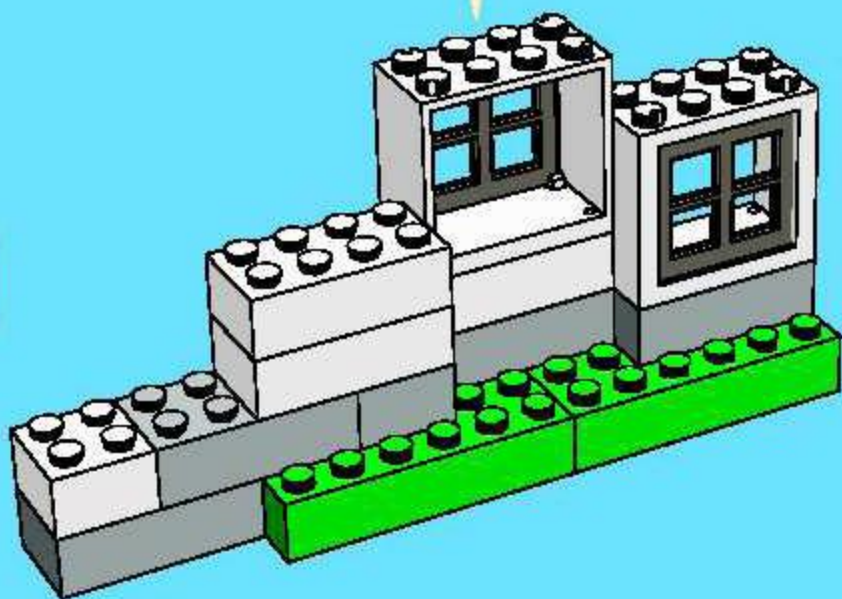

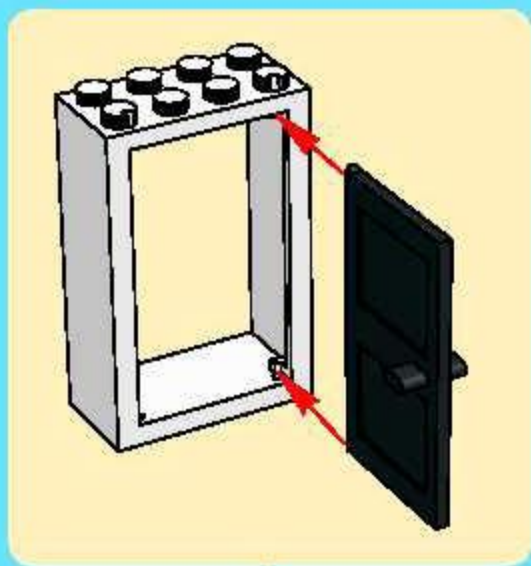

4

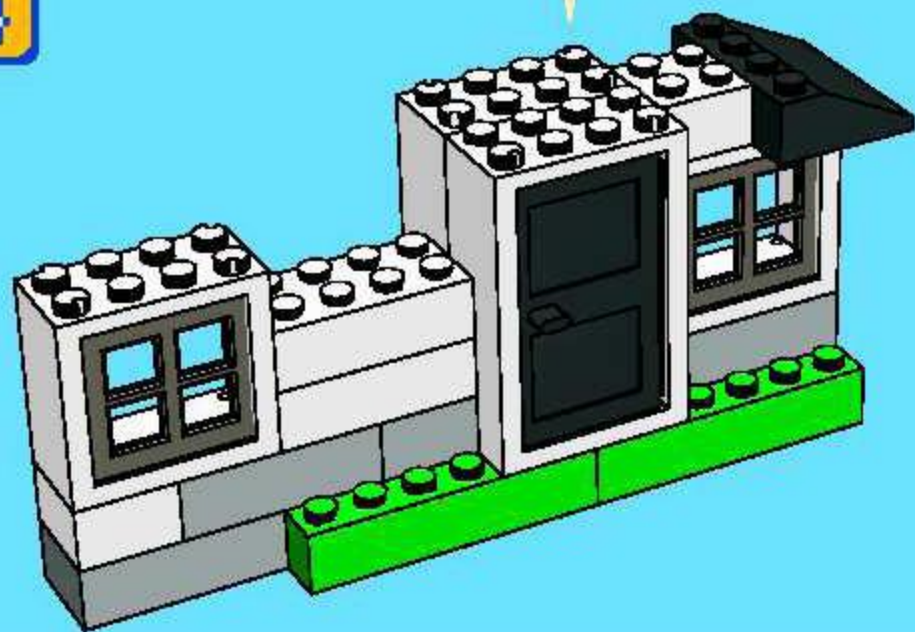

5

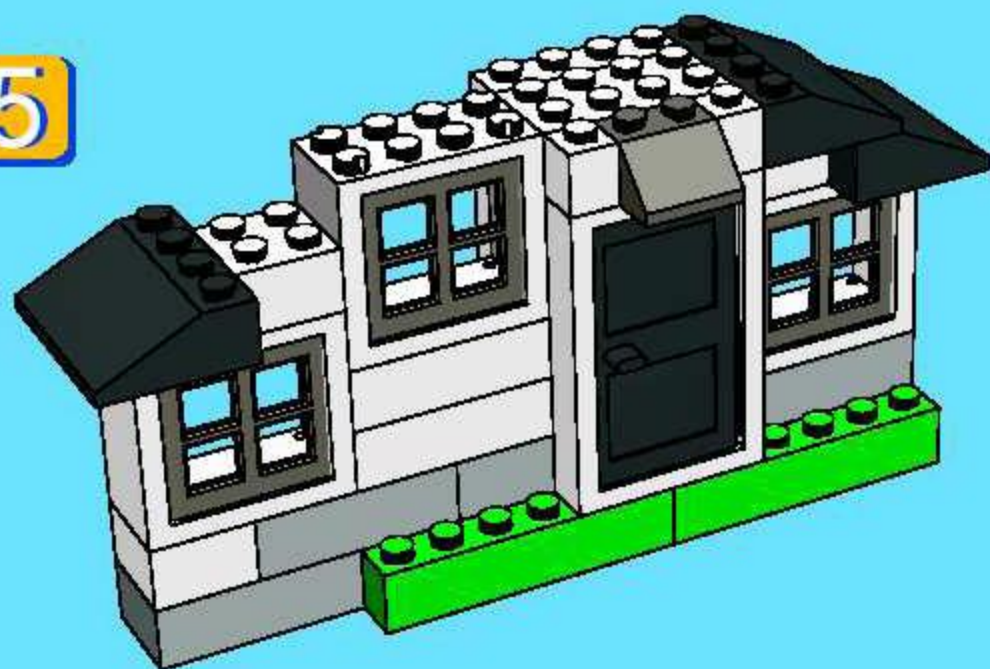

6

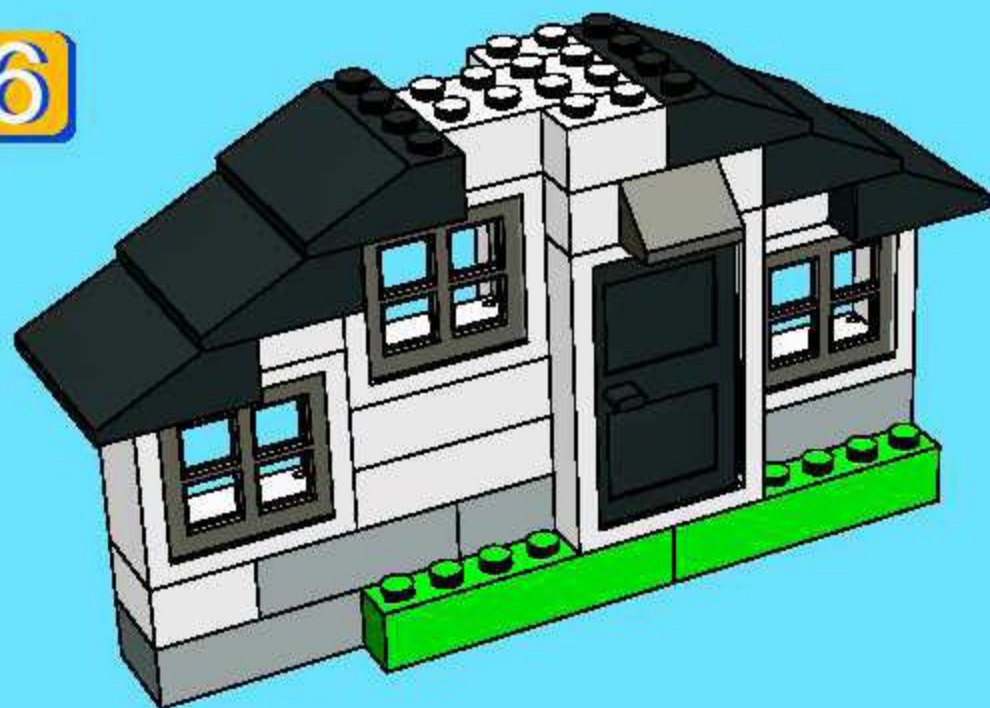

7

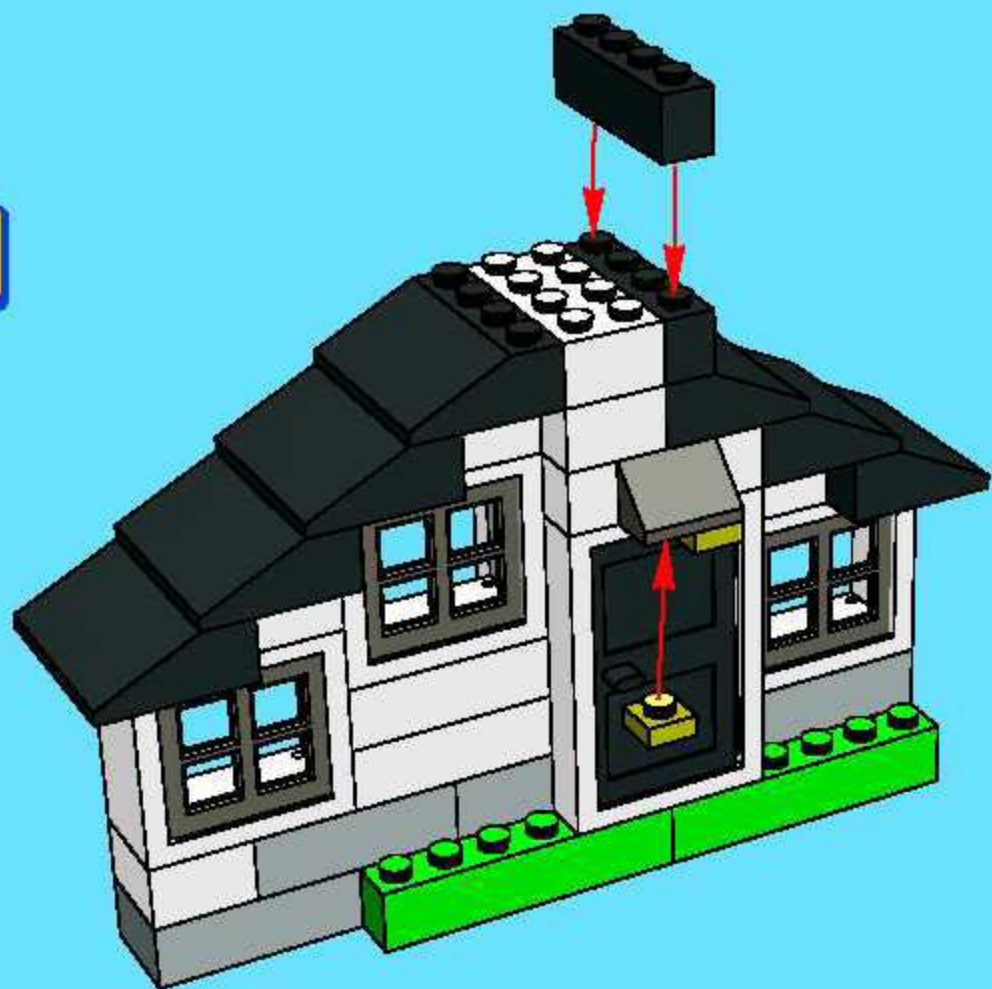

8

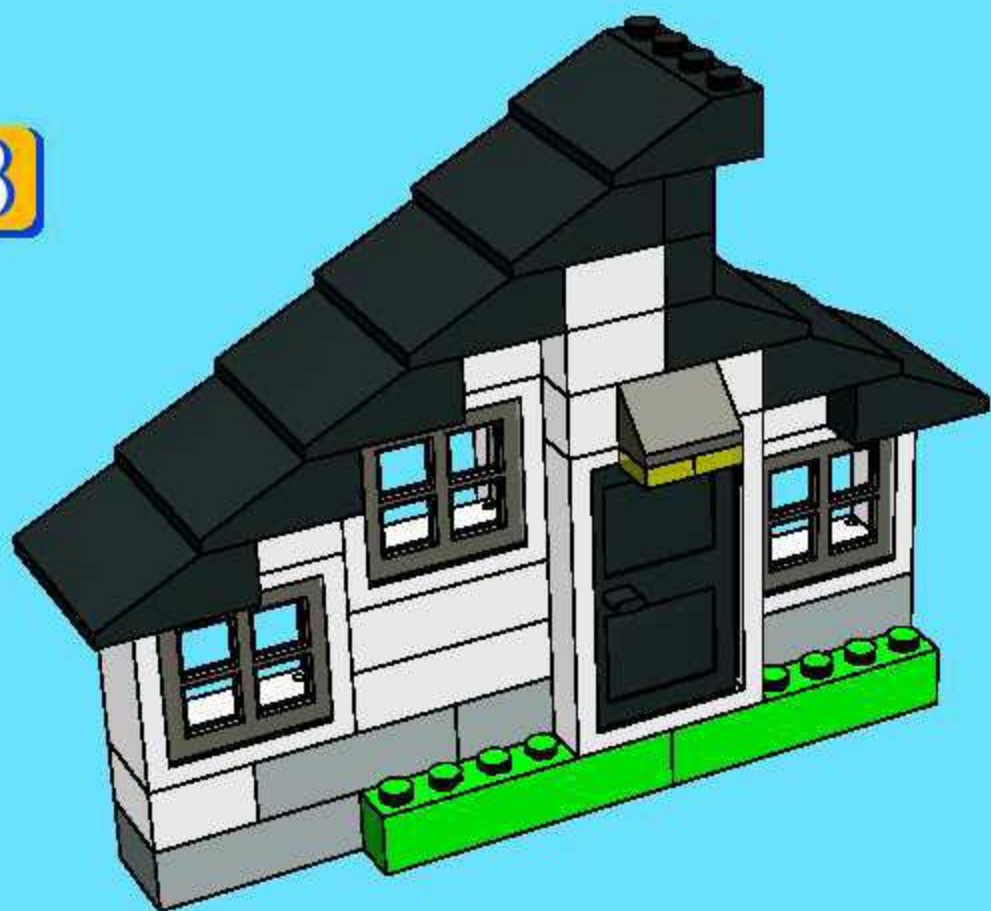

Discover the LEGO UNIVERSE!



www.LEGOuniverse.com



LEGO SHOP at HOME

The World's Biggest
LEGO Shop!

English

Deutsch

Français



LEGO Shop: Building Sets

SHOP at HOME

Welcome to
The World's Biggest LEGO Shop!

STAR WARS

NOW AVAILABLE!
ALL NEW EPISODE III SETS!

SAVE BIG
on lots of great sets!

What's New
Check out what's new at LEGO Shop at Home!

Featured Products

LEGO club



Win!
Gagne!
Gewinne!
当たります



WIN LEGO® PRODUCTS

We would like to know what you think about our new LEGO® product. If you could help us by answering a few questions you are in with a chance of winning an exciting LEGO prize. It will only take you about 3 minutes! Log on to the web address below for further instructions.

We would really like to hear what you think about your new LEGO product. If you'd like to help us, go to the web address below for further instructions.



GAGNE DES PRODUITS LEGO®

Nous aimerions savoir ce que tu penses de ton nouveau produit LEGO®. Si tu veux bien nous aider en répondant à quelques questions, tu recevras peut-être bientôt un fantastique prix LEGO. Et cela ne te prendra que 3 minutes environ ! Tu obtiendras davantage d'informations en visitant le site Internet indiqué ci-dessous.

Nous aimerions savoir ce que tu penses de ton nouveau produit LEGO. Si tu souhaites nous aider, rends-toi à l'adresse Internet ci-dessous où tu trouveras des instructions supplémentaires.



Estimado usuario LEGO®

Al contestar algunas preguntas en Inglés, francés, alemán o japonés, en el sitio www.acnielsen.aim.dk/lego, podrás participar en el sorteo de algunas valiosas premios LEGO®.



GEWINNE LEGO® PRODUKTE

Wir sind sehr an deiner Meinung über dein neues LEGO® Produkt interessiert. Wenn du uns den Gefallen tust und ein paar Fragen beantwortest, kannst du einen tollen LEGO Preis gewinnen. Das Ganze dauert nur etwa 3 Minuten! Gehe einfach zu der unten angegebenen Webadresse - dort findest du weitere Informationen.

Wir möchten gerne wissen, was Sie von Ihrem neuen LEGO Produkt halten. Wenn Sie uns helfen möchten, besuchen Sie bitte die u.a. Website, auf der Sie alles Weitere erfahren.



Cara Consumidor da LEGO®

Ao responder a algumas perguntas em Inglês, Francês, Alemão ou Japonês no endereço www.acnielsen.aim.dk/lego irá participar num concurso para ganhar valiosos prémios da LEGO®.



Kedves Új LEGO® Vásárló

Ha ellátogat az www.acnielsen.aim.dk/lego honlapra és ott angol, francia, német vagy japán nyelven megválaszolsz néhány kérdést, akkor részt veszel egy versenyben, amelyben értékes LEGO® díjakat nyerhetsz.



日本でレゴ®製品が当たります

私たちは、皆さんが買い求めたレゴ®製品についてどんな感想をお持ちか、知りたいと思っています。質問に答えて、楽しいレゴ®製品の抽選にのめり込んでみましょう。アンケートの回答には、抽選で素敵な賞品が当たるかも！詳しくは、以下のウェブアドレスまでアクセスしてください。



www.acnielsen.aim.dk/LEGO



LEGO, the LEGO logo, the CLIKT logo and BIONICLE are trademarks of the LEGO Group. ©2005 The LEGO Group.



www.LEGO.com

